



WWW.RADIOHOBBY.EU

# YAESU

## FT-847

### HF & V/UHF Band Transceiver

### Technical Supplement

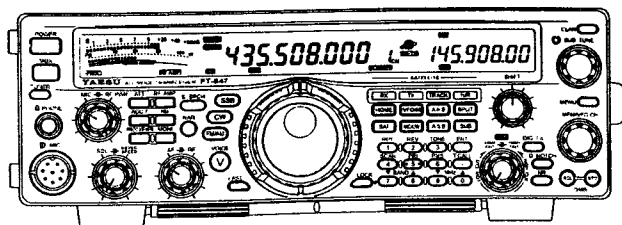

**VERTEX STANDARD CO., LTD.**

4-8-8 Nakameguro, Meguro-Ku, Tokyo 153-8644, Japan

**VERTEX STANDARD**

**US Headquarters**

17210 Edwards Rd., Cerritos, CA 90703, U.S.A.

**International Division**

8350 N.W. 52nd Terrace, Suite 201, Miami, FL 33166, U.S.A.

**YAESU EUROPE B.V.**

P.O. Box 75525, 1118 ZN Schiphol, The Netherlands

**YAESU UK LTD.**

Unit 12, Sun Valley Business Park, Winnall Close  
Winchester, Hampshire, SO23 0LB, U.K.

**YAESU GERMANY GmbH**

Am Kronberger Hang 2, D-65824 Schwalbach, Germany

**VERTEX STANDARD HK LTD.**

Unit 5, 20/F., Seaview Centre, 139-141 Hoi Bun Road,  
Kwun Tong, Kowloon, Hong Kong

# Contents

<i>Introduction</i> .....	1-1
<i>Specifications</i> .....	1-2
<i>Chip Component Information</i> .....	1-3
<i>Mechanical Details (Exploded Views &amp; Mechanical Parts)</i> .....	2-1
<i>Alignment</i> .....	3-1
<i>Block &amp; Interconnection Diagrams</i> .....	4-1
<i>PCB Diagrams &amp; Parts List</i>	
AF-CNTL Unit .....	5A-1
PLL Unit .....	5B-1
RF Unit .....	5C-1
V/U-PA Unit .....	5D-1
PA Unit .....	5E-1
DSP Unit .....	5F-1
Panel Unit .....	5G-1
SSB-Filter-1/-2 Unit .....	5H-1
Phone-Jack Unit .....	5 I-1
Mic Unit .....	5 J-1
HPF Unit .....	5K-1

Cut out the label at the right, and place it behind the clear plastic window in the spine of a binder.

 **FT-847**  
**Technical Supplement**

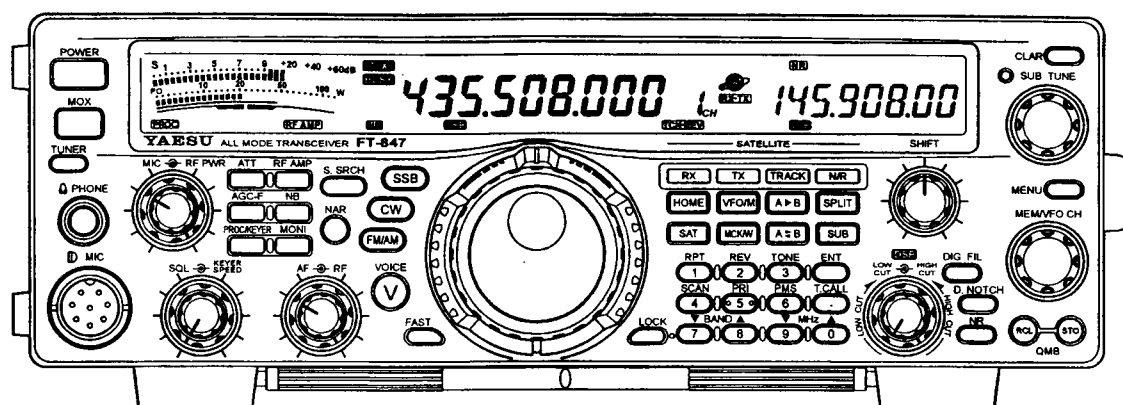

This manual provides technical information necessary for servicing the Yaesu FT-847 HF & V/UHF-Band Transceiver. It does not include information on installation and operation, which are described in the FT-847 Operating Manual provided with the transceiver, or on accessories which are described in their manuals.

The FT-847 is carefully designed to allow the knowledgeable operator to make nearly all adjustments required for various station conditions, modes and operator preferences simply from the controls on the panels, without opening the case of the transceiver. The FT-847 Operating Manual describes these adjustments, plus certain internal settings.

Servicing this equipment requires expertise in handling surface mount chip components. Attempts by unqualified persons to service this equipment may result in permanent damage not

covered by warranty. For the major circuit boards, each side of the board is identified by the type of the majority of components installed on that side. In most cases one side has only chip components, and the other has either a mixture of both chip and lead components (trimmers, coils, electrolytic capacitors, packaged ICs, etc.), or lead components only.

While we believe the technical information in this manual is correct, Yaesu assumes no liability for damage that may occur as a result of typographical or other errors that may be present. Your cooperation in pointing out any inconsistencies in the technical information would be appreciated. Yaesu Musen reserves the right to make changes in this transceiver and the alignment procedures, in the interest of technological improvement, without notification of owners.

# Specifications

## General

Frequency Range:	Receive 100 kHz ~ 30 MHz, 36 MHz ~ 76 MHz, 108 MHz ~ 174 MHz, 420 MHz ~ 512 MHz Transmit 160 ~ 6 Meters, 2 Meters, 70 Centimeters (Amateur bands only) 5.1675 MHz (Alaska Emergency Channel)
Emission Modes:	USB, LSB, CW, AM, FM F1 (9600 bps Packet), F2 (1200 bps Packet), AFSK
Synthesizer Steps (Min.):	0.1 Hz (CW, SSB), 10 Hz (AM, FM)
Antenna Impedance:	50-Ω, Unbalanced
Operating Temp. Range:	-10 °C to +50 °C (14 °F to 122 °F)
Frequency Stability:	Better than ±2 ppm (0 °C to +40 °C) SSB/CW/AM/AFSK Better than ±5 ppm (-10 °C to +50 °C) SSB/CW/AM/AFSK Better than ± (1 kHz ± 5 ppm) FM
Power Requirements:	DC 13.8 V ±10 %, Negative Ground
Current Consumption:	Receive: 1.5 A (Squelched), 2.0 A (Max. Audio) Transmit: 22 A (@ 100 W RF output)
Case Size:	260 (W) × 86 (H) × 270 (D) mm (10.24" × 3.39" × 10.63")
Weight:	Approximately 7 kg (14.4 lbs.)

## Transmitter

Power Output:	160 ~ 6 m: 100 Watts (25 Watts AM carrier) 2 m/70 cm: 50 Watts (12.5 Watts AM carrier)
Modulation Types:	SSB: Balanced Modulator FM: Variable Reactance AM: Early Stage (Low Level)
FM Maximum Deviation:	±5 kHz (±2.5 kHz on FM-N)
Spurious Radiation:	Harmonics: At least 40 dB down (1.8 ~ 29.7 MHz) At least 60 dB down (50/144/430 MHz) Non-harmonic: At least 50 dB down (1.8 ~ 29.7 MHz) At least 60 dB down (50/144/430 MHz)
Carrier Suppression:	At least 40 dB
Opp. Sideband Suppression:	At least 40 dB
3rd-Order IMD:	At least 31 dB down (14 MHz, 100 W PEP output)
SSB Frequency Response:	400 Hz ~ 2600 Hz (-6 dB)
Microphone Impedance:	200 Ω ~ 10 kΩ (Supplied microphone: 600 Ω)

## Receiver

Sensitivity:		SSB/CW	AM-N	FM
	500 kHz ~ 1.8 MHz:	-	20 μV	-
	1.8 ~ 28 MHz:	0.25 μV	2 μV	-
	28 ~ 30 MHz:	0.25 μV	2 μV	0.5 μV
	50 ~ 54 MHz:	0.20 μV	1 μV	0.25 μV
	144/430 MHz:	0.125 μV	-	0.2 μV
<i>(Above specifications are worst-case. SSB/CW/AM-N figures are for 10 dB S/N, 12 dB SINAD on FM)</i>				
Squelch Sensitivity:		SSB/CW/AM	FM	
	500 kHz ~ 1.8 MHz:	20 μV	-	
	1.8 ~ 28 MHz:	2 μV	-	
	28 ~ 30 MHz:	2 μV	0.25 μV	
	50 ~ 54 MHz:	1 μV	0.20 μV	
	144/430 MHz:	0.5 μV	0.16 μV	
Image Rejection:	Better than 60 dB			
IF Rejection:	Better than 60 dB			
Selectivity (-6/-60dB):	SSB/CW:	2.2 kHz/4.5 kHz		
	CW-N:	0.5 kHz/2.0 kHz (Optional YF-115C installed)		
	AM:	9 kHz/20 kHz		
	AM-N:	2.2 kHz/4.5 kHz		
	FM:	15 kHz/30 kHz		
	FM-N:	9 kHz/20 kHz		
Audio Output:	At least 1.5 Ω into 8 W @ 10 % THD			
Audio output impedance:	4 Ω ~ 16 Ω			

Specifications are subject to change, in the interest of improvement, without notice or obligation.  
Specifications are guaranteed only within Amateur bands.

# Chip Component Information

The diagrams below indicate some of the distinguishing features of common chip components.

## Capacitors

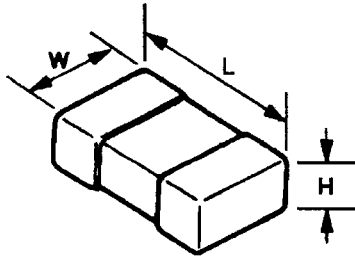

(Unit: mm)

Type	L	W	H
2125	2.0	1.25	0.35 ~ 0.5
1608	1.6	0.8	0.65 ~ 0.95
1005	1.0	0.5	0.45 ~ 0.55

## Tantalum Capacitors

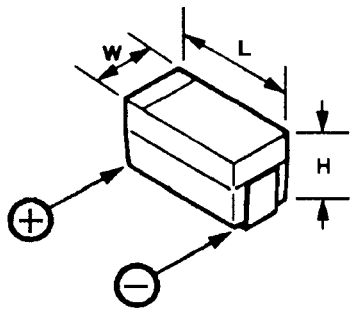

(Unit: mm)

Type	L	W	H
P	2.0	1.25	1.2
A	3.2	1.6	1.6
B	3.4	2.8	1.9
C	5.8	3.2	2.3

## Resistors

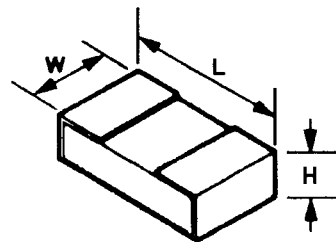

Marking\* 100, 222, 473...

473

Tens	Ones	Multiplier
0	0	10 <sup>0</sup>
1	1	10 <sup>1</sup>
2	2	10 <sup>2</sup>
3	3	10 <sup>3</sup>
4	4	10 <sup>4</sup>
5	5	10 <sup>5</sup>
6	6	10 <sup>6</sup>
7	7	10 <sup>7</sup>
8	8	10 <sup>8</sup>
9	9	10 <sup>9</sup>

Indicated Letters

**1 2 3 4 5 6 7 8 9 0 .**

(Unit: mm)

Type	L	W	H
1/10	2.0	1.25	0.5
1/16	1.6	0.8	0.45
1/16S	1.0	0.5	0.35

Examples: 100=10Ω  
222=2.2kΩ  
473=47kΩ

# Chip Component Information

## Replacing Chip Components

Chip components are installed at the factory by a series of robots. The first one places a small spot of adhesive resin at the location where each part is to be installed, and later robots handle and place parts using vacuum suction.

For single sided boards, solder paste is applied and the board is then baked to harden the resin and flow the solder. For double sided boards, no solder paste is applied, but the board is baked (or exposed to ultra-violet light) to cure the resin before dip soldering.

In our laboratories and service shops, small quantities of chip components are mounted manually by applying a spot of resin, placing the components with tweezers, and then soldering by very small dual streams of hot air (without physical contact during soldering). We remove parts by first removing solder using a vacuum suction iron, which applies a light steady vacuum at the iron tip, and then breaking the adhesive with tweezers.

Special vacuum/desoldering equipment is recommended if you expect to do a lot of chip replacements. Otherwise, it is usually possible to remove and replace chip components with only a tapered, temperature-controlled soldering iron, a set of tweezers and braided copper solder wick. Soldering iron temperature should be below 280°C (536°F).

## Precautions for Chip Replacement

- Do not disconnect a chip forcefully, or the foil pattern may peel off the board.
- Never re-use a chip component. Dispose of all removed chip components immediately to avoid mixing with new parts.
- Limit soldering time to 3 seconds or less to avoid damaging the component and board.

## Removing Chip Components

- Remove the solder at each joint, one joint at a time, using solder wick whetted with non-acidic fluxes as shown below. Avoid applying pressure, and do not attempt to remove tinning from the chip's electrode.

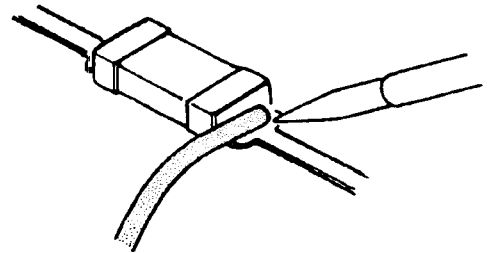

- Grasp the chip on both sides with tweezers, and gently twist the tweezers back and forth (to break the adhesive bond) while alternately heating each electrode. Be careful to avoid peeling the foil traces from the board. Dispose of the chip when removed.
- After removing the chip, use the copper braid and soldering iron to wick away any excess solder and smooth the land for installation of the replacement part.

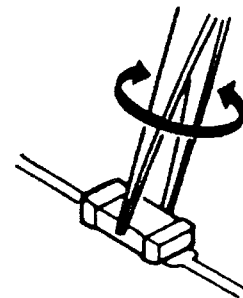

## Chip Component Information

### *Installing a Replacement Chip*

As the value of some chip components is not indicated on the body of the chip, be careful to get the right part for replacement.

- Apply a small amount of solder to the land on one side where the chip is to be installed. Avoid too much solder, which may cause bridging (shorting to other parts).

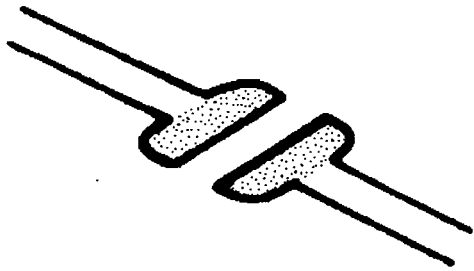

- Hold the chip with tweezers in the desired position, and apply the soldering iron with a motion line as indicated by the arrow in the diagram below. Do not apply heat for more than 3 seconds.

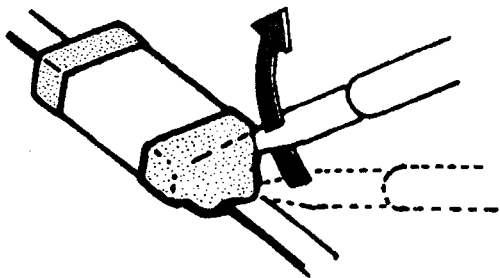

- Remove the tweezers and solder the electrode on the other side in the manner just described.





# Exploded View & Miscellaneous Parts

REF.	DESCRIPTION	VALUE	V/W	TOL.	MFR'S DESIG	YAESU P/N	VERS.	LOT.
*** MAIN ASSY ***								
C 0001	AL.ELECTRO.CAP.	100uF	16V		RE3-16V101M 100UF	K40129063		1-
FN0001	FAN				A0512 DC12V	M2090017		1-
FN0001	FAN				F412R-12MB-32 DC12V	M2090028		8-
FN0002	FAN				JF0625S1M-050 DC12V	M2090023		1-
FN0002	FAN				JF0625S1M-050R1 DC12V	M2090029		16-
J 0001	CONNECTOR				FM-MDR-MI	P1090352		1-
J 0002	CONNECTOR				FM-MDR-MI	P1090352		1-
J 0003	CONNECTOR				FM-MDR-MI	P1090352		1-
J 0004	CONNECTOR				020-0291	P1090547		1-
JP0001	WIRE ASSY				GRN 280 (2)/(2)	T51528002	UNITED KINGDOM	8-
P 0001	WIRE ASSY				A1179	T9206718		1-
P 0002	WIRE ASSY				A1179	T9206702		1-
P 0002	WIRE ASSY				A1179	T9206702A		5-
P 0003	WIRE ASSY				A1179	T9206703		1-
P 0003	WIRE ASSY				A1179	T9206703A		5-
P 0004	WIRE ASSY				A1179	T9206704		1-
P 0004	WIRE ASSY				A1179	T9206704A		5-
P 0005	WIRE ASSY				A1179	T9206705		1-
P 0005	WIRE ASSY				A1179	T9206705A		2-
P 0005	WIRE ASSY				A1179	T9206705B		5-
P 0006	WIRE ASSY				A1179	T9206706		1-
P 0006	WIRE ASSY				A1179	T9206706A		2-
P 0007	WIRE ASSY				RED 280/400 V5.5	T9318054		1-
P 0008	WIRE ASSY				BLK 280/360 V5.5	T9318055		1-
P 0009	WIRE ASSY				GRA 280 TMP/TMP	T9311201		1-
P 0010	WIRE ASSY				A1179	T9206707		1-
P 0010	WIRE ASSY				A1179	T9206707A		5-
P 0011	WIRE ASSY				A1179	T9206708		1-
P 0011	WIRE ASSY				A1179	T9206708A		5-
P 0012	WIRE ASSY				A1179	T9206710A		1-
P 0012	WIRE ASSY				A1179	T9206710B		5-
P 0012	WIRE ASSY				A1179	T9206710C		7-
P 0013	WIRE ASSY				A1179	T9206709A		1-
P 0013	WIRE ASSY				A1179	T9206709B		5-
P 0013	WIRE ASSY				A1179	T9206709C		7-
P 0014	WIRE ASSY				A1179	T9206711		1-
P 0014	WIRE ASSY				A1179	T9206711A		5-
P 0015	WIRE ASSY				A1179	T9206712		1-
P 0015	WIRE ASSY				A1179	T9206712A		5-
P 0016	WIRE ASSY				BRN 330 TMP/TMP	T9318041		1-
P 0017	WIRE ASSY				YEL 210 TMP/TMP	T9318042		1-
P 0018	WIRE ASSY				BLK 340 TMP/TMP	T9318043		1-
P 0018	WIRE ASSY				BLK 360 TMP/TMP	T9318056		2-
P 0019	WIRE ASSY				ORG 200 TMP/TMP	T9318044		1-
P 0020	WIRE ASSY				A1179	T9206713		1-
P 0020	WIRE ASSY				A1179	T9206713A		5-
P 0021	WIRE ASSY				A1179	T9206714		1-
P 0022	WIRE ASSY				BLK 60 TMP/TMP	T9318045		1-
P 0022	WIRE ASSY				RED 60 TMP/TMP	T9318059		2-
P 0023	WIRE ASSY				ORG 120 TMP/TMP	T9318046		1-
P 0023	WIRE ASSY				GRN 110 TMP/TMP	T9318060		2-
P 0024	WIRE ASSY				BLK 140 TMP/TMP	T9318047		1-
P 0024	WIRE ASSY				YEL 140 TMP/TMP	T9318061		2-
P 0025	WIRE ASSY				ORG 150 TMP/TMP	T9318048		1-
P 0025	WIRE ASSY				GRA 150 TMP/*	T9318065		2-
P 0026	WIRE ASSY				A1179	T9206715		1-
P 0027	WIRE ASSY				GRN 500 TMP/TMP	T9318049		1-
P 0028	WIRE ASSY				RED 290 TMP/TMP	T9311404		1-
P 0028	WIRE ASSY				RED 310 TMP/TMP	T9318058		2-
P 0028	WIRE ASSY				RED 290 TMP/TMP	T9311404		7-
P 0029	WIRE ASSY				A1179	T9206716		1-
P 0029	WIRE ASSY				A1179	T9206716A		5-
P 0029	WIRE ASSY				A1179	T9206716B		7-
P 0030	WIRE ASSY				A1179	T9206717		1-
P 0032	WIRE ASSY				A1179	T9206757		2-
S 0001	ROTARY ENCODER				RSM20-250	Q9000631		1-
S 0002	ROTARY SWITCH				SRGPVJ-E	N0190173		1-
SP0001	SPEAKER	8-ohm			VS-66Y 3W/8 OHM	M4090066		1-

## *Introduction and Precautions*

The following procedures cover adjustments that are not normally required once the transceiver has left the factory. However, if damage occurs and some parts subsequently are replaced, realignment may be required. If a sudden problem occurs during normal operation, it is likely due to component failure; realignment should not be done until after the faulty component has been replaced.

We recommend that servicing be performed by authorized Yaesu service technicians, who are experienced with the circuitry and fully equipped for repair and alignment. If a fault is suspected, contact the selling dealer for instructions regarding repair. Authorized Yaesu service technicians have the latest modification information, and realign all circuits and make compete performance checks to ensure compliance with the factory specifications after repairs.

Those who do undertake any of the following alignments are cautioned to proceed at their own risk. Problems caused by unauthorized attempts at realignment are not covered by the warranty policy. Also, Yaesu must reserve the right to change circuits and alignment procedures in the interest of improved performance, without notifying owners. Under no circumstances should any alignment be attempted unless the normal function and operation of the transceiver are clearly understood, the cause of the malfunction has been clearly pinpointed and any faulty components replaced, and the need for realignment determined to be absolutely necessary.

The following test equipment (and thorough familiarity with its correct use) is necessary for complete realignment. Correction of problems caused by misalignment resulting from unauthorized adjustments made with improper test equipment is not covered by warranty. Although most

steps do not require all of the equipment listed, the interaction of some adjustments may require that more complex adjustments be performed afterwards. Do not attempt to perform only a single step unless it is clearly isolated electrically from all other steps. Rather, have all test equipment ready before beginning, and follow all of the steps in a section in the order they are presented.

## *Required Test Equipment*

- Digital DC Voltmeter (high-Z, 1 M $\Omega$ /V)
- DC Ammeter
- RF Millivoltmeter
- AC Voltmeter
- RF Standard Signal Generator w/ calibrated output and dB scale, 0 dB $\mu$  = 0.5  $\mu$ V
- AF Signal Generator with calibrated output
- Frequency Counter
- Two 50- $\Omega$  Dummy Loads (150 ~ 250 watts)
- 150- $\Omega$  Dummy Load (150 watts)
- In-Line Wattmeter (150 ~ 250 watts, 50- $\Omega$ )
- Linear Detector
- RF Attenuator (150 watts, 40 dB) or sampling coupler
- Spectrum Analyzer good to at least 1 GHz

## *Alignment Preparation & Precautions*

A 50- $\Omega$  dummy load and in-line wattmeter must be connected to the antenna jack in all procedures that call for transmission, except where specified otherwise. Correct alignment is not possible with an antenna. Except where specified otherwise, the transceiver should be tuned to 14.2000 MHz, USB mode, and these controls set as indicated:

- **MOX, PROC/KEYER, MONI OFF**
- **MIC & RF PWR** fully CCW
- **ATT, RF AMP, AGC-F, NB OFF**
- **AF** as required
- **SQL** fully CCW
- **SHIFT** 12-o'clock

# Alignment

- LOW CUT fully CCW
- HIGH CUT, RF GAIN fully CW

The transceiver's Alignment Routine is required for some procedures. If an Alignment Routine cannot be selected, power may have to be switched off then back on to re-enable menu selection.

To begin, turn the transceiver off. Press the **UP**, **DWN** and **FAST** keys on the microphone together while turning the transceiver on again.

In the alignment procedure, each alignment parameter is selected by rotating the **SUB-TUNE** dial. The alignment is performed by pressing the **MCK/W** key while injecting a signal of the required frequency and level.

Pressing the **MENU** key after a setting is made stores the entry. To exit the alignment routine, press **POWER**. After performing the system alignment in its entirety, individual settings can be returned to and adjusted should the need arise.

Read each step to determine if the same test equipment used in the previous step will be required. If not, remove the test equipment (except dummy load and wattmeter, if connected) before proceeding. Correct alignment requires that the ambient temperature be the same as that of the transceiver and test equipment, and that this temperature be held constant within 20 ~ 30°C (68 ~ 86°F). If the transceiver is brought into the shop from hot or cold air, it should be allowed time for thermal equalization with the environment before alignment. Alignments must only be made with oscillator shields and circuit boards firmly affixed in place. Also, the test equipment must be thoroughly warmed up before beginning.

*Note: Signal levels in dB referred to in alignment are based on 0 dBμ = 0.5 μV.*

*Table Note: DC voltages should be within ±10 % of those listed in the voltage tables.*

## PLL Adjustments

### HF-VCO VCV adjustment

- Connect the DC voltmeter to TP2001, and referring to table below, tune the transceiver to each frequency, then confirm or adjust the listed component for the required voltage.

HF VCO Adjustment		
Tune to:	Adjust/Confirm	for
10.495 MHz	adjust T2001	6.5V±0.1V
0.100 MHz	confirm	at least 0.4V
21.995 MHz	adjust T2002	6.5V±0.1V
10.500 MHz	confirm	at least 0.4V
36.995 MHz	adjust T2003	6.5V±0.1V
22.000 MHz	confirm	at least 0.4V
53.995 MHz	adjust T2004	6.5V±0.1V
37.000 MHz	confirm	at least 0.4V
75.995 MHz	adjust T2005	6.5V±0.1V
54.000 MHz	confirm	at least 0.4V

### VHF-VCO VCV check

- Connect the DC voltmeter to TP2002, and referring to table below, tune the transceiver to each frequency, then confirm that the required voltage is present.

VHF VCO check	
Tune to:	for
108.000 MHz	at least 0.5V
139.995 MHz	less than 7.2V
140.000 MHz	at least 0.5V
173.995 MHz	less than 7.0V

### UHF-VCO VCV check

- Connect the DC voltmeter to TP2003, and referring to table below, tune the transceiver to each frequency. Confirm that the required voltage is present.

UHF VCO check	
Tune to:	for
420.000 MHz	at least 0.5V
459.995 MHz	less than 7.0V
460.000 MHz	at least 0.5V
511.000 MHz	less than 7.0V

## PA Unit Adjustments (HF)

### Pre-drive section Idling Current Adjustment

- Connect the 50-Ω dummy load to the **HF** antenna jack, and remove the jumper connector at J5006. Connect the ammeter to J5006 (pin 1 "+" lead, pin 2 "-" lead). Tune the transceiver to 14.005 MHz, and select the CW mode.
- Press the **MOX** switch, and without closing the "Key" line, adjust VR5001 for 0.25 A ( $\pm 0.025$  A) on the ammeter. Then remove the ammeter and reinstall the jumper connector at J5006.

### Drive section Idling Current Adjustment

- Connect the 50-Ω dummy load to the **HF** antenna jack, and remove the jumper connector at J5007. Connect the ammeter to J5007 (pin 1 "+" lead, pin 2 "-" lead). Tune the transceiver to 14.005 MHz, and select the CW mode.
- Press the **MOX** switch, and without closing the "Key" line, adjust VR5002 for 1.5 A ( $\pm 0.15$  A) on the ammeter. Then remove the ammeter and reinstall the jumper connector at J5007.

### Final section Idling Current Adjustment

- Connect the 50-Ω dummy load to the **HF** antenna jack, and remove the jumper between TP5001 and TP5002. Connect the ammeter between TP5001 ("+" lead) and TP5002 ("- lead). Tune the transceiver to 14.005 MHz, and select the CW mode.
- Press the **MOX** switch, and without closing the "Key" line, adjust VR5003 for 0.42 A ( $\pm 0.025$  A) on the ammeter. Then remove the ammeter and reinstall the jumper between TP5001 and TP5002.

### CM coupler balance

- Tune the transceiver to the 50 MHz high band edge (different in each country), and connect the 50-Ω dummy load to the **50MHz** antenna jack. Preset the **RF PWR** control fully clockwise and select the FM mode. Connect the DC volt-

meter between J5001's pin 1 and chassis ground.

- Key the transmitter, and with no microphone input, adjust TC5001 for minimum indication on the DC voltmeter.

## V/U-PA Unit Adjustments

### VHF-PA section Idling Current Adjustment

- Tune the transceiver to 145.995 MHz, and select the CW mode. Connect the 50-Ω dummy load to the **144MHz** antenna jack. Remove the jumper between TP4001 and TP4002, and connect the ammeter between TP4001 ("- lead) and TP4002 ("+" lead).
- Press the **MOX** switch, and without closing the Key line, adjust VR4002 for 0.3 A ( $\pm 0.03$  A) on the ammeter. Then remove the ammeter and reinstall the jumper between TP4001 and TP4002.

### UHF-PA section Idling Current Adjustment

- Tune the transceiver to 439.995 MHz, and select the CW mode. Connect the 50-Ω dummy load to the **430MHz** antenna jack. Remove the jumper between TP4003 and TP4004, and connect the ammeter between TP4003 ("- lead) and TP4004 ("+" lead).
- Press the **MOX** switch, and without closing the "Key" line, adjust VR4001 for 0.3 A ( $\pm 0.03$  A) on the ammeter. Then remove the ammeter and reinstall the jumper between TP4003 and TP4004.

## TX and RX IF Adjustments

### Reference Output Adjustment

- Connect the RF millivoltmeter to TP1002, and adjust T1010 and T1007 for maximum indication on the RF millivoltmeter.
- Replace the RF millivoltmeter with the frequency counter, and adjust TC1001 for 45.250 MHz ( $\pm 10$  Hz) on the frequency counter.
- Remove the coaxial plug from J1002 and connect the RF millivoltmeter across the socket

# Alignment

Adjust T1003 for maximum indication on the RF millivoltmeter.

- ❑ Remove the RF millivoltmeter, and replace the plug into J1002.

## *TX Local Adjustment*

- ❑ Connect the 50- $\Omega$  dummy load to the **HF** antenna jack and connect the DC voltmeter to TP1003. Select the CW mode.
- ❑ Key the transmitter, and adjust T1009 for 3.0 V ( $\pm 0.2$  V) on the DC voltmeter.

## *TX DDS Adjustment*

- ❑ Connect the RF millivoltmeter to TP1004, and adjust T1020 for maximum indication on the RF millivoltmeter.

## *RX DDS Adjustment*

- ❑ Connect the RF millivoltmeter to TP1005, and adjust T1021 for maximum indication on the RF millivoltmeter.

## *FM IF Adjustment*

- ❑ Connect the 50- $\Omega$  dummy load to the **HF** antenna jack and connect the RF millivoltmeter to TP1005. Select the FM mode.
- ❑ Key the transmitter, and adjust T1012 ~ T1014 for maximum indication on the RF millivoltmeter.
- ❑ Replace the RF millivoltmeter with the frequency counter. Key the transmitter, and adjust T1016 for 45.580 MHz ( $\pm 100$  Hz) on the frequency counter.

## *Carrier Frequency Adjustment*

- ❑ Remove the coaxial plug from J1003 and connect the frequency counter across the socket. Select the CW mode.
- ❑ Key the transmitter, and adjust TC1002 for 45.580 MHz ( $\pm 10$  Hz) on the frequency counter.
- ❑ Replace the frequency counter with the RF millivoltmeter, and key the transmitter, and adjust T1002 for maximum indication on the RF millivoltmeter.

- ❑ Remove the RF millivoltmeter, and replace the plug into J1002.

## *RX IF Sensitivity*

- ❑ Preset the RF control fully clockwise. Remove the coaxial plug from J1001 and connect the signal generator across the socket, and inject 0 dBm at 45.705 MHz (no modulation). Connect the DC voltmeter to TP1048.
- ❑ Adjust T1005, T1008, T1015, and T1017 ~ T1019 for minimum indication on the DC voltmeter.
- ❑ Remove the signal generator, and replace the plug into J1001.

## *Noise Blanker Adjustment*

- ❑ Remove the coaxial plug from J1001 and connect the signal generator across the socket, and connect the DC voltmeter to TP1049. Inject a signal at 45.705 MHz (no modulation) so as to get a reading on the DC voltmeter.
- ❑ Adjust T1004 and T1006 for minimum indication on the DC voltmeter. Increase the signal generator level, if necessary, to maintain a useful DC voltage indication.
- ❑ Remove the signal generator, and replace the plug into J1001.

## *TX and RX Adjustments*

### *VHF RX IF Sensitivity*

- ❑ Connect the signal generator to the **144MHz** antenna jack, and connect the SINAD meter and 4- $\Omega$  dummy load to the **EXT SPKR** jack. Tune the transceiver to 145.995 MHz, and select the FM mode. Preset the **RF** control fully clockwise and the **SQL** control fully counter-clockwise.
- ❑ Inject a signal from the signal generator at 145.995 MHz ( $\pm 3.5$  kHz deviation of a 1 kHz tone), adjust the level to get a moderate SINAD reading on the meter, and adjust T3006, T3012, T3014, T3017, T3027, T3029, and T3031 for optimum SINAD.

- Connect the DC voltmeter to TP1048 and chassis ground, and select the CW mode.
- Inject a signal at 145.995 MHz so as to get a reading on the DC voltmeter, and adjust T3006, T3012, T3014, T3017, and T3031 for minimum indication on the DC voltmeter.
- Now inject a signal at 129.995 MHz, and tune the transceiver to 129.995 MHz. Adjust T3007, T3011, T3015, and T3018 for minimum indication on the DC voltmeter.

### 50 MHz RX IF Sensitivity

- Connect the signal generator to the **50MHz** antenna jack, and connect the DC voltmeter between TP1048 and chassis ground. Tune the transceiver to 50.295 MHz, and select the CW mode. Preset the **RF** control fully clockwise and the **SQL** control fully counter-clockwise.
- Inject a signal at 50.295 MHz so as to get deflection on the DC voltmeter, and adjust T3019, T3021, T3025, and T3028 for minimum indication on the DC voltmeter.

### 144 MHz TX Adjustment

- With the inline wattmeter and 50- $\Omega$  dummy load connected to the **144MHz** antenna jack, connect the AF generator to the **MIC** jack (pin 8: mic input, pin 7: ground). Tune the transceiver to 145.995 MHz, and select the USB mode.
- Inject a 1 kHz tone at 3 mV level to the **MIC** jack. Key the transmitter, and adjust T1002 on the AF-CNTL Unit and T3005, T3008, and T3010 on the RF Unit in succession several times for maximum indication on the inline wattmeter.
- Select the FM mode. Key the transmitter, and adjust TC4002 for maximum indication on the inline wattmeter.
- Connect the DC voltmeter between pin 3 of J4007 and chassis ground. Key the transmitter, and adjust VR4004 for minimum indication on the DC voltmeter.

- Select the FM mode. Key the transmitter, and adjust VR3003 for 50 W on the inline wattmeter.

### 430 MHz TX Adjustment

- With the inline wattmeter and 50- $\Omega$  dummy load connected to the **430MHz** antenna jack, connect the AF generator to the **MIC** jack (pin 8: mic input, pin 7: ground). Tune the transceiver to 439.995 MHz, and select the USB mode.
- Inject a 1 kHz tone at 3 mV level to the **MIC** jack. Key the transmitter, and adjust TC3001, TC3003, and TC3004 in succession several times for maximum indication on the inline wattmeter.
- Select the FM mode. Key the transmitter, and adjust TC4001, TC4003, and TC4005 in succession several times for maximum indication on the inline wattmeter.
- Connect the DC voltmeter between pin 3 of J4007 and chassis ground.
- Key the transmitter, and adjust TC4004 for minimum indication on the DC voltmeter.
- Still in the FM mode, key the transmitter, and adjust VR3002 for 50 W on the inline wattmeter.

### 50 MHz TX Adjustment

- With the inline wattmeter and 50- $\Omega$  dummy load connected to the **50MHz** antenna jack, connect the AF generator to the **MIC** jack. Tune the transceiver to 50.295 MHz, and select the USB mode.
- Inject a signal from the AF generator at 1 kHz tone. Key the transmitter, adjust the audio level so as to produce power output that can be read on the external wattmeter, and then adjust T3003, T3009, T3013, and T3016 in succession several times for maximum indication on the external wattmeter.
- Tune the transceiver to 50.295 MHz (for French version) or 51.995 MHz (for other versions), and select the FM mode. Key the transmitter, and adjust VR3004 for 100 W on the external wattmeter.

# Alignment

## *HF TX Adjustment*

- With the inline wattmeter and 50- $\Omega$  dummy load connected to the **HF** antenna jack, tune the transceiver to 3.505 MHz, and select the FM mode.
- Key the transmitter, and adjust VR3006 for 100 W on the inline wattmeter.
- Tune the transceiver to 1.830 MHz, and select the FM mode. Key the transmitter, and adjust VR3005 for 100 W on the inline wattmeter.

## *AFP adjustment*

- Preset VR3007, VR3008, and VR3009 fully clockwise, and connect the ammeter between the transceiver's **13.8VDC** connector and the DC power supply.
- Tune the transceiver to 145.995 MHz and select the CW mode (with no connection to the **144MHz** antenna jack). Key the transmitter, and adjust VR1001 for 8.0 A ( $\pm 0.1$  A) on the ammeter.
- Tune the transceiver to 439.995 MHz and select the CW mode (with no connection to the **430MHz** antenna jack). Key the transmitter, and confirm the current on the ammeter. If over 8.0 A on the ammeter, adjust VR1001 for 8.0 A ( $\pm 0.1$  A) on the ammeter. If under 8.0 A on the ammeter, adjust VR3007 for 8.0 A ( $\pm 0.1$  A) on the ammeter.
- Connect the 50- $\Omega$  dummy load to the **HF** antenna jack. Tune the transceiver to 14.005 MHz and select the CW mode. Key the transmitter, and make a note of the current on the ammeter.
- Disconnect the 50- $\Omega$  dummy load and connect the 150- $\Omega$  dummy load (or three 50- $\Omega$  loads in parallel) to the **HF** antenna jack. Key the transmitter, and compare the current with the above step. If the ammeter reading is more than 4.0 A lower than that measured in the previous step, adjust VR1001 for 4.0 A ( $\pm 0.2$  A) lower than the previous step. If the ammeter read-

ing is less than 4.0 A below that measured in the previous step, adjust VR3009 for a reading 4.0 A ( $\pm 0.2$  A) lower than that of the previous step.

## *TX and RX Adjustments*

### *(Alignment Menu Adjustments)*

#### *144 MHz Band FM-S1 Adjustment*

- Connect the signal generator to the **144MHz** antenna jack, and tune the transceiver to 145.995 MHz. Select the FM mode.
- Select alignment menu [FM-S1], and inject a  $-6$  dB $\mu$  signal ( $\pm 3.5$  kHz deviation of a 1 kHz tone). Then press the **MCK/W** key.

#### *144 MHz Band FM-Full Scale Adjustment*

- Connect the signal generator to the **144MHz** antenna jack, and tune the transceiver to 145.995 MHz. Select the FM mode.
- Select alignment menu [FM-FULL], and inject a  $+20.0$  dB $\mu$  signal ( $\pm 3.5$  kHz deviation of a 1 kHz tone). Then press the **MCK/W** key.

#### *144 MHz Band Scan Discriminator*

##### *Center-Stop Adjustment*

- Connect the signal generator to the **144MHz** antenna jack, and tune the transceiver to 145.995 MHz. Select the FM mode.
- Select alignment menu [DISC-L], and inject a signal at 145.992 MHz, level  $+20.0$  dB $\mu$  ( $\pm 3.5$  kHz deviation of a 1 kHz tone). Then press the **MCK/W** key.
- Select alignment menu [DISC-H], and inject a signal at 145.998 MHz, level  $+20.0$  dB $\mu$  ( $\pm 3.5$  kHz deviation of a 1 kHz tone). Then press the **MCK/W** key.

#### *144 MHz Band SQL Threshold Adjustment*

- Tune the transceiver to 145.995 MHz, and the select the FM mode.
- Select alignment menu [SQL-TH-L], and inject no RF input. Then press the **MCK/W** key.
- Press the **A>B** key ([SQL-TH-H] will appear

on the display), and apply no RF input. Then press the **MCK/W** key.

## *144 MHz Band SQL Tight Adjustment*

- Connect the signal generator to the **144MHz** antenna jack, and tune the transceiver to 145.995 MHz. Select the FM mode.
- Select alignment menu [SQL-TI-L], and inject a signal at 145.995 MHz, level 0 dB $\mu$  ( $\pm 3.5$  kHz deviation of a 1 kHz tone). Then press the **MCK/W** key.
- Press the **A>B** key ([SQL-TI-H] display), and inject a signal at 145.995 MHz, level 0 dB $\mu$  ( $\pm 3.5$  kHz deviation of a 1 kHz tone). Then press the **MCK/W** key.

## *144 MHz Band SSB-S1 Adjustment*

- Select alignment menu [SSB-S1], and tune the transceiver to 145.995 MHz. Select the USB mode, preset the **RF** control to the 2-o'clock position, and inject no RF input. Then press the **MCK/W** key.

## *144 MHz Band SSB-S9 Adjustment*

- Connect the signal generator to the **144MHz** antenna jack, and tune the transceiver to 145.995 MHz.
- Select alignment menu [SSB-S9], select the USB mode, and preset the **RF** control fully clockwise. Inject a signal of level +25 dB $\mu$  (no modulation), then press the **MCK/W** key.

## *144 MHz Band SSB-Full Scale Adjustment*

- Connect the signal generator to the **144MHz** antenna jack, and tune the transceiver to 145.995 MHz. Select alignment menu [SSB-FULL], and inject a signal of level +85 dB $\mu$  (no modulation). Then press the **MCK/W** key.

## *144 MHz Band RX Gain Adjustment*

- Connect the signal generator to the **144MHz** antenna jack, and tune the transceiver to 145.995 MHz.

- Select alignment menu [RX-GAIN], and select the USB mode. Inject a signal of level -6 dB $\mu$  (no modulation), and adjust the **MEM/VFO CH** control for just 1 segment indication on the S-meter. Then press the **MCK/W** key.

## *430 MHz Band RX Gain Adjustment*

- Connect the signal generator to the **430MHz** antenna jack, and tune the transceiver to 439.995 MHz.
- Select alignment menu [RX-GAIN], and select the USB mode. Inject a signal of level -6 dB $\mu$  (no modulation), and adjust the **MEM/VFO CH** control for just 1 segment indication on the S-meter. If the hexadecimal data on the transceiver's display is less than "40H", turn the **MEM/VFO CH** control for just "40H" indication on the display. Then press the **MCK/W** key.

## *50 MHz Band RX Gain Adjustment*

- Connect the signal generator to the **50MHz** antenna jack, and tune the transceiver to 51.995 MHz (for vers. A, C, D, H) or 50.295 MHz (for vers. B, E).
- Select alignment menu [RX-GAIN], and select the CW mode. Inject a signal of level -3 dB $\mu$  (no modulation), and adjust the **MEM/VFO CH** control for just 1 segment indication on the S-meter. Then press the **MCK/W** key.

## *HF Band RX Gain Adjustment*

- Connect the signal generator to the **HF** antenna jack, and tune the transceiver and RF signal generator to 28.995 MHz.
- Select alignment menu [RX-GAIN], and select the USB mode. Inject a signal of level 0 dB $\mu$  (no modulation), and adjust the **MEM/VFO CH** control for just 1 segment indication on the S-meter. Then press the **MCK/W** key.
- Tune the transceiver and RF signal generator to 14.005 MHz, and select the USB mode. Inject a signal of level 0 dB $\mu$  (no modulation),



# Alignment

and adjust the **MEM/VFO CH** control for just 1 segment indication on the S-meter. Then press the **MCK/W** key.

- Tune the transceiver and RF signal generator to 3.505 MHz, and select the USB mode. Inject a signal of level +3 dB $\mu$  (no modulation), and adjust the **MEM/VFO CH** control for just 1 segment indication on the S-meter. Then press the **MCK/W** key.

## *SHIFT Control Center Preset*

- Preset the **SHIFT** control to the 12-o'clock position. Select alignment menu [SFT-CTR], and press the **MCK/W** key. *After this preset procedure, do not turn the **SHIFT** control. If you accidentally turn it, repeat the above procedure for pre-setting the **SHIFT** control.*

## *RX SSB Carrier Point Adjustment*

- Tune the transceiver to 145.995 MHz. Select alignment menu [RXC-PNT], and inject no RF input.
- Adjust the **MEM/VFO CH** control for identical "sound" of the noise from the speaker while switching between USB and LSB. Then press the **MCK/W** key.

## *TX SSB Carrier Point Adjustment*

- Connect the 50- $\Omega$  dummy load to the **144MHz** antenna jack, and connect the ammeter between the transceiver's **13.8VDC** connector and DC power supply. Tune the transceiver to 145.995 MHz, and select alignment menu [TXC-USB].
- Set "regular" Menu #92 and #93 to "0" if they are not already set to that value.
- Key the transmitter, and adjust the **MEM/VFO CH** control for minimum indication on the ammeter.
- Select alignment menu [TXC-LSB]. Key the transmitter, and adjust the **MEM/VFO CH** control for minimum indication on the ammeter.

## *HF Band PO Meter Adjustment*

- Connect the 50- $\Omega$  dummy load to the **HF** antenna jack. Tune the transceiver to 14.005 MHz, and select the FM mode.
- Select alignment menu [PWR-100]. Key the transmitter, and adjust the **RF PWR** control for 100 W indication on the external wattmeter. Then press the **MCK/W** key.
- Select alignment menu [PWR-50]. Key the transmitter, and adjust the **RF PWR** control for 50 W indication on the external wattmeter. Then press the **MCK/W** key.
- Select alignment menu [PWR-20]. Key the transmitter, and adjust the **RF PWR** control for 20 W indication on the external wattmeter. Then press the **MCK/W** key.
- Select alignment menu [PWR-10]. Key the transmitter, and adjust **RF PWR** control for 10 W indication on the external wattmeter. Then press the **MCK/W** key.

## *1.9 MHz Band PO Meter Adjustment*

- Connect the 50- $\Omega$  dummy load to the **HF** antenna jack. Tune the transceiver to 1.910 MHz (for vers. A, H), 1.850 MHz (for vers. B, C, D) or 1.840 MHz (for vers. E), and select the CW mode.
- Select alignment menu [PWR-100]. Key the transmitter, and adjust the **RF PWR** control for 100 W indication on the external wattmeter. Then press the **MCK/W** key.
- Select alignment menu [PWR-50]. Key the transmitter, and adjust the **RF PWR** control for 50 W indication on the external wattmeter. Then press the **MCK/W** key.
- Select alignment menu [PWR-20]. Key the transmitter, and adjust the **RF PWR** control for 20 W indication on the external wattmeter. Then press the **MCK/W** key.
- Select alignment menu [PWR-10]. Key the transmitter, and adjust the **RF PWR** control

for 10 W indication on the external wattmeter. Then press the **MCK/W** key.

## *50 MHz Band PO Meter Adjustment*

- Connect the 50- $\Omega$  dummy load to the **50MHz** antenna jack. Tune the transceiver to 51.995 MHz (for vers. A, C, D, H) or 50.295 MHz (for vers. B, E), and select the CW mode.
- Select alignment menu [PWR-100]. Key the transmitter, and adjust the **RF PWR** control for 100 W indication on the external wattmeter. Then press **MCK/W** key.
- Select alignment menu [PWR-50]. Key the transmitter, and adjust the **RF PWR** control for 50 W indication on the external wattmeter. Then press the **MCK/W** key.
- Select alignment menu [PWR-20]. Key the transmitter, and adjust the **RF PWR** control for 20 W indication on the external wattmeter. Then press the **MCK/W** key.
- Select alignment menu [PWR-10]. Key the transmitter, and adjust the **RF PWR** control for 10 W indication on the external wattmeter. Then press the **MCK/W** key.

## *144/430 MHz Band PO Meter Adjustment*

- Connect the 50- $\Omega$  dummy load to the **144MHz** antenna jack. Tune the transceiver to 145.995 MHz, and select the FM mode.
- Select alignment menu [PWR-100]. Rotate the **MEM/VFO CH** control to select the (hexadecimal data) value of "FF".
- Select alignment menu [PWR-50]. Key the transmitter, and adjust the **RF PWR** control for 50 W indication on the external wattmeter. Then press the **MCK/W** key.
- Select alignment menu [PWR-20]. Key the transmitter, and adjust the **RF PWR** control for 20 W indication on the external wattmeter. Then press the **MCK/W** key.
- Select alignment menu [PWR-10]. Key the transmitter, and adjust the **RF PWR** control

for 10 W indication on the external wattmeter. Then press the **MCK/W** key.

## *ALC Meter Adjustment*

- With the inline wattmeter and 50- $\Omega$  dummy load connected to the **144MHz** antenna jack, connect the AF generator to the **MIC** jack. Tune the transceiver to 145.005 MHz, and select the USB mode.
- Select alignment menu [ALC-1] and inject no microphone input. Key the transmitter, then press the **MCK/W** key. Now adjust the **MEM/VFO CH** control for a (hexadecimal data) "+4" indication on the display.
- Select alignment menu [ALC-9] and inject a 1 kHz tone signal of level 3 mV to the **MIC** jack. Key the transmitter, and adjust the **MIC** control for just 1 segment indication on the ALC meter.
- Without touching the setting of the **MIC** control, inject a 1 kHz tone at 10 mV to the **MIC** jack. Then press the **MCK/W** key.

## *144 MHz Band TX Adjustment*

- With the inline wattmeter and 50- $\Omega$  dummy load connected to the **144MHz** antenna jack, connect the AF generator to the **MIC** jack (pin 8: mic input, pin 7: ground). Tune the transceiver to 145.995 MHz, and select the USB mode. Preset the **MIC** control to the 1-o'clock position.
- Select alignment menu [TX-GAIN] and inject a 1 kHz tone at 1 mV level to the **MIC** jack. Key the transmitter, and adjust the **MEM/VFO CH** control for 25 W on the external wattmeter. If the hexadecimal data on the transceiver's display is less than "8FH", turn the **MEM/VFO CH** control for just "8FH" indication on the display.

## *430 MHz Band TX Adjustment*

- With the inline wattmeter and 50- $\Omega$  dummy load connected to the **430MHz** antenna jack,

# Alignment

connect the AF generator to the **MIC** jack (pin 8: mic input, pin 7: ground). Tune the transceiver to 439.995 MHz, and select the USB mode. Preset the **MIC** control to the 1-o'clock position.

- Select alignment menu [TX-GAIN] and inject a 1 kHz tone at 1 mV level to the **MIC** jack. Key the transmitter, and adjust the **MEM/VFO CH** control for 25 W on the external wattmeter. If the hexadecimal data on the transceiver's display is less than "8FH", turn the **MEM/VFO CH** control for just "8FH" indication on the display.

## 50 MHz Band TX Adjustment

- With the inline wattmeter and 50- $\Omega$  dummy load connected to the **50MHz** antenna jack, connect the AF generator to the **MIC** jack (pin 8: mic input, pin 7: ground). Tune the transceiver to 51.995 MHz (for vers. A, C, D, H) or 50.295 MHz (for vers. B, E), and select the USB mode. Preset the **MIC** control to the 1-o'clock position.
- Select alignment menu [TX-GAIN] and inject a 1 kHz tone at 1 mV level to the **MIC** jack. Key the transmitter, and adjust the **MEM/VFO CH** control for 50 W on the external wattmeter. If the hexadecimal data on the transceiver's display is less than "8FH", turn the **MEM/VFO CH** control for just "8FH" indication on the display.

## HF Band TX Adjustment

- With the inline wattmeter and 50- $\Omega$  dummy load connected to the **HF** antenna jack, connect the AF generator to the **MIC** jack (pin 8: mic input, pin 7: ground). Select alignment menu [TX-GAIN], and select the USB mode. Preset the **MIC** control to the 1-o'clock position.
- Tune the transceiver to 28.995 MHz and inject a 1 kHz tone at 1 mV level to the **MIC** jack. Key the transmitter, and adjust the **MEM/VFO CH** control for 50 W on the inline wattmeter. If the

hexadecimal data on the transceiver's display is less than "8FH", turn the **MEM/VFO CH** control for just "8FH" indication on the display.

- Tune the transceiver to 14.005 MHz and inject 1 mV at 1 kHz tone to the **MIC** jack. Key the transmitter, and adjust the **MEM/VFO CH** control for 50 W on the inline wattmeter. If the hexadecimal data on the transceiver's display is less than "8FH", turn the **MEM/VFO CH** control for just "8FH" indication on the display.
- Tune the transceiver to 1.910 MHz (for vers. A, H), 1.850 MHz (for vers. B, C, D) or 1.840 MHz (for vers. E), and inject 1 mV at 1 kHz tone to the **MIC** jack. Key the transmitter, and adjust the **MEM/VFO CH** control for 50 W on the inline wattmeter. If the hexadecimal data on the transceiver's display is less than "8FH", turn the **MEM/VFO CH** control for just "8FH" indication on the display.

## SWR Meter Adjustment

- With the inline wattmeter and 50- $\Omega$  dummy load connected to the **HF** antenna jack, select the CW mode. Tune the transceiver to 14.005 MHz. Select alignment menu [SWR 1.5].
- Key the transmitter, and adjust the **RF PWR** control for 10 W on the external wattmeter.
- Replace the 50- $\Omega$  dummy load with a 100- $\Omega$  dummy load (two 50- $\Omega$  loads in parallel) connected to the **HF** antenna jack.
- Key the transmitter, and press the **MCK/W** key.
- Replace the 100- $\Omega$  dummy load with the 50- $\Omega$  dummy load connected to the **HF** antenna jack, and select alignment menu [SWR 3.0].
- Key the transmitter, and adjust the **RF PWR** control for 50 W on the inline wattmeter.
- Replace the 50- $\Omega$  dummy load with the 150- $\Omega$  dummy load (or three 50- $\Omega$ s in parallel) to the **HF** antenna jack.
- Key the transmitter, and press the **MCK/W** key.

## *FM Deviation Adjustment*

- With the 50 dB attenuator (or 50- $\Omega$  dummy load and sampling coupler) and linear detector connected to the **144MHz** antenna jack, connect the AF generator to the **MIC** jack (pin 8: mic input, pin 7: ground). Tune the transceiver to 145.995 MHz, and select the FM mode.
- Inject a 1 kHz tone at 15 mV level. Key the transmitter, and adjust VR1004 for  $\pm 4.5$  kHz deviation on the linear detector.
- Select the 88.5 Hz (default) subaudible tone, and activate CTCSS Encode operation. Key the transmitter, and adjust VR1003 for  $\pm 0.7$  kHz deviation on the linear detector.

## *Speech Processor Adjustment*

- With the inline wattmeter and 50- $\Omega$  dummy load connected to the **144MHz** antenna jack, connect the AF generator to the **MIC** jack (pin 8: mic input, pin 7: ground). Tune the transceiver to 145.995 MHz, select the USB mode, and leave the **PROC** switch off for now.
- Inject a 1 kHz tone at 1 mV level. Key the transmitter, and adjust the **MIC** control for 12.5 W on the wattmeter.
- Switch **PROC** on, key the transmitter, and adjust VR1002 for 25 W on the wattmeter.

## *Carrier Level Adjustment*

- Connect the 50- $\Omega$  dummy load to the **HF** antenna jack. Tune the transceiver to 1.910 MHz (for vers. A, H), 1.850 MHz (for vers. B, C, D) or 1.840 MHz (for vers. E), select the CW mode, and set **PROC** off. Select the TX meter to read ALC. Preset VR1006 fully clockwise.
- Connect the AF generator to the **MIC** jack (pin 8: mic input, pin 7: ground). Select the AM

mode, and inject a 1 kHz tone at 1 mV level to the **MIC** jack. Key the transmitter, and adjust VR1005 for at least a 5-segment indication on the ALC meter.

## *Carrier Balance Adjustment*

- Connect the RF attenuator (or 50- $\Omega$  dummy load and sampling coupler) and spectrum analyzer to the **144MHz** antenna jack. Tune the transceiver to 145.995 MHz, select the USB mode, and inject no microphone input.
- Key the transmitter, and adjust VR1007 for minimum carrier leakage (should be at least 45 dB below a carrier transmitted on the same frequency) as indicated on the analyzer.
- Select the LSB mode, and again inject no microphone input. Key the transmitter, and confirm that the carrier leakage is at least 45 dB down, as indicated on the analyzer.

## *50 MHz band Power Re-adjustment (for French version)*

- With the inline wattmeter and 50- $\Omega$  dummy load connected to the **50MHz** antenna jack, tune the transceiver to 50.295 MHz, and select the FM mode.
- Key the transmitter, and adjust VR3004 for 10 W on the inline wattmeter.

## *1.9 MHz band Power Re-adjustment (for Belgian version)*

- With the inline wattmeter and 50- $\Omega$  dummy load connected to the **HF** antenna jack, tune the transceiver to 1.850 MHz, and select the FM mode.
- Key the transmitter, and adjust VR3005 for 10 W on the inline wattmeter.

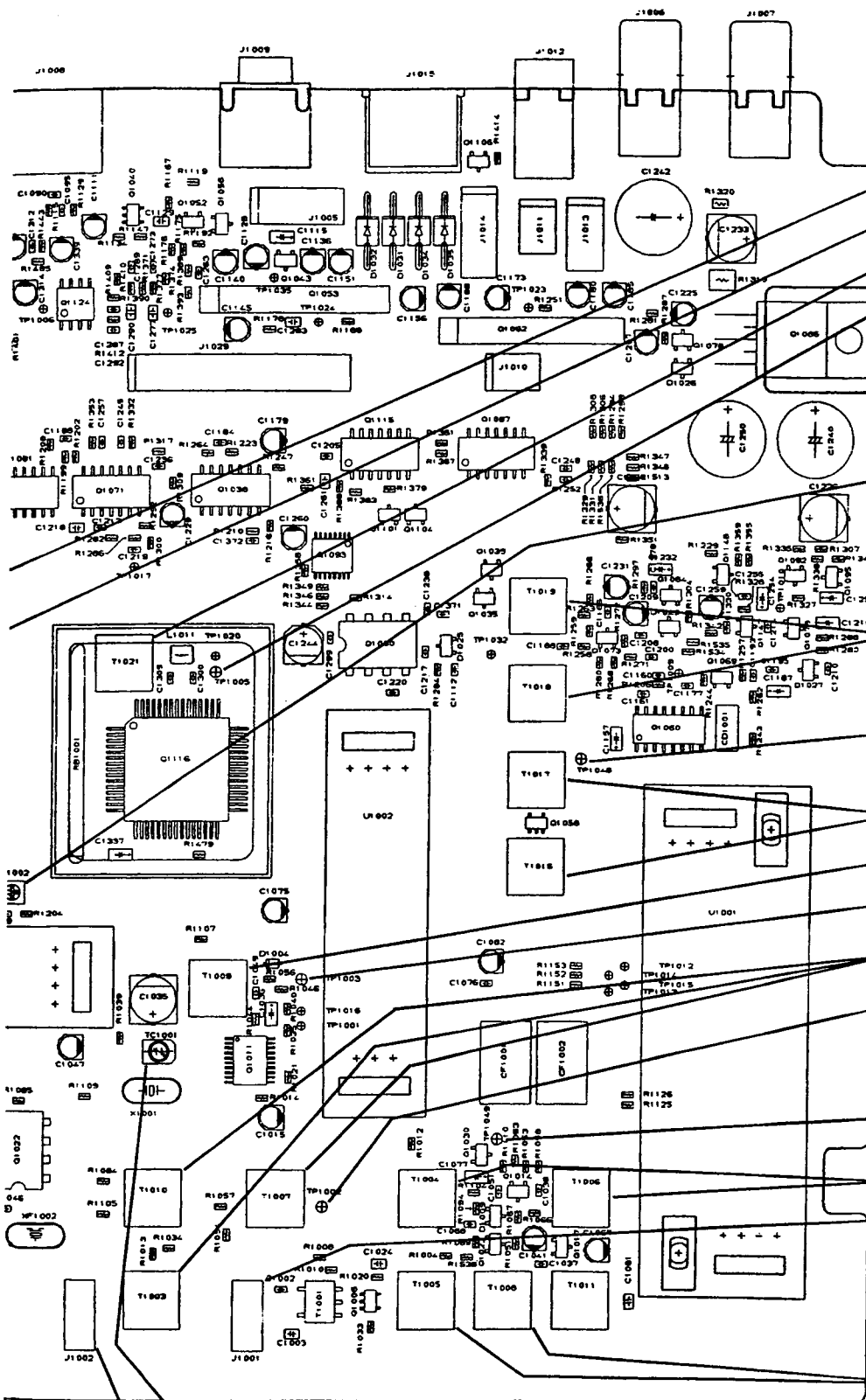

- T1020 TX DDS Adjust
- TP1004 TX DDS Adjust: RF Millivoltmeter (max.)
- T1021 RX DDS Adjust
- TP1005 RX DDS Adjust: RF Millivoltmeter (max.)
- VR1002 Carrier Frequency Adjust
- T1018, 09 RX IF Sensitivity
- TP1048 50 MHz RX IF Sensitivity: DC Voltmeter (min.)  
RX IF Sensitivity: DC Voltmeter (min.)
- T1015, 17 RX IF Sensitivity
- T1009 TX Local Adjust
- TP1003 TX Local Adjust: DC Voltmeter (3.0 V ± 0.2 V)
- T1003, 07, 10 Reference Output Adjust
- TP1002 Reference Output Adjust  
: DC Voltmeter (minimum indication)  
: Frequency Counter (45.250 MHz ± 10 Hz)
- TP1049 Noise Blanker Adjust: DC Voltmeter (min.)
- T1004, 06 Noise Blanker Adjust
- J1001 RX IF Sensitivity: Signal Generator  
Noise Blanker Adjust: Signal Generator
- T1005, 08 RX IF Sensitivity

- TC1001 Reference Output Adjust
- J1002 Reference Output Adjust: RF millivoltmeter (max.)
- T1002 Carrier Frequency Adjust
- 0 FM IF Adjust: RF millivoltmeter (max.)  
: Freq. Counter (45.580 MHz ± 100 Hz)
- Frequency Adjust: Freq. Counter (45.580 MHz ± 100 Hz)  
: RF millivoltmeter (max.)

# AF-CNTL Unit Alignment Points

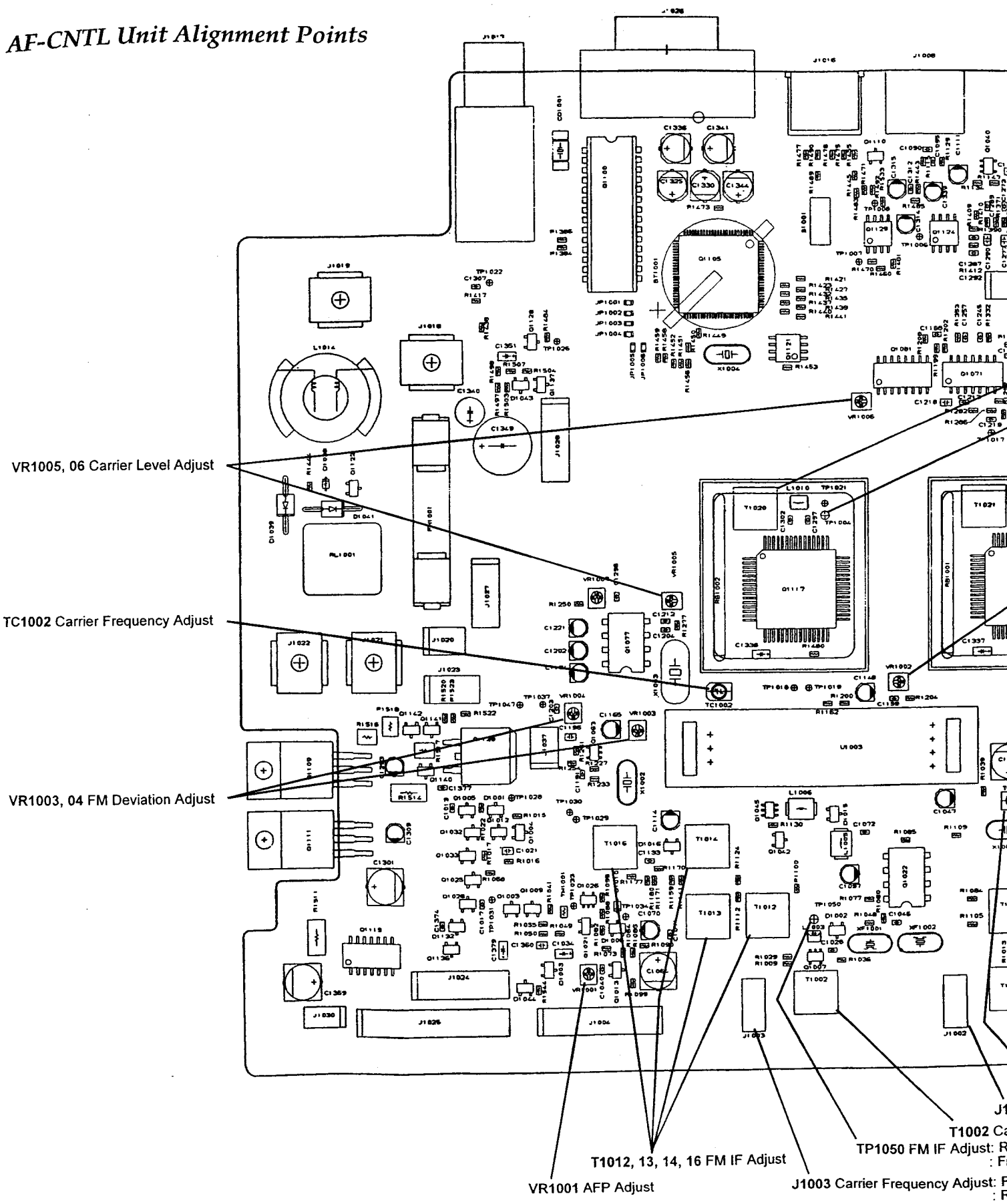

VR1005, 06 Carrier Level Adjust

TC1002 Carrier Frequency Adjust

VR1003, 04 FM Deviation Adjust

T1012, 13, 14, 16 FM IF Adjust

VR1001 AFP Adjust

J1003 Carrier Frequency Adjust

T1002 C  
TP1050 FM IF Adjust: R  
: F  
: F

# Alignment

## PLL Unit Alignment Points

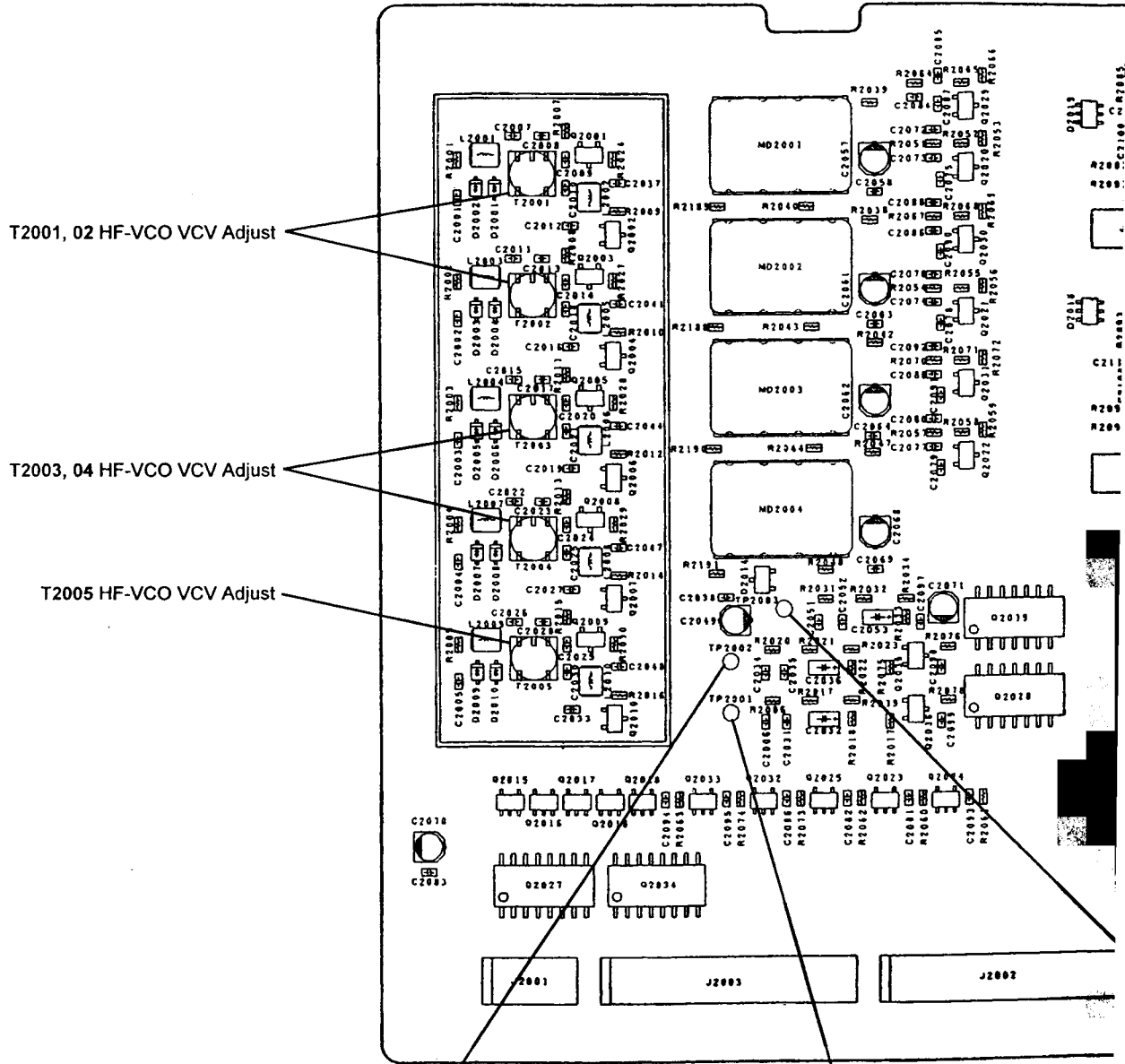

TP2001 HF-VCO VCV Adjust: DC V  
 TP2002 VHF-VCO VCV Check: DC Voltmeter

VHF VCO check	
Tune to:	for
108.000 MHz	at least 0.5V
139.995 MHz	less than 7.2V
140.000 MHz	at least 0.5V
173.995 MHz	less than 7.0V

HF VCO Adjustment		
Tune to:	Adjust/Confirm	
10.495 MHz	adjust T2001	6.5
0.100 MHz	confirm	at l
21.995 MHz	adjust T2002	6.5
10.500 MHz	confirm	at l
36.995 MHz	adjust T2003	6.5
22.000 MHz	confirm	at l
53.995 MHz	adjust T2004	6.5
37.000 MHz	confirm	at l
75.995 MHz	adjust T2005	6.5
54.000 MHz	confirm	at l

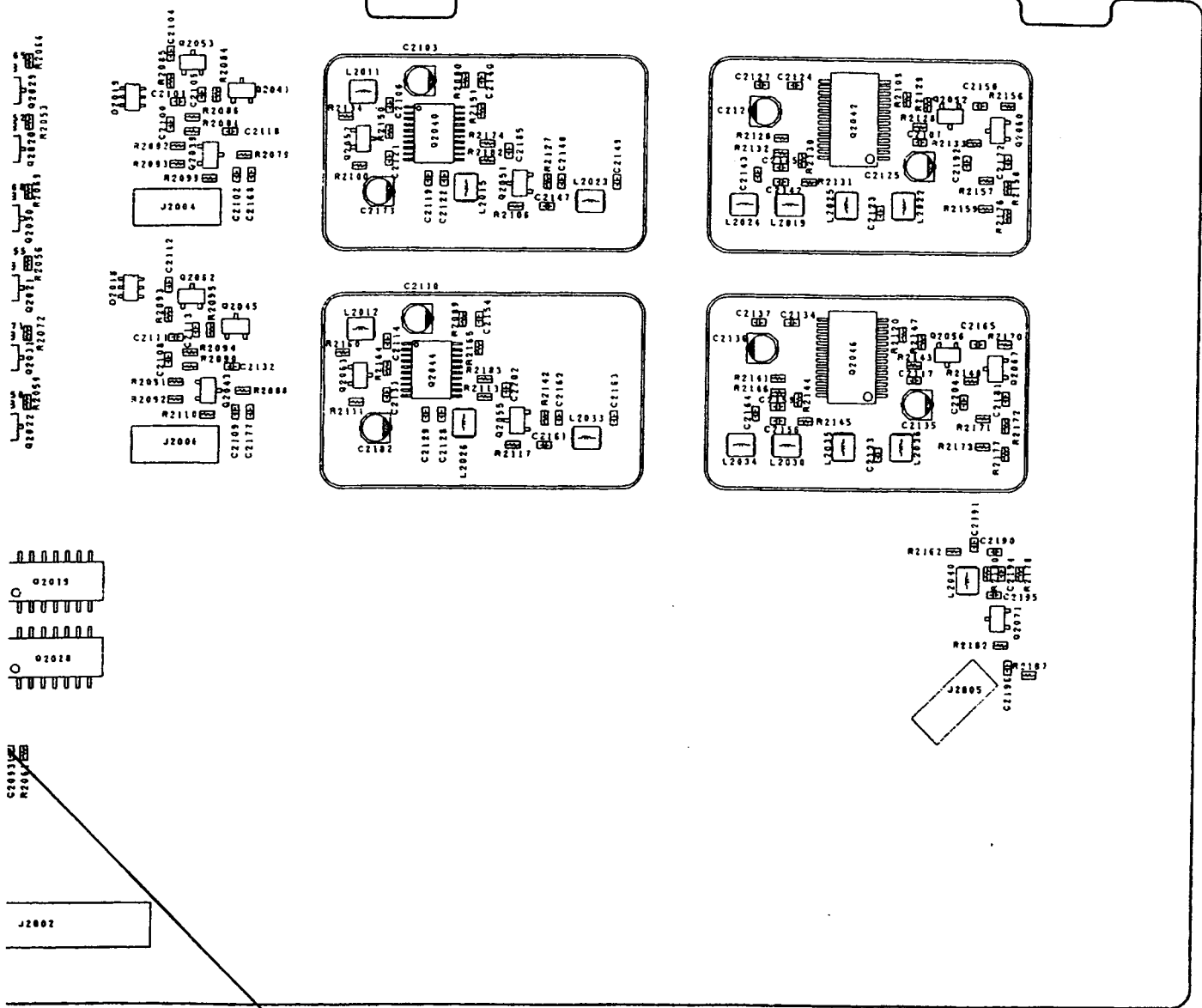

VCV Adjust: DC Voltmeter

TP2003 UHF-VCO VCV Check: DC Voltmeter

Adjustment

Test Point	Adjustment Value	Requirement
ust T2001	6.5V±0.1V	for
ifirm		at least 0.4V
ust T2002	6.5V±0.1V	for
ifirm		at least 0.4V
ust T2003	6.5V±0.1V	for
ifirm		at least 0.4V
ust T2004	6.5V±0.1V	for
ifirm		at least 0.4V
ust T2005	6.5V±0.1V	for
ifirm		at least 0.4V

UHF VCO check

Tune to:	for
420.000 MHz	at least 0.5V
459.995 MHz	less than 7.0V
460.000 MHz	at least 0.5V
511.000 MHz	less than 7.0V





# RF Unit Alignment Points

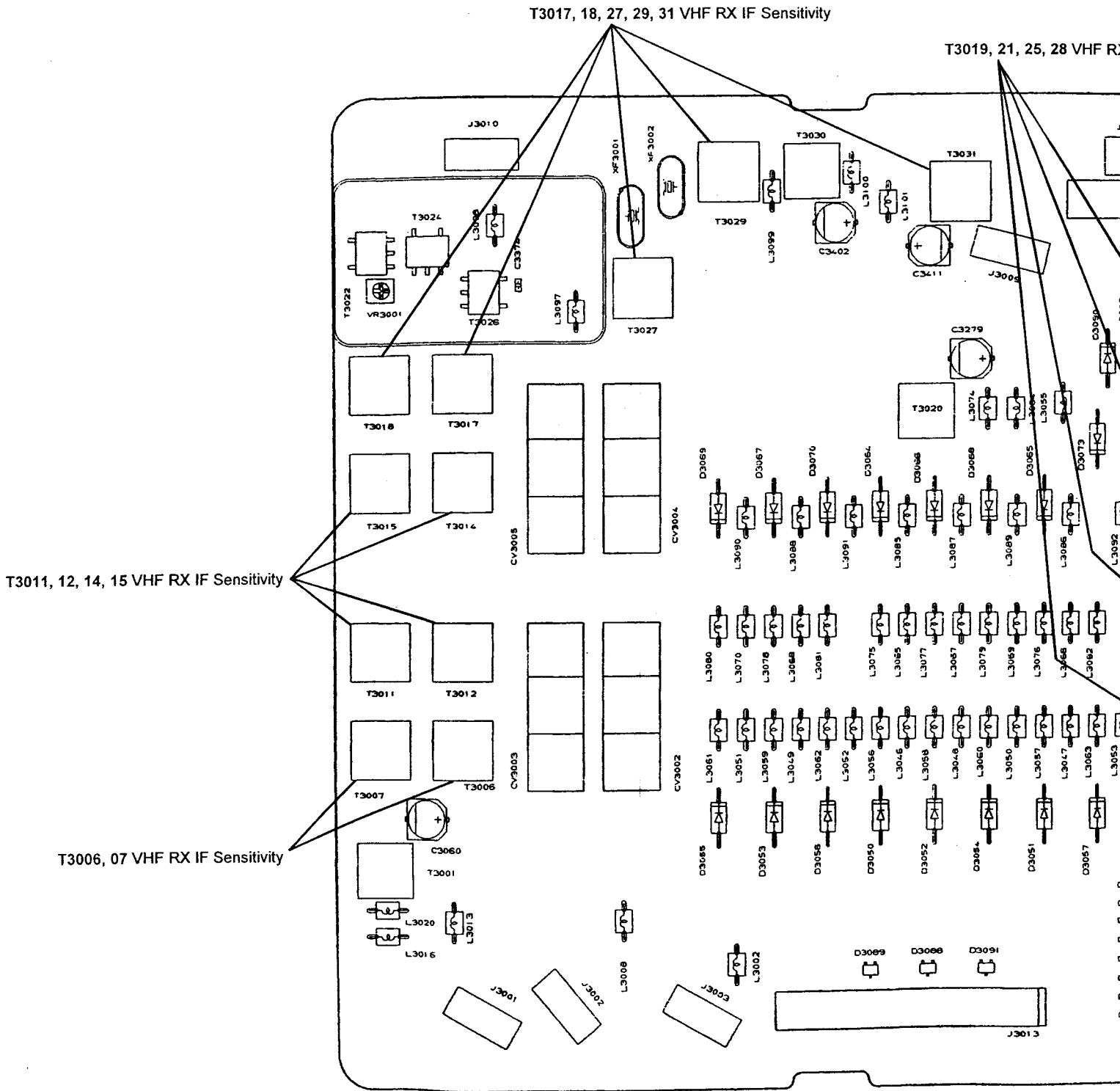

### V/U-PA Unit Alignment Points

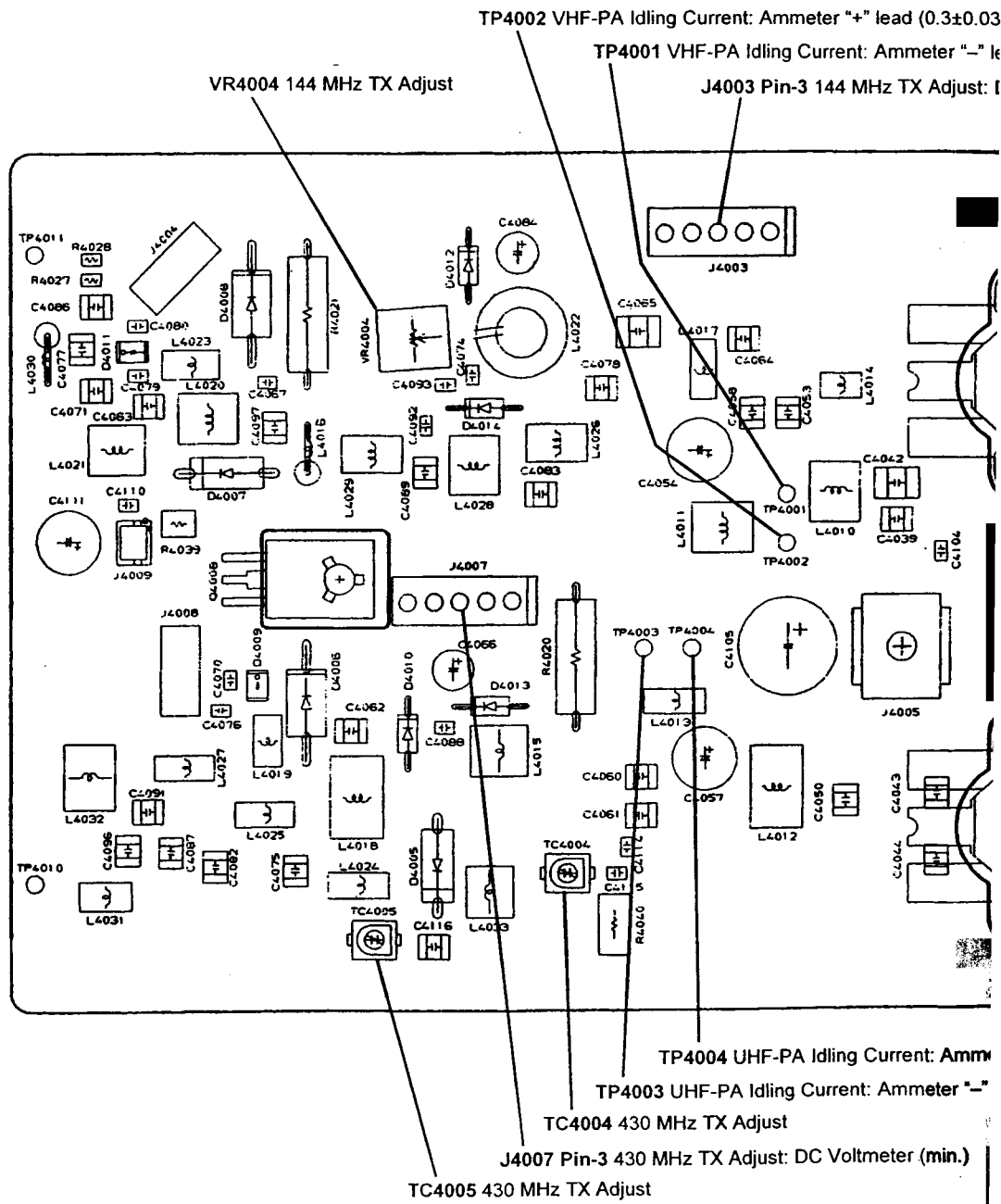

Ammeter "+" lead ( $0.3 \pm 0.03A$ )

ling Current: Ammeter "-" lead ( $0.3 \pm 0.03A$ )

Pin-3 144 MHz TX Adjust: DC Voltmeter (min.)

TC4002 144 MHz TX Adjust

VR4002 VHF-PA Idling Current

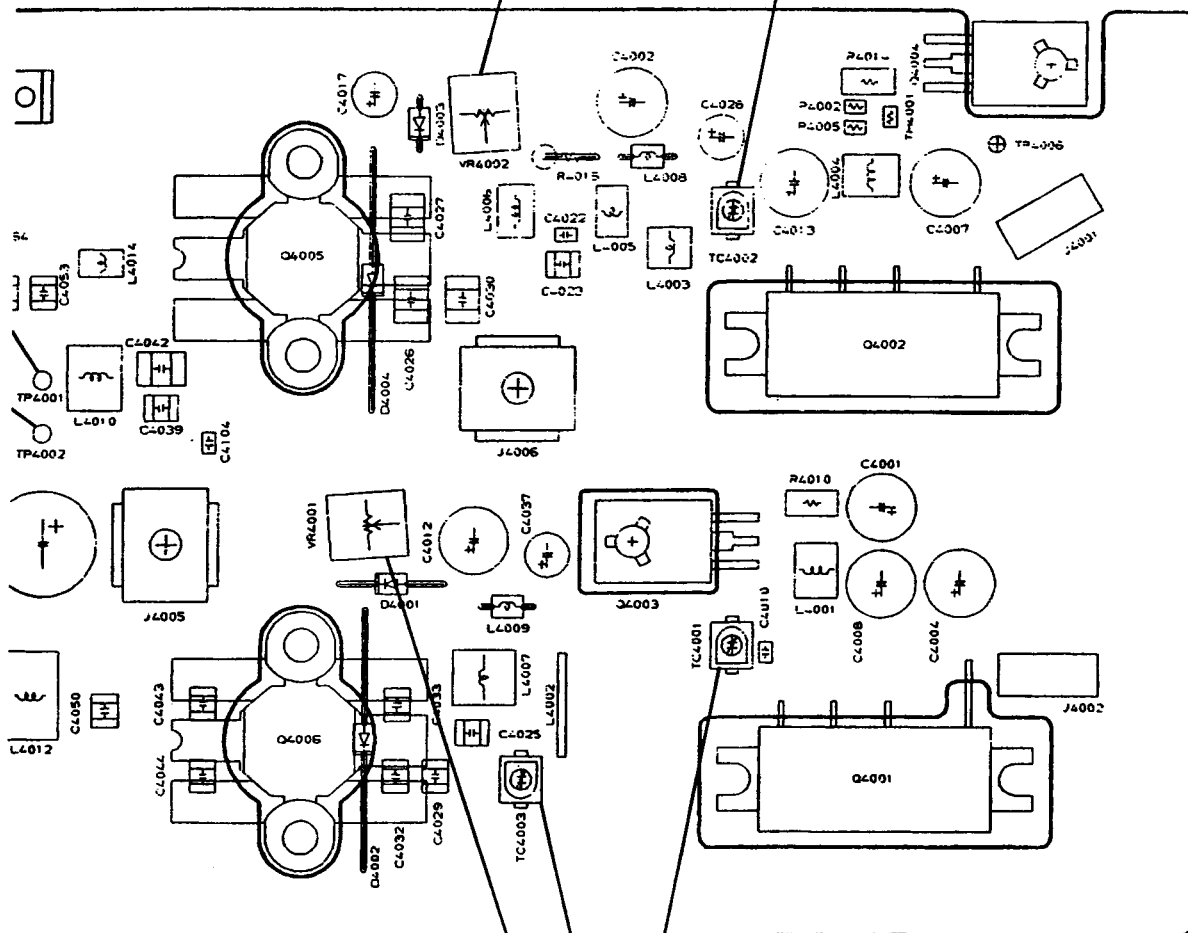

IF-PA Idling Current: Ammeter "+" lead ( $0.3 \pm 0.03A$ )

Idling Current: Ammeter "-" lead ( $0.3 \pm 0.03A$ )

Just

Just: DC Voltmeter (min.)

TC4001 430 MHz TX Adjust

TC4003 430 MHz TX Adjust

VR4001 UHF PA Idling Current

# PA Unit Alignment Points

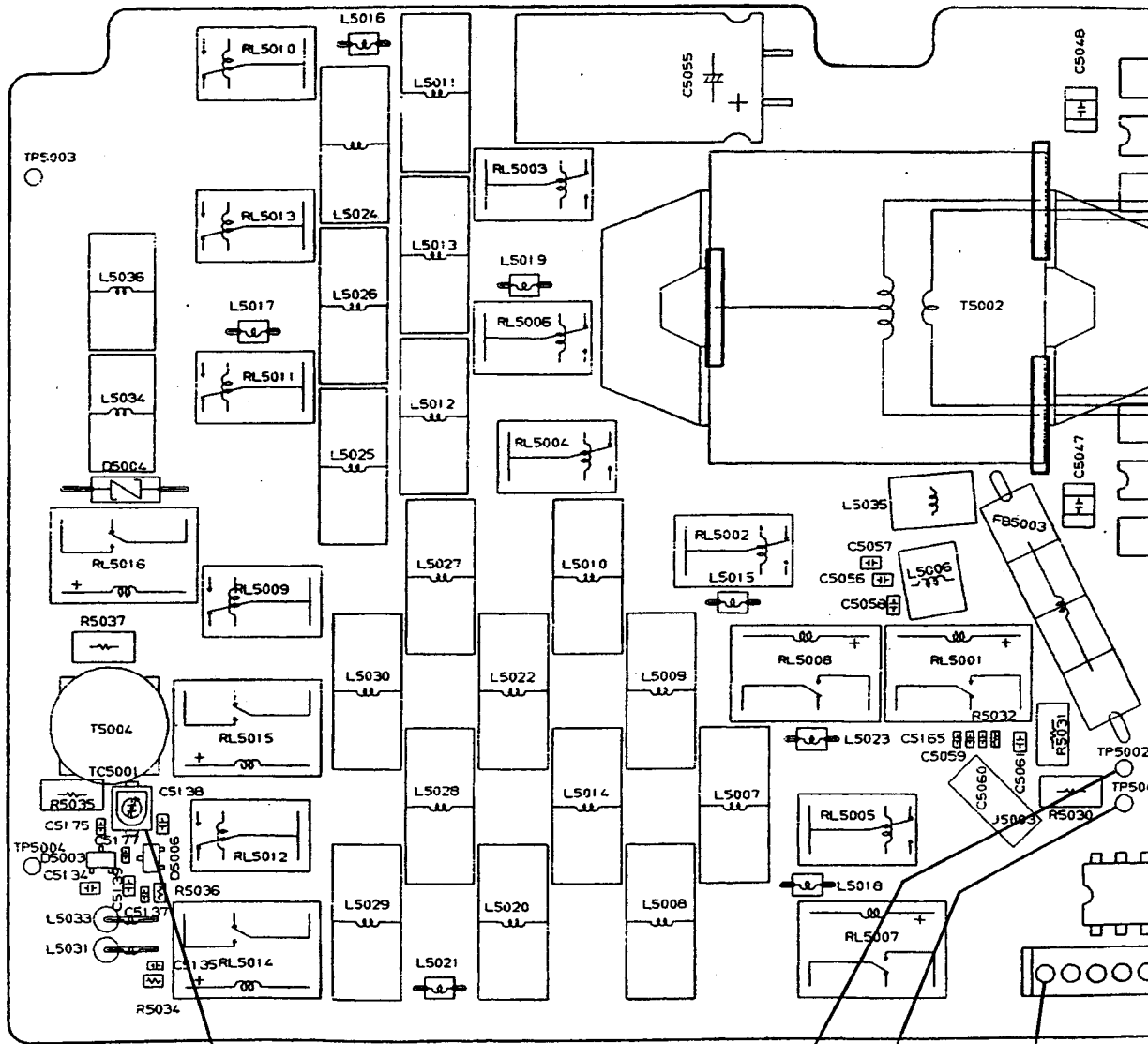

TC5001 CM Coupler Balance

J5005 Pin-1 CM

TP5001 PA Unit Final Section Idling Cur

TP5002 PA Unit Final Section Idling Current: Ammet

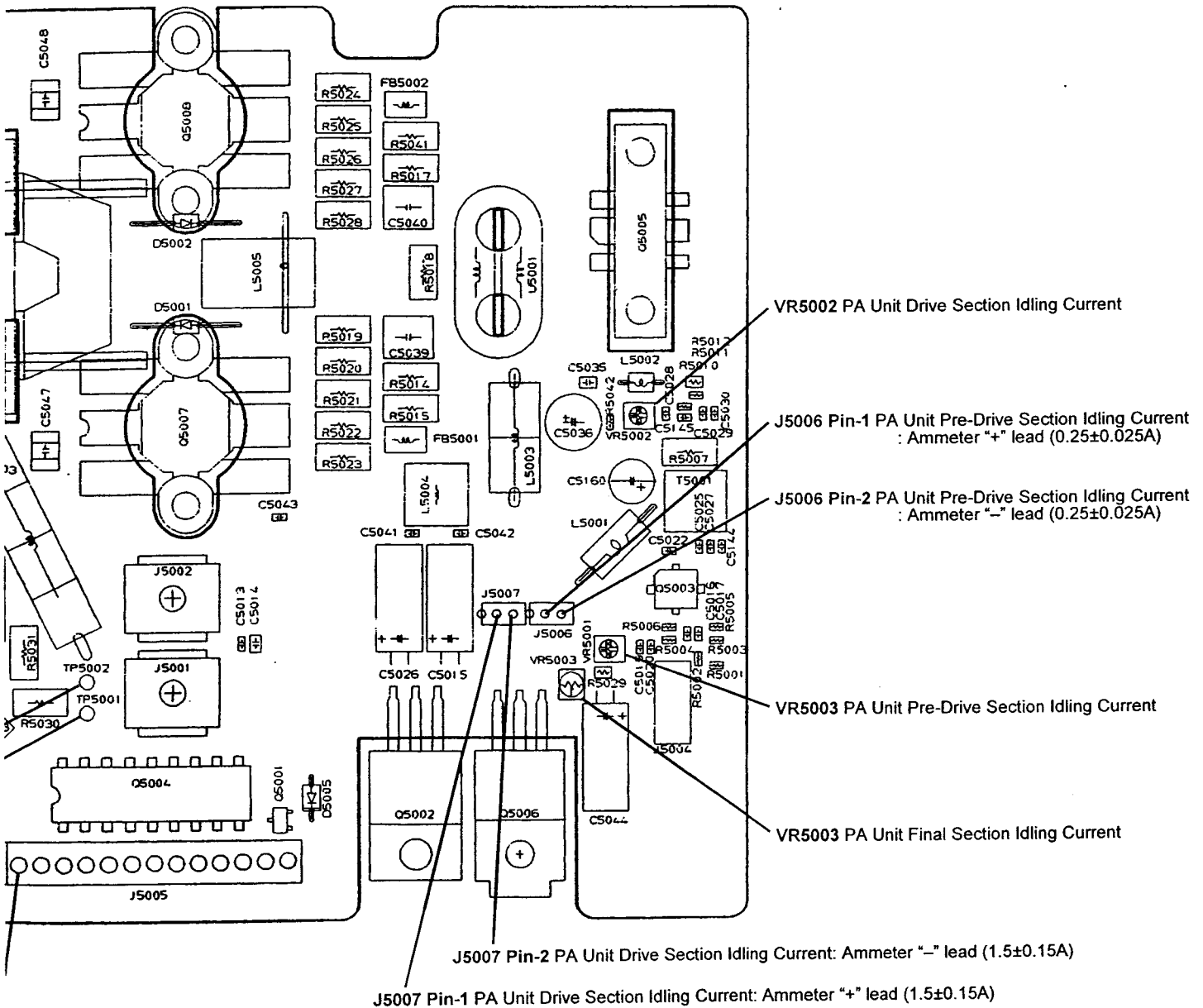

D5 Pin-1 CM Coupler Balance: DC Voltmeter (min.)

tion Idling Current: Ammeter "+" lead ( $0.42 \pm 0.025A$ )

urrent: Ammeter "-" lead ( $0.42 \pm 0.025A$ )

# Interconnection Diagram

