

YAESU

FT-50R

Technical Supplement

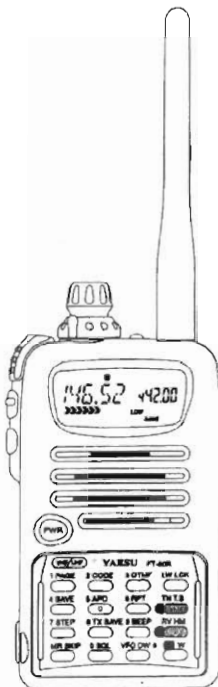

YAESU MUSEN CO., LTD.

1-20-2 Shimomaruko, Ota-Ku, Tokyo 146-8649, Japan

YAESU U.S.A.

17210 Edwards Rd., Cerritos, CA 90703, U.S.A.

YAESU EUROPE B.V.

P.O. Box 75525 1118 ZN, Schiphol, The Netherlands

YAESU UK LTD.

Unit 12, Sun Valley Business Park, Winnall Close
Winchester, Hampshire, SO23 0LB, U.K.

YAESU GERMANY GmbH

Am Kronberger Hang 2, D-65824 Schwalbach, Germany

YAESU HK LTD.

11th Floor Tsim Sha Tsui Centre, 66 Mody Rd.,
Tsim Sha Tsui East, Kowloon, Hong Kong

Contents

Introduction	1-1
Specifications	1-2
Chip Component Information	1-3
Transceiver Disassembly	2-1
Exploded View & Miscellaneous Parts	2-3
Alignment	2-5
<i>Resetting the CPU</i>	8
Circuit Description	3-1
Block Diagram	3-7
Interconnection Diagram	3-8
MOTHER Unit	4A-1
<i>Circuit Diagram</i>	1
<i>Parts Layout</i>	3
<i>Parts List</i>	5
144-VCO Unit	4B-1
<i>Circuit Diagram</i>	1
<i>Parts Layout</i>	1
<i>Parts List</i>	3
430-VCO Unit	4C-1
<i>Circuit Diagram</i>	1
<i>Parts Layout</i>	1
<i>Parts List</i>	3
CNTL Unit	4D-1
<i>Circuit Diagram</i>	1
<i>Parts Layout</i>	3
<i>Parts List</i>	5
VR Unit	4E
<i>Circuit Diagram</i>	1
<i>Parts Layout</i>	1
<i>Parts List</i>	1
FTT-11 DTMF Paging Keypad	5A-1
<i>Circuit Diagram</i>	1
<i>Parts Layout</i>	3
<i>Parts List</i>	5
FTT-12 Digital Voice Keypad	5B-1
<i>Circuit Diagram</i>	1
<i>Parts Layout</i>	3
<i>Parts List</i>	5

Cut out the label at the right, and place it behind the clear plastic window in the spine of the manual.



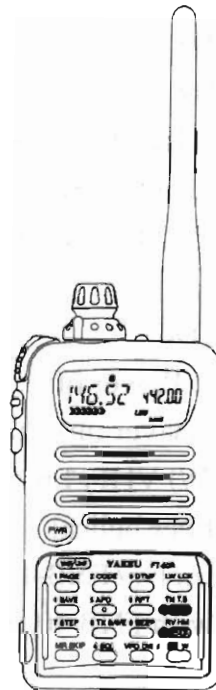

This manual provides technical information necessary for servicing the Yaesu FT-50R Dual-Band amateur hand-held transceiver. It does not include information on installation and operation, which are described in the FT-50R Operating Manual, provided with each transceiver, or on FT-50R accessories, which are described in manuals provided with each.

The FT-50R is carefully designed to allow the knowledgeable operator to make nearly all adjustments required for various station conditions, modes and operator preferences simply from the controls on the panels, without opening the case of the transceiver. The FT-50R Operating Manual describes these adjustments, plus certain internal settings.

Servicing this equipment requires expertise in handling surface mount chip components. Attempts by non-qualified persons to service this equipment may result in permanent damage not covered by warranty.

For the major circuit boards, each side of the board is identified by the type of the majority of components installed on that side.

In most cases one side has only chip components, and the other has either a mixture of both chip and lead components (trimmers, coils, electrolytic capacitors, packaged ICs, etc.), or lead components only.

While we believe the technical information in this manual is correct, Yaesu assumes no liability for damage that may occur as a result of typographical or other errors that may be present. Your cooperation in pointing out any inconsistencies in the technical information would be appreciated. Yaesu Musen reserves the right to make changes in this transceiver and the alignment procedures, in the interest of technological improvement, without notification of the owners.

Specifications

General

Frequency range:	
(transmit)	144 ~ 148 MHz, 430 ~ 450 MHz
(receive)*	76 ~ 200 MHz 300 ~ 400 MHz 400 ~ 540 MHz, 590 ~ 999 MHz (cellular blocked on 800 MHz)
Channel steps:	5, 10, 12.5, 15, 20, 25 & 50 kHz
Emission type:	F2, F3
Supply voltage:	4.0 ~ 16.0 V DC
Current consumption:	250 μ A Auto Power off 24 mA Stby (saver on), 200 mA Rx (approx.), 55 mA Rx (squelched) 1.5 A Tx (5 W) VHF, 1.6 A Tx (5 W) UHF
Antenna (SMA jack):	YHA-58 rubber helical
Case size (WHD)	57x99x30 mm (w/FNB-40)
Weight (approx.):	355 grams with FNB-40, antenna, belt clip

Receiver

Circuit type:	Double-conversion superheterodyne
IFs:	45.1 MHz & 450 kHz
Sensitivity:	0.16 μ V for 12 dB SINAD (VHF), 0.18 μ V for 12 dB SINAD (UHF)
Adj. Ch. Selectivity:	65 dB
Intermodulation:	65 dB
AF output:	0.5 W @ 8 Ω (10% THD)

Transmitter

Power output (@ 9.6 V):	approx. 5.0, 2.8, 1 & 0.1 W
Frequency stability:	better than \pm 5 ppm
Modulation system:	variable reactance
Maximum deviation:	\pm 5 kHz
FM Noise (@ 1 kHz):	better than -40 dB
Spurious emissions:	>60 dB below carrier
AF distortion (@ 1 kHz):	< 5%, w/3.0 kHz deviation
Microphone type:	2-k Ω condenser

**Specifications are subject to change without notice, and are guaranteed within amateur bands only.
Frequency ranges and repeater shift vary according to transceiver version, check with your dealer.*

Chip Component Information

The diagrams below indicate some of the distinguishing features of common chip components .

Capacitors

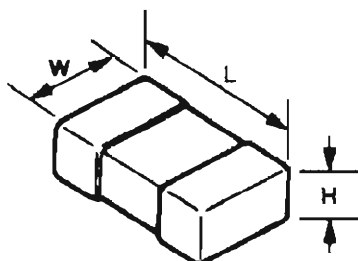

(Unit: mm)

Type	L	W	H
2125	2.0	1.25	0.35 ~ 0.5
1608	1.6	0.8	0.65 ~ 0.95
1005	1.0	0.5	0.45 ~ 0.55

Tantalum Capacitors

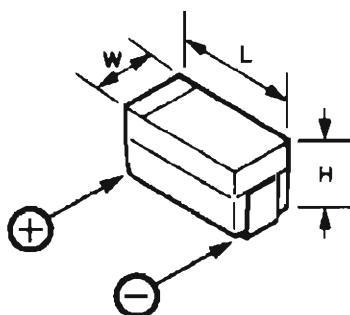

(Unit: mm)

Type	L	W	H
P	2.0	1.25	1.2
A	3.2	1.6	1.6
B	3.4	2.8	1.9
C	5.8	3.2	2.3

Resistors

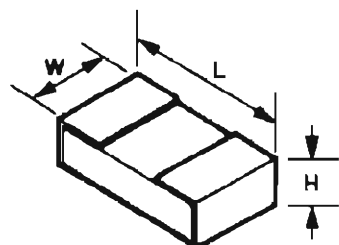

Marking* 100, 222, 473...

Ten unit	One unit	Multiplier code
0	0	10 ⁰
1	1	10 ¹
2	2	10 ²
3	3	10 ³
4	4	10 ⁴
5	5	10 ⁵
6	6	10 ⁶
7	7	10 ⁷
8	8	10 ⁸
9	9	10 ⁹

Indicated Letters

1 2 3 4 5 6 7 8 9 0 .

(Unit: mm)

Type	L	W	H
1/10	2.0	1.25	0.5
1/16	1.6	0.8	0.45
1/16S	1.0	0.5	0.35

Examples: 100=10Ω
222=2.2kΩ
473=47kΩ

Chip Component Information

Replacing Chip Components

Chip components are installed at the factory by a series of robots. The first one places a small spot of adhesive resin at the location where each part is to be installed, and later robots handle and place parts using vacuum suction.

For single sided boards, solder paste is applied and the board is then baked to harden the resin and flow the solder. For double sided boards, no solder paste is applied, but the board is baked (or exposed to ultra-violet light) to cure the resin before dip soldering.

In our laboratories and service shops, small quantities of chip components are mounted manually by applying a spot of resin, placing with tweezers, and then soldering by very small dual streams of hot air (without physical contact during soldering). We remove parts by first removing solder using a vacuum suction iron, which applies a light steady vacuum at the iron tip, and then breaking the adhesive with tweezers.

The special vacuum/desoldering equipment is recommended if you expect to do a lot of chip replacements. Otherwise, it is usually possible to remove and replace chip components with only a tapered, temperature-controlled soldering iron, a set of tweezers and braided copper solder wick. Soldering iron temperature should be below 280°C (536°F).

Precautions for Chip Replacement

- Do not disconnect a chip forcefully, or the foil pattern may peel off the board.
- Never re-use a chip component. Dispose of all removed chip components immediately to avoid mixing with new parts.
- Limit soldering time to 3 seconds or less to avoid damaging the component and board.

Removing Chip Components

- Remove the solder at each joint, one joint at a time, using solder wick whetted with non-acidic fluxes as shown below. Avoid applying pressure, and do not attempt to remove tinning from the chip's electrode.

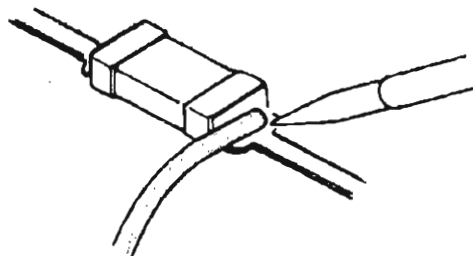

- Grasp the chip on both sides with tweezers, and gently twist the tweezers back and forth (to break the adhesive bond) while alternately heating each electrode. Be careful to avoid peeling the foil traces from the board. Dispose of the chip when removed.
- After removing the chip, use the copper braid and soldering iron to wick away any excess solder and smooth the land for installation of the replacement part.

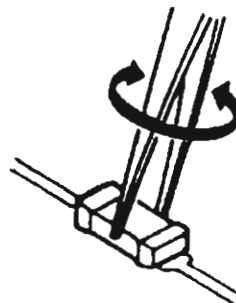

Installing a Replacement Chip

As the value of some chip components is not indicated on the body of the chip, be careful to get the right part for replacement.

- Apply a small amount of solder to the land on one side where the chip is to be installed. Avoid too much solder, which may cause bridging (shorting to other parts).

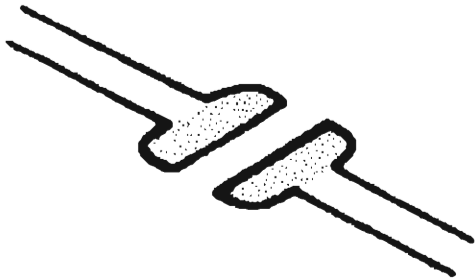

- Hold the chip with tweezers in the desired position, and apply the soldering iron with a motion line as indicated by the arrow in the diagram below. Do not apply heat for more than 3 seconds.

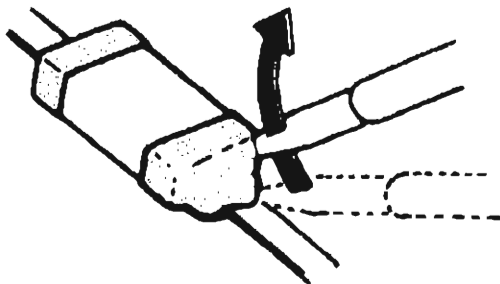

- Remove the tweezers and solder the electrode on the other side in the manner just described.

Chip Component Information

Notes:

Transceiver Disassembly

The FT-50R must be partially disassembled to perform a complete alignment.

Case Removal

Before beginning, turn the radio off, remove the knob, and the battery pack.

- Lay the transceiver on a flat surface covered with a soft cloth to protect the front case from marring, then remove the two rear-panel case screws (Fig. 1).

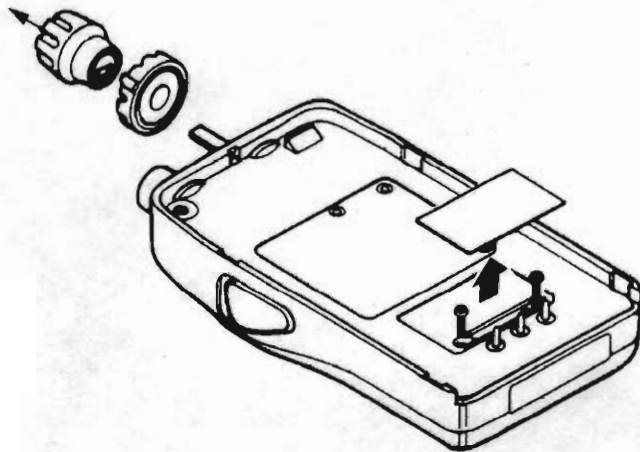

Figure 1.

- Remove the keypad unit from the front panel by using your fingernails to grasp both side of the unit and lift it free (Fig. 2).

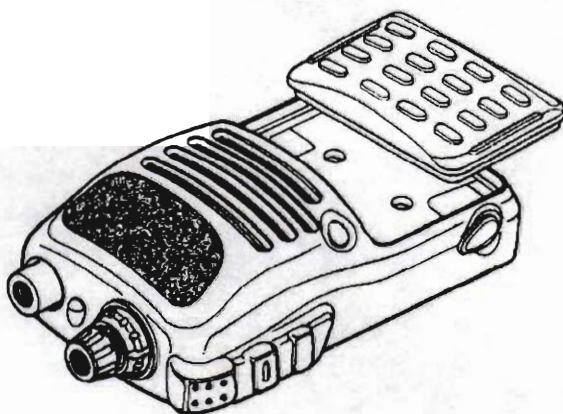

Figure 2.

- Grasp the transceiver with both hands, then gently remove the internal assembly from the case using by pressing on it gently with even pressure from both thumbs, then sliding out from the case at an angle (Fig. 3).

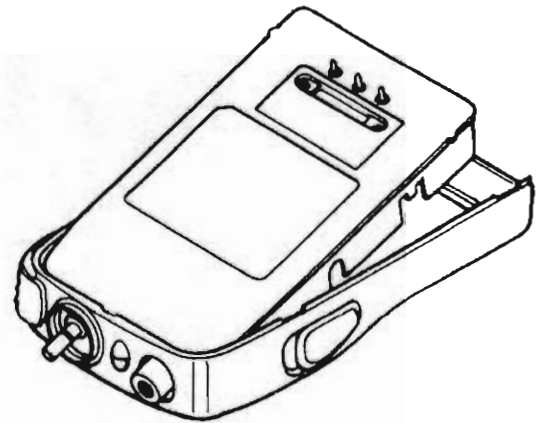

Figure 3.

- Remove the small silicone LED lens from the case by pressing on it from the inside.

This provides access to all user-serviceable adjustments, further disassembly is not recommended.

Refer repairs to your nearest Yaesu-authorized service center.

- Reassemble the unit in reverse order. When re-inserting the internal unit and keypad into the case, ensure their rubber gaskets are not pinched, and rest firmly within the ridge encircling their frame and transceiver case.

Transceiver Disassembly

Notes:

Exploded View & Miscellaneous Parts

REF.	YAESU P/N	Description	Qty.
①	U9900063	TAPTITE SCREW 2 × 3.3 Ni	2
②	U9900064	TAPTITE SCREW M2 × 10 Ni GUIDE	2
③	U9900066	TAPTITE SCREW M1.7 × 3 Ni #1	2
④	U9900068	TAPTITE SCREW M2 × 4 Ni #3	3
⑤	U9900069	TAPTITE SCREW M2 × 9.5 #2	3

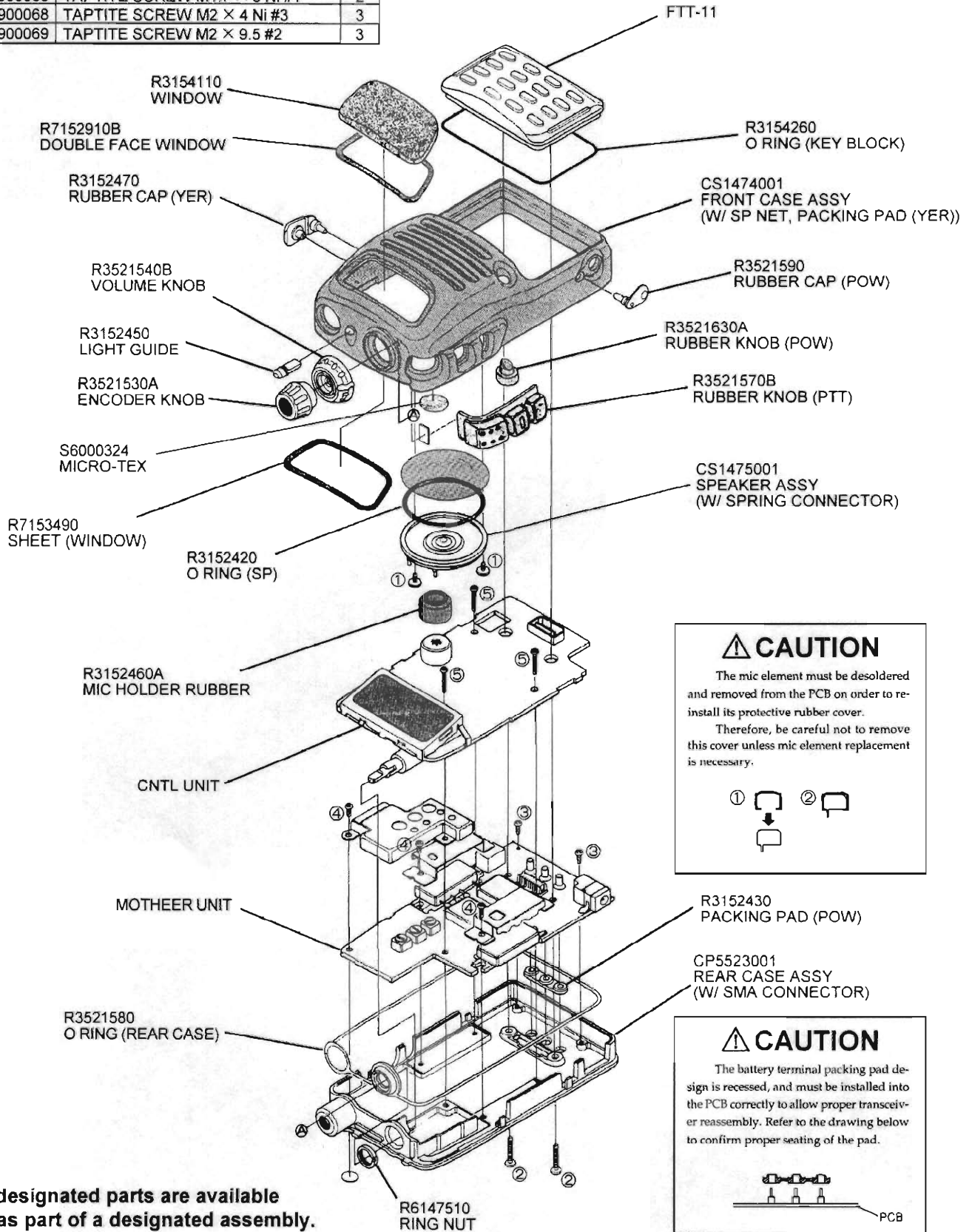

CAUTION

The mic element must be desoldered and removed from the PCB on order to re-install its protective rubber cover. Therefore, be careful not to remove this cover unless mic element replacement is necessary.

CAUTION

The battery terminal packing pad design is recessed, and must be installed into the PCB correctly to allow proper transceiver assembly. Refer to the drawing below to confirm proper seating of the pad.

Non-designated parts are available only as part of a designated assembly.

Exploded View & Miscellaneous Parts

Notes:



Introduction

The FT-50R is carefully aligned at the factory for the specified performance across the amateur band. Realignment should therefore not be necessary except in the event of a component failure. All component replacement and service should be performed only by an authorized Yaesu representative, or the warranty policy may be void. The following procedures cover the adjustments that are not normally required once the transceiver has left the factory. However, if damage occurs and some parts subsequently are replaced, realignment may be required. If a sudden problem occurs during normal operation, it is likely due to component failure; realignment should not be done until after the faulty component has been replaced.

We recommend that servicing be performed only by authorized Yaesu service technicians who are experienced with the circuitry and fully equipped for repair and alignment. If a fault is suspected, contact the dealer from whom the transceiver was purchased for instructions regarding repair. Authorized Yaesu service technicians realign all circuits and make complete performance checks to ensure compliance with factory specifications after replacing any faulty components. Those who do undertake any of the following alignments are cautioned to proceed at their own risk. Problems caused by unauthorized attempts at realignment are not covered by the warranty policy. Also, Yaesu reserves the right to change circuits and alignment procedures in the interest of improved performance, without notifying owners.

Under no circumstances should any alignment be attempted unless the normal function and operation of the transceiver are clearly under-

stood, the cause of the malfunction has been clearly pinpointed and any faulty components replaced, and realignment determined to be absolutely necessary.

The following test equipment (and familiarity with its use) is necessary for complete realignment. Correction of problems caused by misalignment resulting from use of improper test equipment is not covered under the warranty policy. While most steps do not require all of the equipment listed, the interactions of some adjustments may require that more complex adjustments be performed afterwards.

Do not attempt to perform only a single step unless it is clearly isolated electrically from all other steps. Have all test equipment ready before beginning and, follow all of the steps in a section in the order presented.

Required Test Equipment

- RF Signal Generator with calibrated output level at 500 MHz
- Deviation Meter (linear detector)
- In-line Wattmeter with 5% accuracy at 500 MHz
- 50- Ω , 10-W RF Dummy Load
- 8- Ω AF Dummy Load
- Regulated DC Power Supply adjustable from 3 to 15 VDC, 2A
- Frequency Counter: 0.2 ppm accuracy at 500 MHz
- AF Signal Generator
- AC Voltmeter
- DC Voltmeter: high impedance
- VHF Sampling Coupler
- SINAD Meter

Alignment

Alignment Preparation & Precautions

A 50-W RF load and in-line wattmeter must be connected to the main antenna jack in all procedures that call for transmission, alignment is not possible with an antenna. After completing one step, read the next step to see if the same test equipment is required. If not, remove the test equipment (except dummy load and wattmeter, if connected) before proceeding.

Correct alignment requires that the ambient temperature be the same as that of the transceiver and test equipment, and that this temperature be held constant between 20~30°C (68~86°F). When the transceiver is brought into the shop from hot or cold air, it should be allowed some time to come to room temperature before alignment. Whenever possible, alignments should be made with oscillator shields and circuit boards firmly affixed in place. Also, the test equipment must be thoroughly warmed up before beginning.

Note: Signal levels in dB referred to in the alignment procedure are based on $0\text{dBm}=0.5\mu\text{V}$.

Test Setup

Set up the test equipment as shown below for transceiver alignment, apply 12 VDC power to the transceiver. Refer to the drawings for Alignment Points.

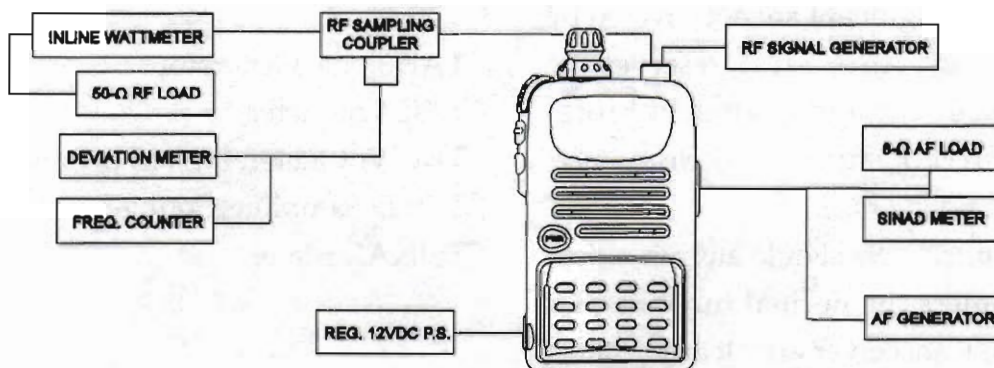

Rear Case Alignment Points and Connections (w/battery removed)

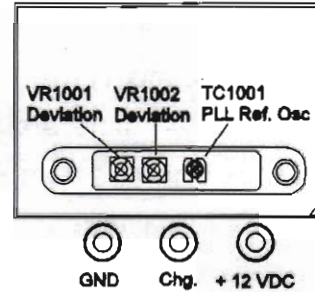

PLL Reference Frequency

With the wattmeter, dummy load and frequency counter connected to the antenna jack, and while tuned to the center of the band, transmit and adjust TC1001 on the RF Unit, if necessary, so the counter frequency is within 100 Hz of the displayed frequency on the FT-50R.

UHF Tx Deviation Adjustment

- With the wattmeter, dummy load and frequency counter connected to the antenna jack, adjust the AF generator attenuator level for 80 mVrms @ 1 kHz to the **MIC** jack.
- Transmit and adjust VR1002 to obtain 4.2-4.5 kHz indicated on the deviation meter (3.7-4.0 kHz for A1, A2A, A2B, A2C & A3 versions).

VHF Tx Deviation Adjustment

- With the wattmeter, dummy load and frequency counter connected to the antenna jack, adjust the AF generator attenuator level for 80 mVrms @ 1 kHz to the **MIC** jack.
- Transmit and adjust **VR1001** to obtain 4.2-4.5

kHz indicated on the deviation meter (3.7-4.0 kHz for A1, A2A, A2B, A2C & A3 versions).

CTCSS Tx Deviation Adjustment

- Tune to the center of either band, and enable 88.5 Hz CTCSS encode.
- With the wattmeter, dummy load and frequency counter connected to the antenna jack, transmit and adjust **VR2001** to obtain 0.5-0.7 kHz as indicated on the **deviation** meter.

VHF Interstage Transformer Alignment

- Connect the RF **signal generator** to the antenna jack, and connect a 8- Ω dummy load and SINAD meter to the **EAR** jack.
- Tune the transceiver and the RF signal generator to the VHF band center, and inject a signal modulated with 3.5 kHz deviation of a 1-kHz tone.
- Adjust **L1040~1042** for optimum 12dB SINAD.

UHF Interstage Transformer Alignment

- Connect the RF **signal generator** to the antenna jack, and connect a 8- Ω dummy load and SINAD meter to the **EAR** jack.
- Tune the transceiver and the **RF signal generator** to the **UHF band center**, and inject a **signal modulated** with 3.5 kHz deviation of a 1-kHz tone.
- Adjust **TC1002~1005** for optimum 12 dB SINAD.

This completes the **first** part of the alignment, now proceed to the *Internal System Alignment Routine*.

Internal System Alignment Routine

This uses a programmed routine in the transceiver which simplifies many previously complex discrete component settings and adjustments with digitally-controlled settings via front

panel buttons and LCD indications. Transceiver adjustments include:

- Squelch Hysteresis
- Squelch Threshold & Tight Adjustment
- S-Meter Full Scale & S-1 Adjustment
- Power Output Adjustment (Hi/L3/L2/L1)

UHF Alignment

- To begin, set the transceiver to the center of the UHF band, then turn the transceiver off.
- Next, *press and hold* the knob, PTT and **LAMP** button together while powering the radio again. The display shows the first setting.

Note that the first settings is not adjustable and is left as set from the factory.

In the alignment, each adjustment is selected by rotating the knob. Alignment is performed by **pressing** the knob, then injecting a signal of the required frequency and level.

Pressing knob after a level setting or adjustment is made stores the entry. To exit the alignment routine, press **PWR**. After performing the system alignment in its **entirety**, individual settings can be returned to and adjusted should the need arise.

Squelch Hysteresis Adjust (UHSSQ)

- Select the squelch hysteresis level by DIAL.

Squelch Preset Threshold (UTHSQ)

- Inject a -13dB μ RF signal (3.5kHz deviation @ 1-kHz), then double press the knob and rotate it for **the next setting**.

Squelch Preset Tight (UTISQ)

- Adjust the generator level for a -5dB μ signal, then double press the knob and rotate it for **the next setting**.

Low-Scale S-1 Adjustment (US1LV)

- Adjust the generator level to -2dB μ , then double press the knob and rotate it for **the next setting**.

Alignment

S-Meter Full-Scale Adjust (US9LV)

- Adjust the generator level to +23dB μ , then double press the knob and rotate it for the next setting.

High TX Power Adjust (UHIPO)

- Transmit and adjust the output power level for 5 W by rotating the knob.

- Press the knob to save the entry and move on.

L3 Tx Power Adjust (UL3PO)

- Transmit and adjust the output power level for 2.8 W using the knob.

- Press the knob to save the entry and move on.

L2 Tx Power Adjust (UL2PO)

- Transmit and adjust the output power level for 1 W by rotating the knob.

- Press the knob to save the entry and move on.

L1 Tx Power Adjust (UL1PO)

- Transmit and adjust the output power level for 0.1 W using the knob. Press the knob to save the entry and move on.

- This completes the UHF internal alignment routine, to save all settings and exit, press the knob for more than second.

VHF Alignment

- To begin, set the transceiver to the center of the VHF band, then turn the transceiver off.

- Next, *press and hold* the knob, PTT and **LAMP** button together while powering the radio again. The display shows the first setting.

Squelch Hysteresis Adjust (HSSQ)

- Select the squelch hysteresis level by rotating the knob.

Squelch Preset Threshold (THSQ)

- Inject a -13dB μ RF signal (3.5kHz deviation @ 1-kHz), then double press the knob and rotate it for the next setting.

Squelch Preset Tight (TISQ)

- Adjust the generator level for a -5dB μ signal,

then double press the knob and rotate it for the next setting.

Low-Scale S-1 Adjustment (S1LV)

- Adjust the generator level to -2dB μ , then double press the knob and rotate it for the next setting.

S-Meter Full-Scale Adjust (S9LV)

- Adjust the generator level to +23dB μ , then double press the knob and rotate it for the next setting.

High TX Power Adjust (HIPO)

- Transmit and adjust the output power level for 5 W by rotating the knob.

- Press the knob to save the entry and move on.

L3 Tx Power Adjust (L3PO)

- Transmit and adjust the output power level for 2.8 W using the knob.

- Press the knob to save the entry and move on.

L2 Tx Power Adjust (L2PO)

- Transmit and adjust the output power level for 1 W by rotating the knob.

- Press the knob to save the entry and move on.

L1 Tx Power Adjust (L1PO)

- Transmit and adjust the output power level for 0.1 W using the knob. Press the knob to save the entry and move on.

- This completes the VHF internal alignment routine, to save all settings and exit, press the knob for more than second. To exit the alignment routine, press **PWR**.

Resetting the CPU

If you are unable to gain control of the transceiver (or if you want to clear all memories and settings to their factory defaults), press down and hold both the knob, and the center **MON** button while also holding the **PWR** button for 1/2 second to turn the transceiver on.

The FT-50 is composed of the Mother-Unit, CNTL-Unit and the respective sub-units connected to them. The Mother-Unit contains the front-end receiver, IF, PLL circuit, demodulation circuit, switching circuit and the VCO-Unit for generation of transmission and local signals. The CPU, audio circuit and LCD display are in the CNTL-Unit, and the Key-Unit and the VR-Unit are connected.

There are two types of Key-Units: the standard 16 Key Unit (FTT-11) and the optional 16 Key-Full featured Unit (FTT-12). The FTT-12 is comprised of a DTMF and CTCSS decode IC, and digital voice recording circuitry.

Receive

Antenna Duplexer

RF input enters the antenna terminal and passes through the 430 MHz LPF composed of C1044, C1045, 1046, L1008, L1009 and L1010, and 145 MHz input is fed to the RF amplifier through the 145 MHz LPF consisting of C1040, C1041, C1242, C1043, L1006, L1007 and L1008 as well as the antenna switching circuit consisting of D1006, D1008 (RLS135) and L1004. The UHF input passes through a 430 MHz LPF and 430 MHz HPF consisting of C110, C111, C115 and L1024, a LPF composed of C1112, C1114 and L1022 and the antenna switching circuit made up of D1016, D1018 (RLS135), C1118 and L1021.

Accordingly, the 430 & 145 MHz LPF and 430 MHz HPF constitute the duplexer, it separates VHF and UHF signals.

VHF Reception

VHF input passes through the duplexer circuit, the antenna switching circuit, and the HPF consisting of C1068, C1069, C1070 and L1015. It is then amplified by Q1023 (**2SC4226-R24**) of the

RF amplifier and passes through the 3-stage variable BPF consisting of C1054, C1055, C1057, C1062, C1065, D1001, D1010, D1011 (HVU359), L1040, L1041 and L1042 to enter Q1022 (**2SC4226-R24**) of the 1st mixer. The tuning voltage of this frequency-variable BPF is supplied from the APC line of the CPU through Q1025 (**TC75S51F**) of the level shift amplifier.

Conversely, the output of the 144-VCO-Unit (pin 7, OUT) is amplified by Q1007 (**2SC4537**) and added to Q1022 of the 1st mixer as the 1st local signal by D1004 (**DAN222**) diode switch during reception. The received signal is converted to the 1st IF frequency (45.1 MHz), and after the conversion, it enters the band change over switch D1036 (**DAN222**).

UHF Reception

UHF input passes through the duplexer, antenna switch and the variable BPF consisting of C1185, C1190, D1035 (**HVU350**), L1033 and TC1005, and is amplified by Q1044 (**2SC4227**) of the RF amplifier. After amplification, it passes through the two-stage variable BPF made up of C1189, D1033 (**HVU350**), L1032, TC1004 and C1188, D1032 (**HVU350**) L1031 and TC1003 and is amplified by the second-stage amplifier Q1043 (**2SC4227**). It then passes through the variable BPF consisting of C1187, D1030 (**HVU350**), L1030 and TC1002, and enters Q1042 (**2SC4226-R24**) of the 1st mixer. The tuning voltage of this frequency variable BPF is supplied from APC line of the CPU through the level shift amplifier Q1025 (**TC75S51F**).

Conversely, the output of the 430-VCO-Unit (No. 7 pin, OUT) is amplified by Q1030 (**2SC4245**) and added to Q1042 of 1st mixer as the 1st local signal by D1014 (**DAN222**) diode switch during reception. The received signal is

Circuit Description

converted to the 1st IF frequency (45.1 MHz), and after the conversion, it enters the band change over switch D1036 (**DAN222**).

IF Processing

The signal that passed through the band change over switch passes through a monolithic crystal filter (MCF) XF1001 and is amplified by the IF amplifier Q1041 (**2SC4215Y**) to enter IF-IC Q1040 (**TK10930V**).

Also, the 2nd IF signal is mixed with the 2nd local signal (44.645 MHz) generated inside X1002 and IF-IC by the 2nd mixer inside IF-IC and is converted to 2nd IF signal (455 kHz).

This signal passes through the ceramic filter CF1001 (**MCFH455ELM01**), and after amplification by IF-IC limiting amplifier, it is quadrature detected by ceramic discriminator CD1001 (**CDBM455C7T**). The audio signal is output from the IF IC and is input into CNTL-Unit through the connector J1001.

Squelch Control

The signal component in the neighborhood of 15 kHz, that is included in the detection output passes through the active BPF comprising C1161, C1162, R1090, R1091 and R1094, and the operation amplifier inside the IF-IC, and is rectified by D1028 (**DA221**) to produce a DC voltage in proportion to the noise volume.

This voltage is input to the pin 99 of CPU Q2016 (**HD6473877**) of the CNTL-Unit. It is compared with the threshold value preset in the CPU and if it is lower than this value, the 11th pin of the CPU becomes H and the Q2024 (**TC7S66FU**) switch is turned ON. The detected signal is propagated and the voice is output.

In addition, the CPU generates serial data which pass through D/A converter Q2009 (**MB88347LPFV**) to turn ON the switch Q2008

(**FMG2**) to light up the BUSY lamp D2004 (green side of **CL-155UR/G-D-T**).

Voice Output

The detection signal of the Mother-Unit passes through the analog switch Q2024 (**TC7S66FU**) of the CNTL-Unit to add peep sound during key operation or DTMF sound, and the frequency characteristics are flattened by the de-emphasis circuit of Q2018-1 (**NJM3403AV**). Then it enters the audio amplifier Q2022 (**TDA7233D**) through the volume device of VR- Unit.

This audio drives the built-in speaker or an external speaker through the Jack J2003. Moreover, DCS decode signal propagates through Q2015-1 (**NJM2904V**) low-pass filter, its waveform is shaped by D2006 (**DA204U**), is amplified by Q2015-2 and enters the CPU.

Transmitter

Transmitter Audio Stages

Voice audio is input through the built-in microphone MC2001 (**WM-54BM**) or the external Jack J2003, passes through the microphone amplifier circuit Q2018-1 (**NJM3403AV**), limiter amplifier circuit Q2018-3 and the pre-emphasis circuit made up of C2045, C2046, Q2018-2, R2074 and R2075, and enters the Mother-Unit.

During DTMF transmission, output from the CPU and is fed to the input section of the Q2018-3 limiter amplifier circuit and DTMF signal can be monitored from the speaker. Also, pin 14 of the CPU goes "high" and DC is supplied to the mike amplifier circuit Q2018-4 to mute the audio signal (voice) from the mike.

During CTCSS transmission, output from pin 90 of the CPU and the deviation is adjusted by VR2001. The signal then enters the Mother-Unit together with voice.

VHF Band Transmitter

The AF signal from the CNTL-Unit enters the Mother-Unit, and after passing through the deviation control (volume) VR1001, it is input into pin 3 (MOD terminal) of the 144-VCO-Unit. While receiving, the AF signal is shorted by Q1001 (DTC124EE) and modulation does not take place. Audio entering 144-VCO-Unit is frequency-modulated by modulation diodes D4003 (HSU277) and Q4001 (2SC4226). The VCO is locked by the PLL circuit at the frequency to be finally transmitted, and the output is buffer-amplified by Q4002, Q4003 (2SC4226).

The output from 144-VCO-Unit (pin 7, OUT) is amplified by the driver amplifier Q1007 (2SC4357) and passes through the diode switch D1004 (DAN222) to enter pin 1 (IN terminal) of the power module Q1010 (S-AV30H). The power module gain is controlled by the APC circuit. The output from the power module passes through the antenna switch and the duplexer, and is output to the antenna terminal.

VHF Band APC

A portion of the power module output is taken out from both the terminals of L1007 of the LPF out of C1027, C1028, R1021 and R1022 and detected by Schottky diode D1007 (1SS321). It is fed to the APC circuit as a DC signal in proportion to the output level.

After amplification by Q1009-1 (NJM2904V), this signal is compared with the APC voltage from the CPU by the operation amplifier Q1009-2 (NJM2904V). The APC voltage will vary at High, Low 3, Low 2 and Low 1 of the transmission output. This APC output is fed to the 2nd pin (gate terminal) of the power module to control the transmission output.

When PLL is analog during transmission, an-

alog signal from PLL-IC is transmitted to CPU through Q1027 (DTA124EE), and serial data are sent to PLL-IC so as to put the CPU in the receiving condition and stop the power supply to APC circuit and antenna switch.

VHF Band Transmit Switching

When the PTT switch S2002 of the CNTL-Unit is pressed, the base of Q2017 (DTA144EU) becomes "low" and the collector becomes "high" and is added to the pin 95 of CPU Q2016. The CPU detects that the PTT is pressed.

The information, that PTT is pressed, is detected by the CPU and is converted into serial data which are sent to PLL-IC Q1024 (FQ7925) of the Mother-Unit. The No.3 pin of Q1024 changes from "high" to "low". This operation turns Q1005-R (UMB3N) OFF and the receiving circuit stops operation.

Moreover, Q1006-L (UMB3N) goes ON and the 3-volts power supply for 145 MHz band transmission system comprising Q1020 (2SB1132Q) and Q1021 (UMW1N) is turned ON. The VCO output diode switch is changed over to transmission side and the action of APC circuit changes over the antenna switch to the transmission side and operates the power module to supply the transmission output to the antenna terminal.

Besides, CPU generates serial data and turns the switch Q2008 (FMG2) ON through D/A converter Q2009 (MB88347LPFV) to light up the BUSY lamp D2004 (red side of CL-155UR/G-D-T).

UHF Band Transmitter

The AF signal from the CNTL-Unit enters the Mother-Unit, and after passing through the deviation adjustment volume VR1002, it is input into the pin 3 (MOD terminal) of the 430-VCO-Unit. While receiving, the AF signal is shorted

Circuit Description

by Q1001 (DTC124EE) and modulation does not take place. The AF signal entering 430-VCO-Unit is frequency-modulated by modulation diodes D5003 (**HSU277**) and Q5001 (**2SC5006**). The VCO is locked by PLL circuit at the frequency to be finally transmitted and the output is buffer-amplified by Q5002, Q5003 (**2SC5006**).

The output from 430-VCO-Unit (pin 7, OUT) is amplified by the driver amplifier Q1030 (**2SC4245**), passes through the diode switch D1013 (**DAN222**) and is amplified by Q1032 (**2SC4537**) to enter pin 1 (IN terminal) of the power module Q1034 (**M67799MA**). The power module gain is controlled by APC circuit. The output from the power module passes through the antenna switch, LPF, and the duplexer and is output to the antenna terminal.

VHF Band APC

A part of the power module output is taken out from the both terminals of L1022 of LPF out of C1108, C1109, R1067 and R1068 and is detected by Schottky diode D1017 (**1SS321**). It is fed to APC circuit as a DC signal in proportion to the output level.

After amplification by Q1033-1 (**NJM2904V**), this signal is compared with APC voltage from the CPU by the operation amplifier Q1033-2 (**NJM2904V**). The APC voltage will vary at High, Low 3, Low 2 and Low 1 of the transmission output. This APC output is fed to the pin 2 (gate terminal) of the power module to control the transmission output.

When PLL is analog during transmission, the analog signal from PLL-IC is transmitted to CPU through Q2027 (**2SC4116GR**), and serial data are sent to PLL-IC so as to put the CPU in the receiving condition and to stop the power supply to APC circuit and antenna switch.

UHF Band Transmit Switching

When the PTT switch S2002 of the CNTL-Unit is pressed, the base of Q2017 (**DTA144EU**) becomes "low" and the collector becomes "high" and is added to the pin 95 of the CPU, which detects that the PTT is pressed.

The CPU converts the information, that PTT is pressed, into serial data which are sent to Q1024 (**FQ7925**) PLL-IC of the Mother-Unit. The No. 3 pin of Q1024 changes from "high" to "low". This operation turns Q1005-R (**UMB3N**) OFF and the receiving circuit stops operation.

Moreover, Q1006-R (**UMB3N**) goes ON and the 3-volt power supply for 435 MHz band transmission system comprising Q1018 (**2SB1132Q**) and Q1019 (**UMW1N**) is turned ON. The VCO output diode switch is changed over to the transmission side and the action of APC circuit changes over the antenna switch to transmission side and operates the power module to supply the transmission output to the antenna terminal.

Besides, CPU generates serial data and turns the switch Q2008 ON through D/A converter Q2009 (**MB88347LPFV**) to light up the BUSY lamp D2004 (red side of **CL-155UR/G-D-T**).

PLL frequency synthesizer

PLL-IC Q1024 (**FQ7925**) of Mother-Unit is composed of a data shift register, a standard frequency divider, a comparison frequency divider, a phase comparator, a charge pump, an intermittent operation control circuit and a band changer.

After the PLL data from the CPU are converted to parallel data by the shift register inside PLL-IC. They enter comparison frequency divider and the standard frequency divider through the latch and set the respective frequency division ratio.

The 12.8MHz signal is generated by the reference oscillation circuit comprising Q1038 (**2SC4116GR**) and X1001 and is fed to PLL-IC. DCS encode signal modulates the reference oscillation frequency by variable capacitor D1026 (**1SV230**).

VHF Transmitter and Reception

The output generated by Q4001 (**2SC4226**) 144-VCO-Unit is input into PLL-IC through the buffer amplifier Q4003 (**2SC4226**) and is frequency-divided by comparison frequency divider inside the PLL-IC and becomes the comparison frequency and is input to the phase comparator.

The phase comparator makes comparison with the phase of the standard frequency and outputs pulses in proportion to the phase difference. These pulses are input to the charge pump and the output of the charge pump passes through the loop filter consisting of C1071, C1072, C1074, L1001, R1038, R1039 and R1040 to be converted into voltage proportionately with the pulses. This is the control voltage (VCV). The control voltage (VCV) changes the oscillation frequency of the VCO and controls the oscillation voltage so that the phase difference between the standard frequency and the comparison frequency becomes constant, and then locks the frequency. The frequency to be locked at is determined by the frequency division ratio from the CPU.

Moreover, during power saving, PLL circuit operates intermittently to keep the current consumption low, and at the same time the intermittent operation circuit acts to shorten the lock up time.

UHF Transmitter and Reception

The output generated by the 430-VCO-unit Q5001 (**2SC5006**) is input into PLL-IC through

the buffer amplifier Q5003 (**2SC5006**) and is frequency-divided by comparison frequency divider inside the PLL-IC and becomes the comparison frequency which is input to the phase comparator.

The phase comparator makes comparison with the phase of the standard frequency and outputs pulses in proportion to the phase difference. These pulses are input to the charge pump and the output of the charge pump passes through the loop filter consisting of C1010, C1011, C1012, C1074, L1001, R1004, R1005 and R1040 to be converted to voltage proportionately with the pulses. This is the control voltage (VCV). The control voltage (VCV) changes the oscillation frequency of VCO and controls the oscillation voltage so that the phase difference between the standard frequency and the comparison frequency becomes constant, and then locks the frequency. The frequency to be locked at is determined by the frequency division ratio from the CPU.

Moreover, during power saving, PLL circuit operates intermittently to keep the current consumption low, and at the same time the intermittent operation circuit acts to shorten the lock up time.

Other Circuits

Power Supply

The Mother-Unit switches between BATT and external DC sources by diode D1022 and D1023 (**HRF302A**), and it is so devised that the one with higher voltage will output to the power supply line (+B). When external DC is used, the low current circuit consisting of Q1035 (**2SB1132Q**), R1069, D1021 (**02CZ2.0X**) and R1070 operates and charges the BATT (battery). The power sup-

Circuit Description

ply line (+B) coming out from D1022 and D1023 is supplied to each unit.

Power Supply Switch

In order that ON or OFF of the power supply line (+B) is not done directly, always 3V-supply is applied to CPU through the regulator IC Q2002 (**S-81233SG-QF**).

When the power switch (S2001) of the CNTL-Unit is pushed, a supply of 3V is applied to the pin 94 of the CPU and at the same time, the pressing of the power switch is detected, as pin 8 goes L for a moment. This makes the CPU start operation.

16 Key-Full-Unit FTT-12

The FTT-12 senses the key pressed by Q1001 (**BU4094BCFV**) and Q1004 (**BU4021BF**) and transmits the signal through serial data to the CNTL-Unit. In addition, DETM is decoded by Q1005 (**TC35305F-11**) and CTCSS is decoded by Q1006 (**MX165CTN**).

The recording and reproduction IC Q1003 (**ISD1020AGL**) records the received signal from the output of the pre-emphasis circuit Q2018-2 of the FT-50 through the analog switch Q2028 (**TC7S66FU**). The reproduced sound is input to the de-emphasis circuit Q2018-1 for speaker output.

Block Diagram

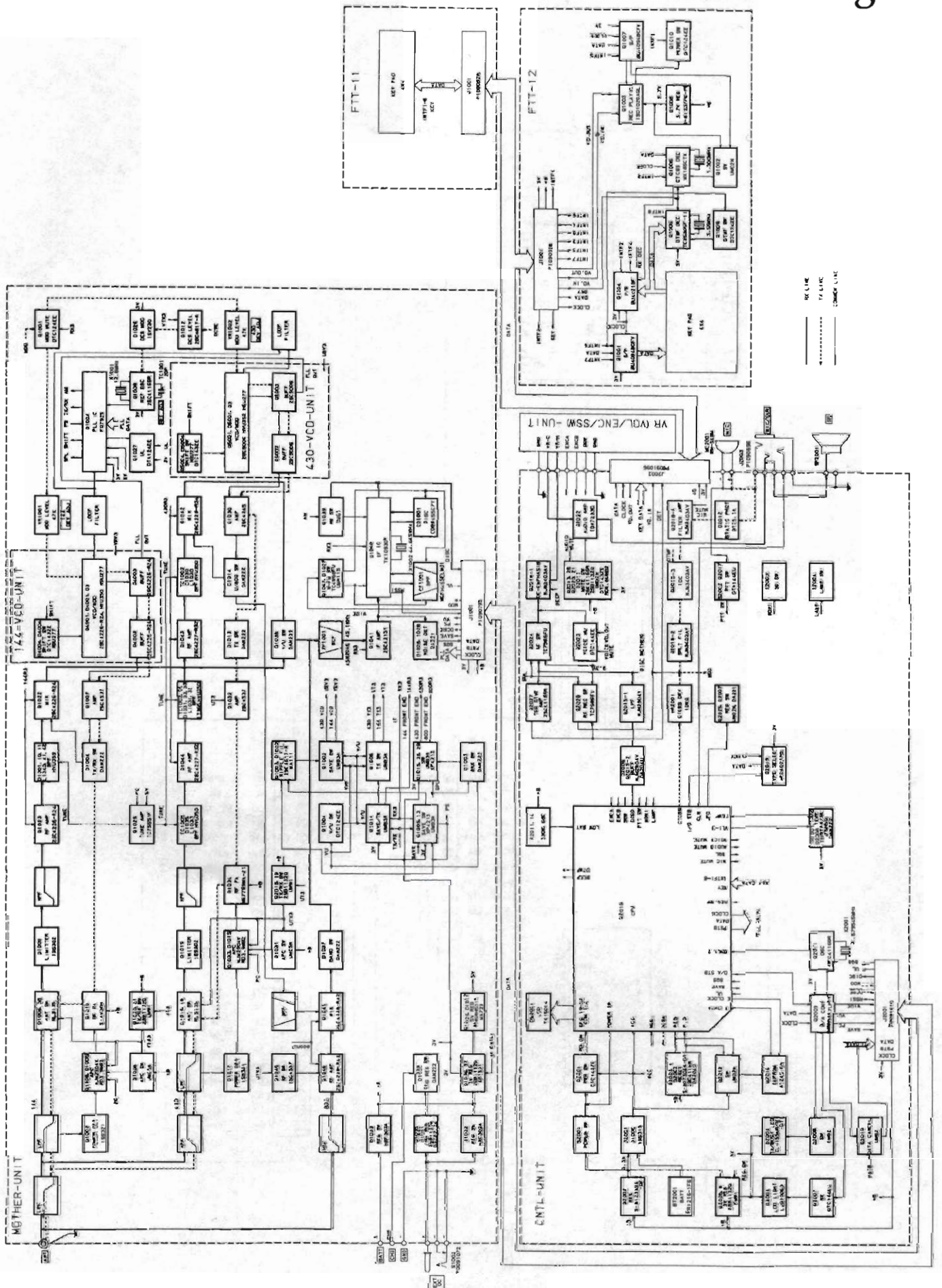

Interconnection Diagram

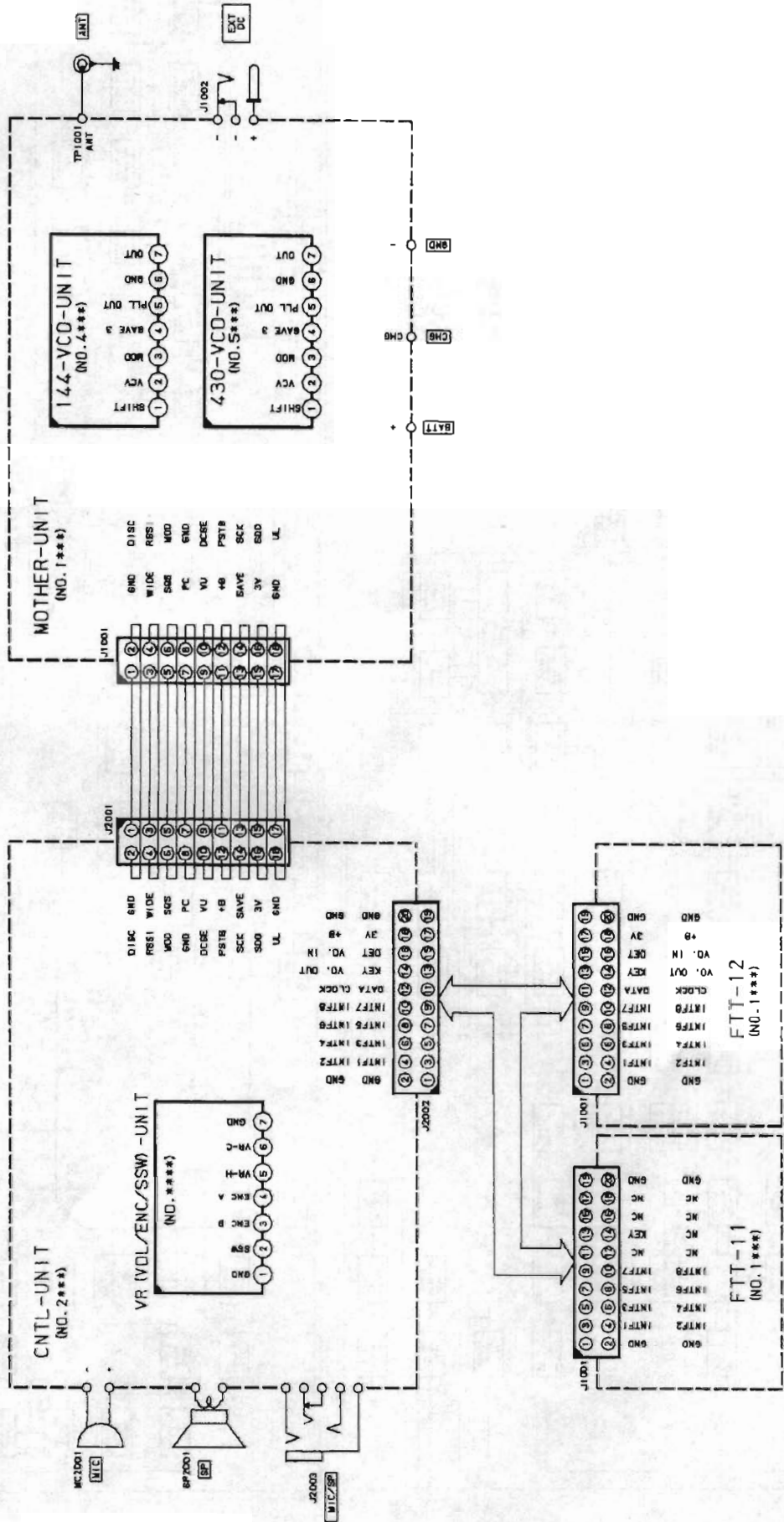

Circuit Diagram

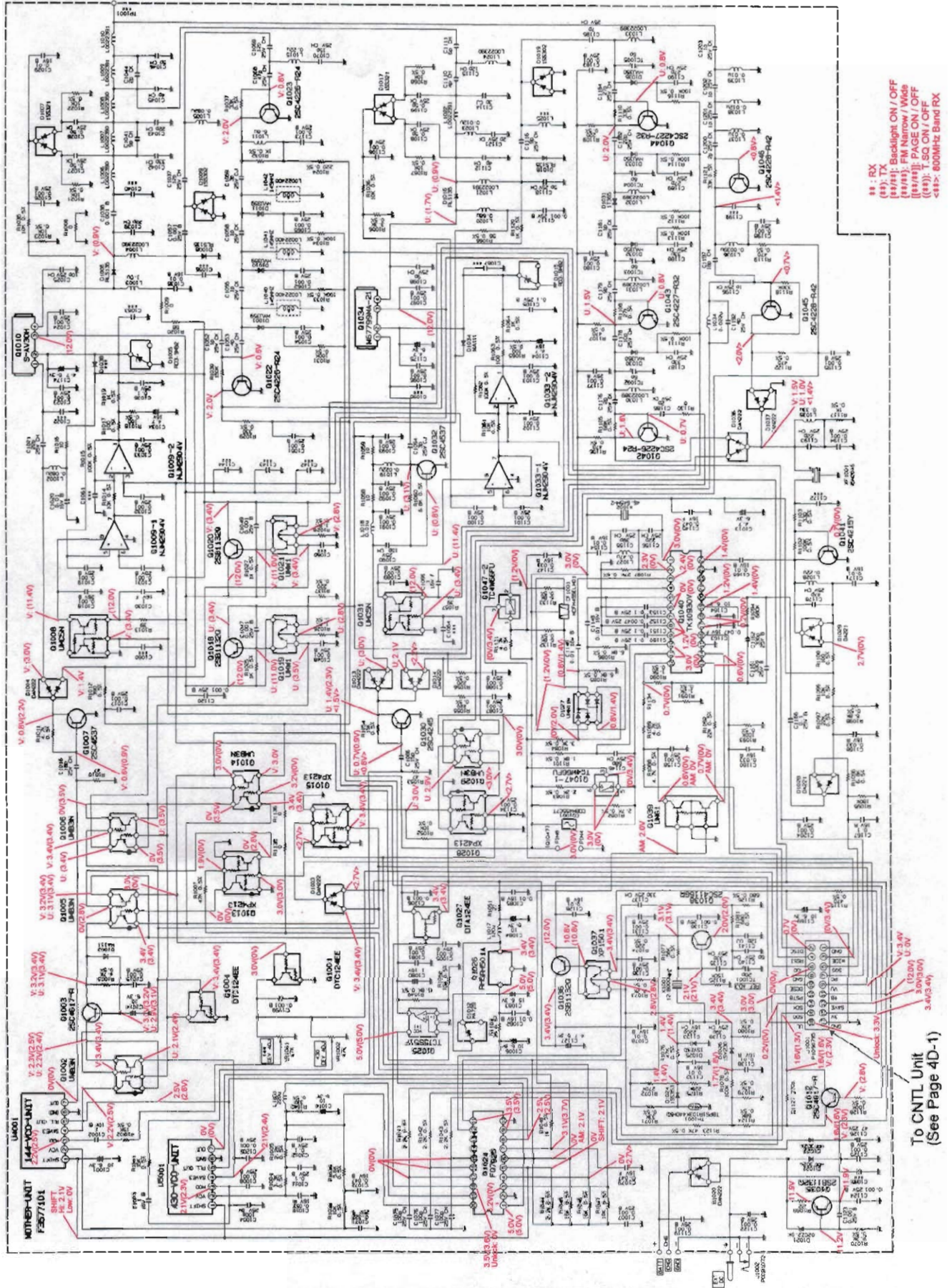

MOTHER Unit

Notes:



Circuit Diagram

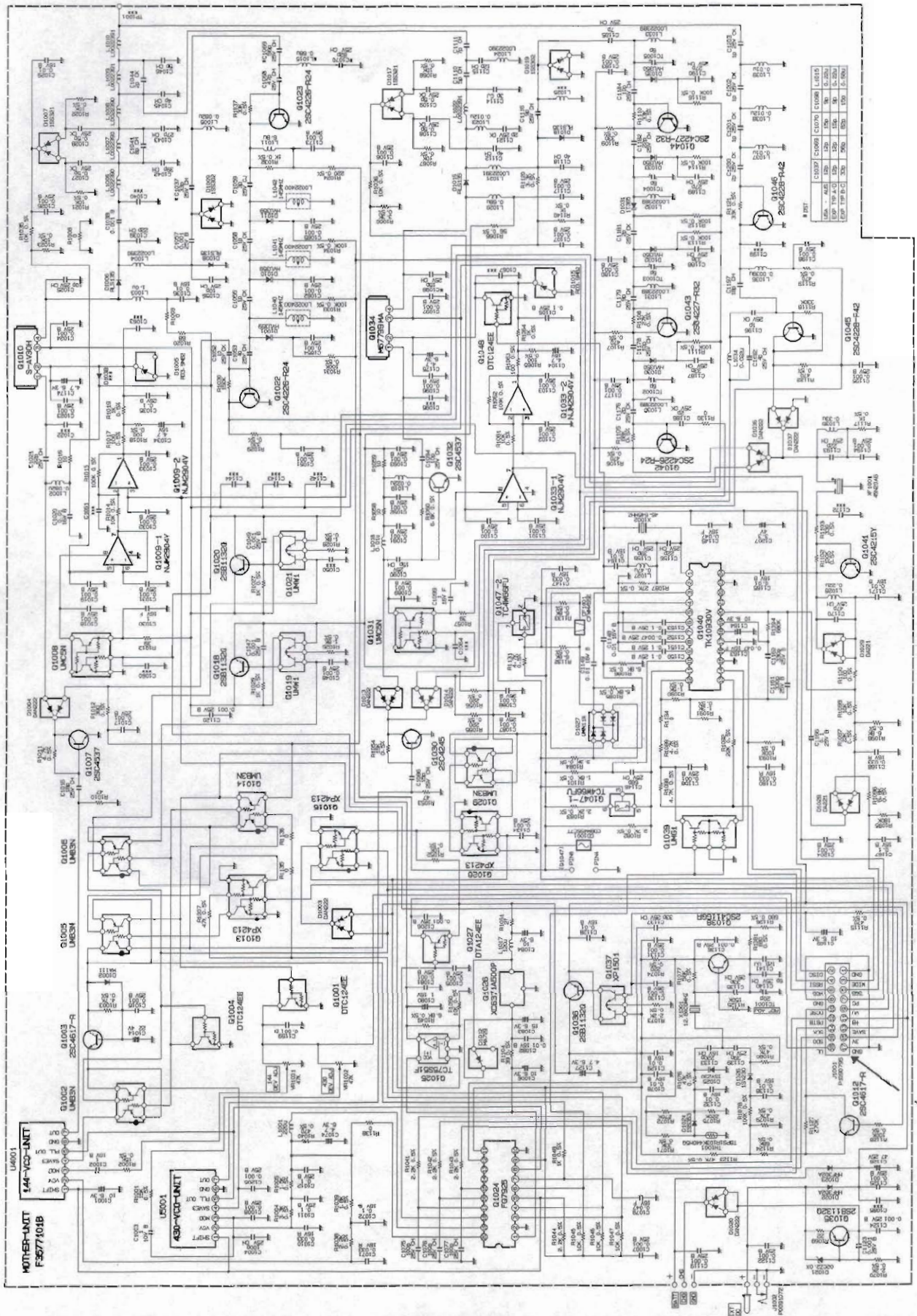

To CNTL Unit
(See Page 4D-1, 4D-1a)

MOTHER Unit (Lot. 5~)

Notes:

Parts Layout

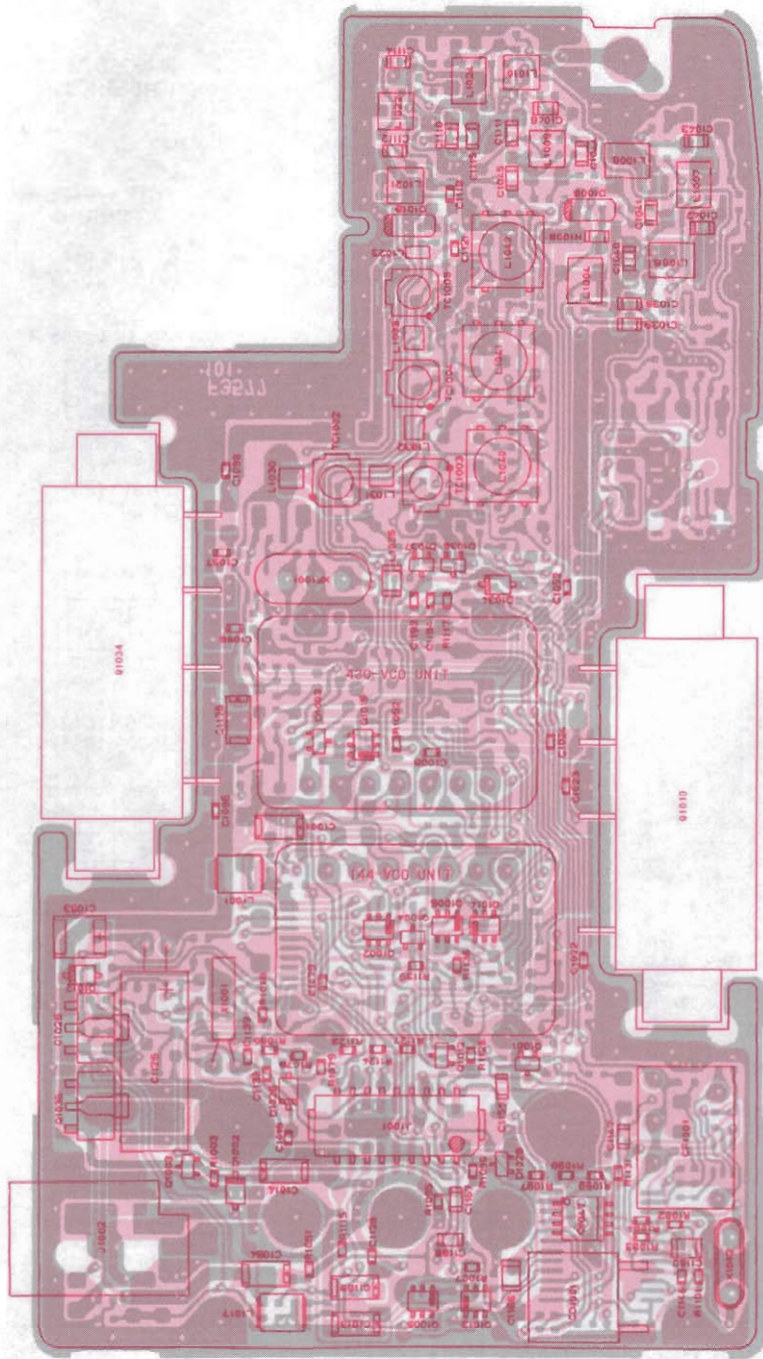

UL SDO SCK
 +B PSTB
 VU DCSE
 VC GND
 SCS MCO
 VCS RST
 GND DISC

To CNTL Unit J2001
 (See Page 5D-4)

Component Side

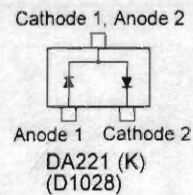
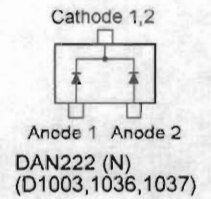
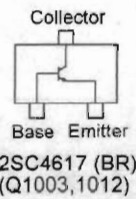
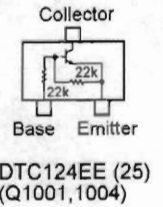
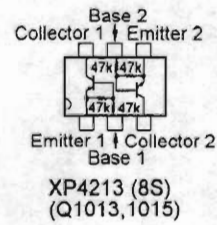
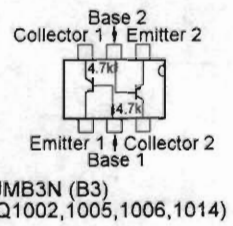
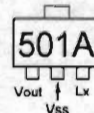
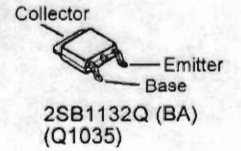
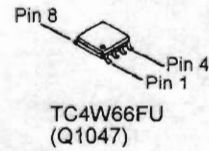
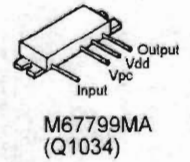
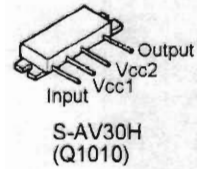

MOTHER Unit

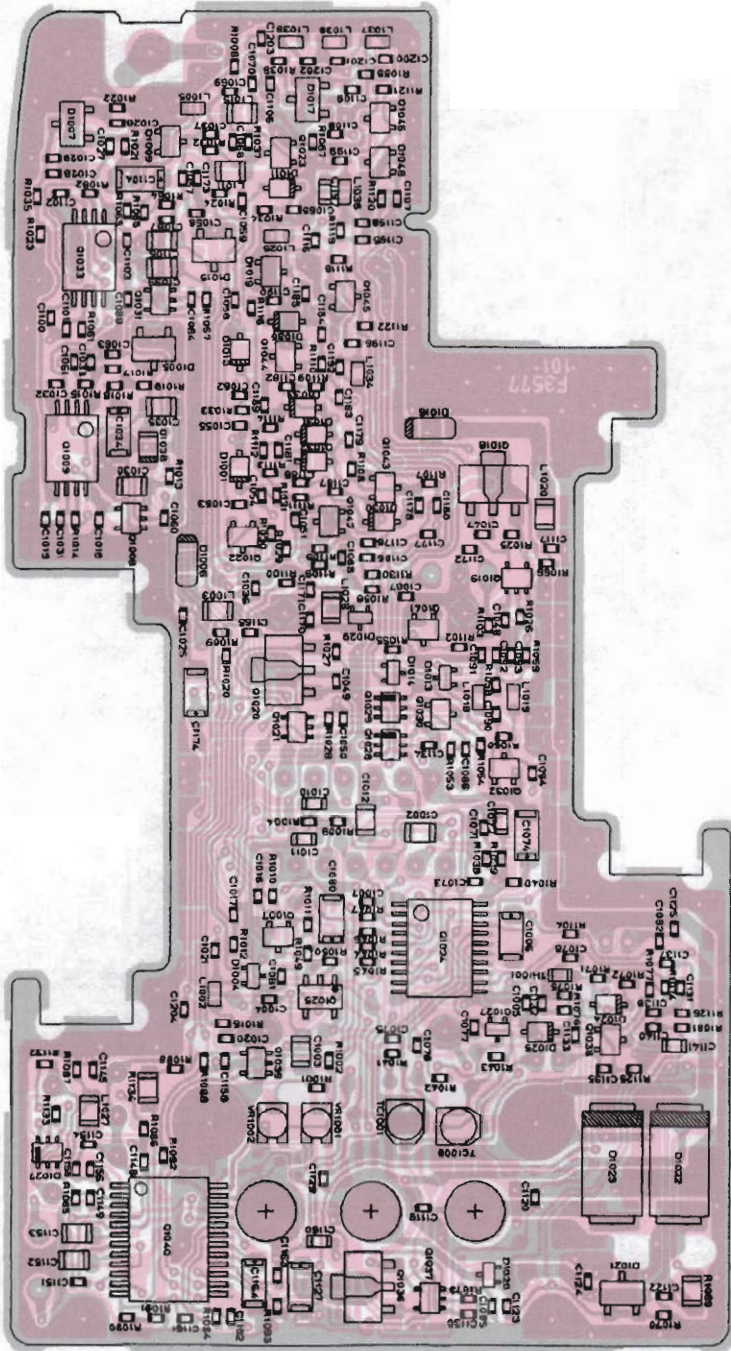

Chip Side

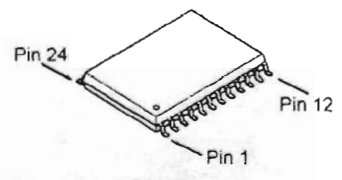
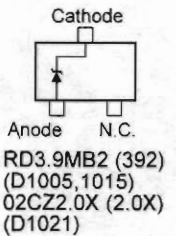
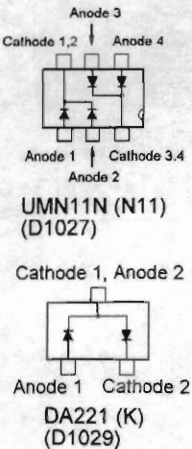
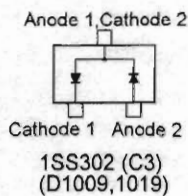
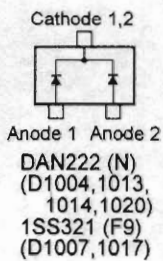

TK10930V
(Q1040)

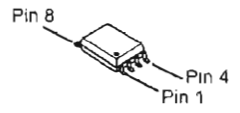

NJM2904V
(Q1009, 1033)

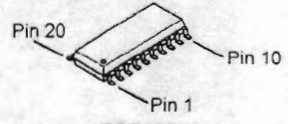

FQ7925
(Q1024)

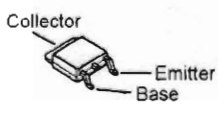

2SB1132Q (BA)
(Q1018, 1020, 1036)

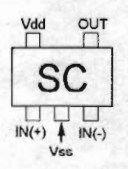

TC75S51F(SC)
(Q1025)

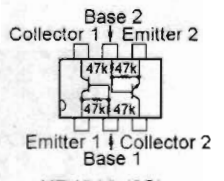

XP4213 (8S)
(Q1028)

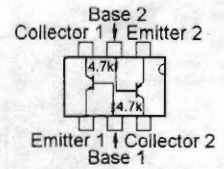

UMB3N (B3)
(Q1029)

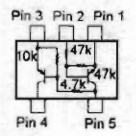

UMC5N (C5)
(Q1008, 1031)

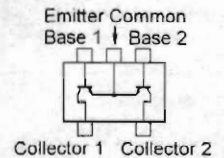

UMW1 (W1)
(Q1019, 1021)
XP1501 (5R)
(Q1037)

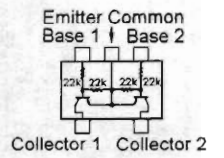

UMG1 (G1)
(Q1039)

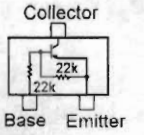

DTA124EE (15)
(Q1027)

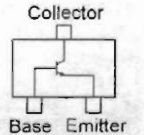

2SC4537 (IS-)
(Q1007, 1032)
2SC4226 (R22)
(Q1022, 1023, 1042)
2SC4227 (R32)
(Q1043, 1044)
2SC4245 (HB)
(Q1030)
2SC4116GR (LG)
(Q1038)
2SC4215Y (QY)
(Q1041)
2SC4228 (R42)
(Q1045, 1046)

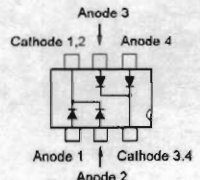

UMN11N (N11)
(D1027)

Parts Layout

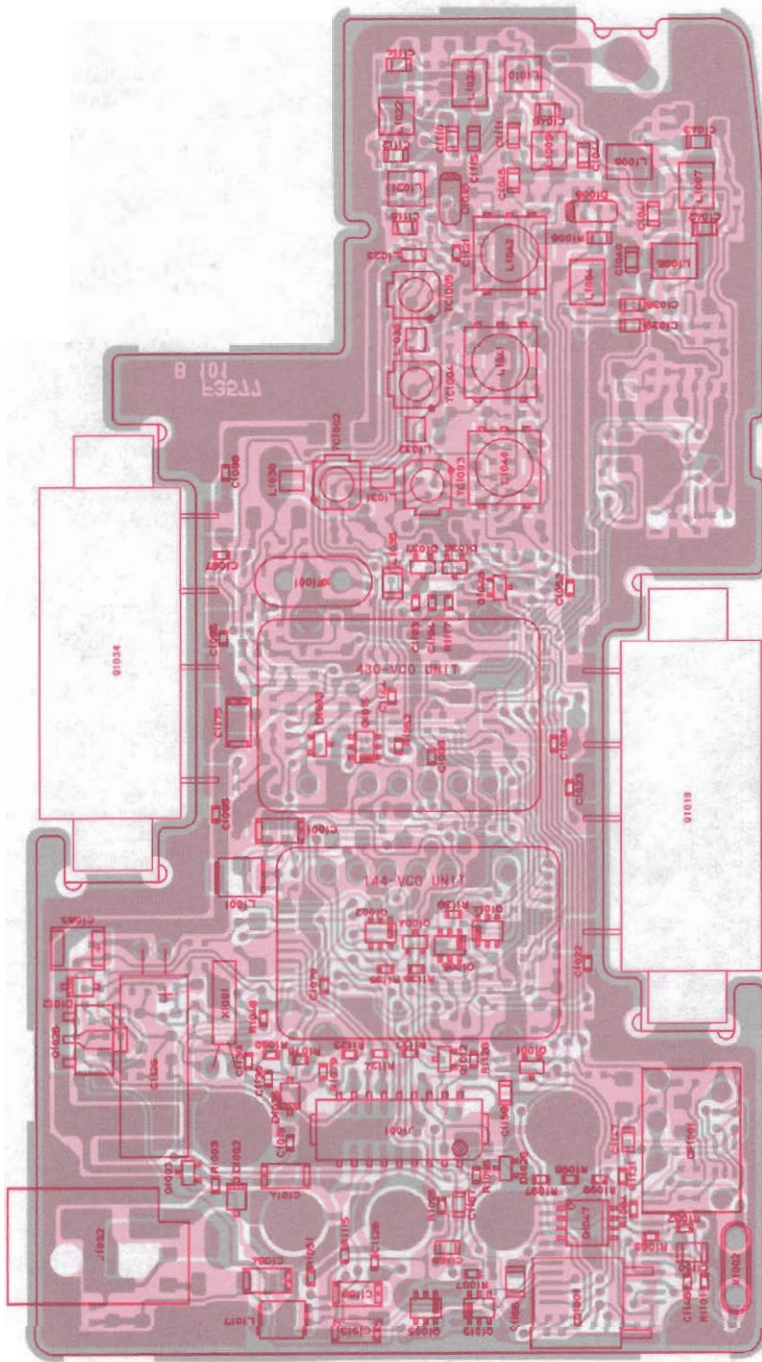

UL	SOC
3V	SK
SAVE	PCSE
4E	VJ
GND	PC
5	S3S
MOD	WIDE
RSS	GND
DISC	DISC

To CNTL Unit J2001
(See Page 5D-4, 5D-4a)

Component Side

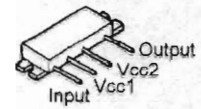

S-AV30H
(Q1010)

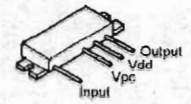

M67799MA
(Q1034)



TC4W66FU
(Q1047)

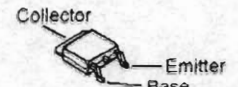

2SB1132Q (BA)
(Q1035)



XC6371A500PR (AF0)
(Q1026)

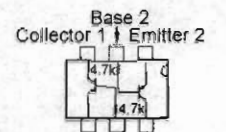

UMB3N (B3)
(Q1002, 1005, 1006, 1014)

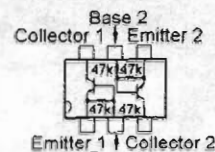

XP4213 (8S)
(Q1013, 1015)

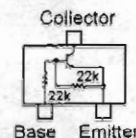

DTC124EE (2E)
(Q1001, 1004, 1048)

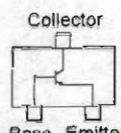

2SC4617 (BR)
(Q1003, 1012)

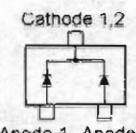

DAN222 (N)
(D1003, 1036, 1037)

Cathode 1, Anode 2

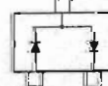

DA221 (K)
(D1028)

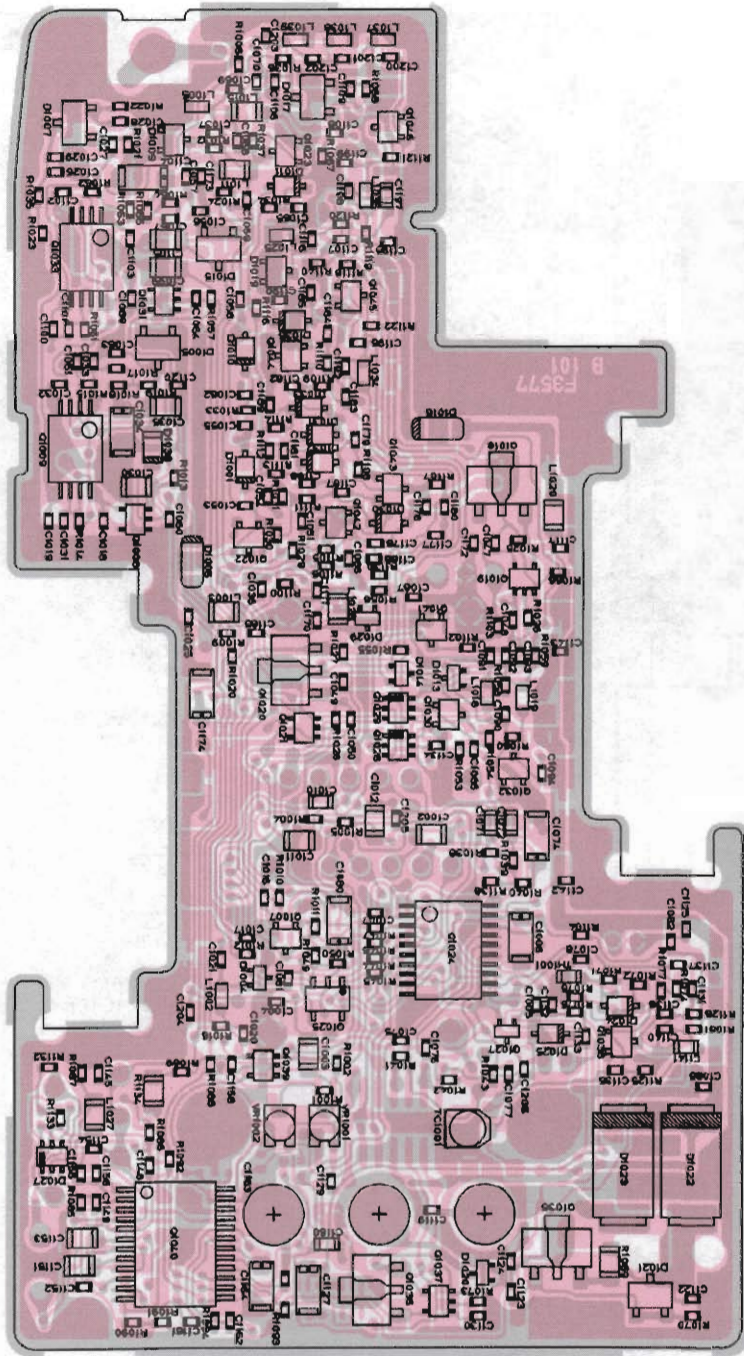

Chip Side

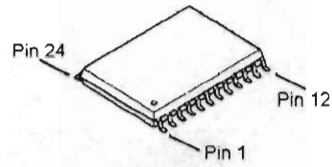

TK10930V (Q1040)

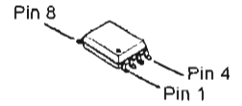

NJM2904V (Q1009,1033)

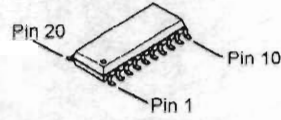

FQ7925 (Q1024)

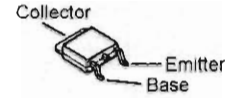

2SB1132Q (BA) (Q1018,1020,1036)

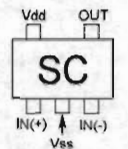

TC75S51F(SC) (Q1025)

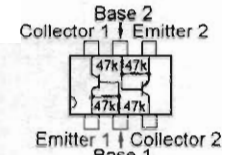

XP4213 (8S) (Q1028)

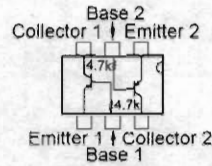

UMB3N (B3) (Q1029)

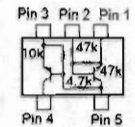

UMC5N (C5) (Q1008,1031)

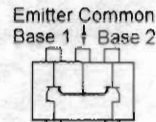

UMW1 (W1) (Q1019,1021)
XP1501 (5R) (Q1037)

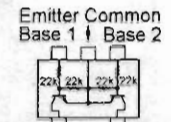

UMG1 (G1) (Q1039)

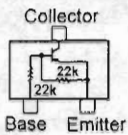

DTA124EE (15) (Q1027)

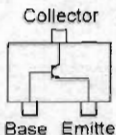

2SC4537 (IS-) (Q1007,1032)
2SC4226 (R22) (Q1022,1023,1042)
2SC4227 (R32) (Q1043,1044)
2SC4245 (HB) (Q1030)
2SC4116GR (LG) (Q1038)
2SC4215Y (QY) (Q1041)
2SC4228 (R42) (Q1045,1046)

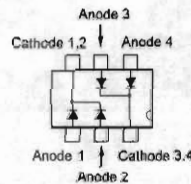

UMN11N (N11) (D1027)

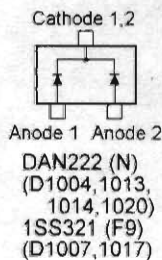

DAN222 (N) (D1004,1013,1014,1020)
1SS321 (F9) (D1007,1017)

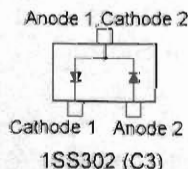

1SS302 (C3) (D1009,1019)

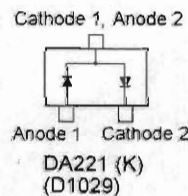

DA221 (K) (D1029)

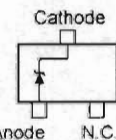

RD3.9MB2 (392) (D1005,1015)
02CZ2.0X (2.0X) (D1021)

Parts List

REF.	DESCRIPTION	VALUE	WV	TOL.	MFRGR'S DESIG	YAESU P/N	VERS.	LOT.	LAY ADR
*** MOTHER UNIT ***									
	PCB with Components	(w/ 144-VCO, 430-VCO UNIT)				CP5516002	DST USA, A2		
	PCB with Components	(w/ 144-VCO, 430-VCO UNIT)				CP5516003	DST EXP		-9
	PCB with Components	(w/ 144-VCO, 430-VCO UNIT)				CP5516004	DST AUS		-9
	PCB with Components	(w/ 144-VCO, 430-VCO UNIT)				CP5516005	DST EXP, A1		10-
	PCB with Components	(w/ 144-VCO, 430-VCO UNIT)				CP5516006	DST EXP, A2		10-
	PCB with Components	(w/ 144-VCO, 430-VCO UNIT)				CP5516007	DST EXP, A3		10-
	PCB with Components	(w/ 144-VCO, 430-VCO UNIT)				CP5516008	DST EXP, B1		10-
	PCB with Components	(w/ 144-VCO, 430-VCO UNIT)				CP5516009	DST EXP, B2		10-
	PCB with Components	(w/ 144-VCO, 430-VCO UNIT)				CP5516010	DST EXP, B3		10-
	PCB with Components	(w/ 144-VCO, 430-VCO UNIT)				CP5516011	DST EXP, C1		10-
	PCB with Components	(w/ 144-VCO, 430-VCO UNIT)				CP5516012	DST EXP, C2		10
	PCB with Components	(w/ 144-VCO, 430-VCO UNIT)				CP5516013	DST EXP, C3		10-
	PCB with Components	(w/ 144-VCO, 430-VCO UNIT)				CP5516014	DST EXP, D1		10-
	PCB with Components	(w/ 144-VCO, 430-VCO UNIT)				CP5516015	DST EXP, D2		10-
	PCB with Components	(w/ 144-VCO, 430-VCO UNIT)				CP5516016	DST AUS, H1		10-
	PCB with Components	(w/ 144-VCO, 430-VCO UNIT)				CP5516017	DST AUS, H2		10-
	Printed Circuit Board					F3577101			
	Printed Circuit Board					F3577101B			5-
C 1001	TANTALUM CHIP CAP.	10uF	6.3V		TEMSVA0J106M-8R	K78080027			
C 1002	CHIP CAP.	1uF	10V	B	GRM40B105K10PT	K22100802			
C 1003	CHIP CAP.	1uF	10V	B	GRM40B105K10PT	K22100802			
C 1004	CHIP CAP.	100pF	25V	CH	TMK105CH101J-F	K22148238			
C 1005	CHIP CAP.	0.001uF	25V	B	TMK105B102K-F	K22148820			
C 1006	TANTALUM CHIP CAP.	10uF	6.3V		TEMSVA0J106M-8R	K78080027			
C 1007	CHIP CAP.	0.001uF	25V	B	TMK105B102K-F	K22148820			
C 1008	CHIP CAP.	0.001uF	25V	B	TMK105B102K-F	K22148820			
C 1010	CHIP CAP.	0.033uF	16V	R	GRM39R333K16PT	K22124801			
C 1011	CHIP CAP.	0.033uF	16V	R	GRM39R333K16PT	K22124801			
C 1012	CHIP CAP.	0.1uF	25V	B	GRM40B104M25PT	K22140811			
C 1013	TANTALUM CHIP CAP.	4.7uF	6.3V		TEMSVA0J475M-8R	K78080017			
C 1014	TANTALUM CHIP CAP.	10uF	6.3V		TEMSVA0J106M-8R	K78080027			
C 1014	TANTALUM CHIP CAP.	22uF	4V		TEMSVA0G226M-8R	K78060023			18-
C 1015	CHIP CAP.	0.001uF	25V	B	TMK105B102K-F	K22148820			
C 1016	CHIP CAP.	18pF	25V	CH	TMK105CH180J-F	K22148220			
C 1017	CHIP CAP.	0.001uF	25V	B	TMK105B102K-F	K22148820			
C 1018	CHIP CAP.	0.001uF	25V	B	TMK105B102K-F	K22148820			
C 1019	CHIP CAP.	0.001uF	25V	B	TMK105B102K-F	K22148820			
C 1020	CHIP CAP.	0.01uF	16V	B	EMK105B103K-F	K22128802			
C 1021	CHIP CAP.	22pF	25V	CH	TMK105CH220J-F	K22148222			
C 1023	CHIP CAP.	0.001uF	25V	B	TMK105B102K-F	K22148820			
C 1024	CHIP CAP.	0.001uF	25V	B	TMK105B102K-F	K22148820			
C 1025	CHIP CAP.	10pF	25V	CH	TMK105CH100D-F	K22148214			
C 1026	CHIP CAP.	0.001uF	25V	B	TMK105B102K-F	K22148820			
C 1027	CHIP CAP.	0.5pF	25V	CK	TMK105CK0R5C-F	K22148204			
C 1028	CHIP CAP.	0.5pF	25V	CK	TMK105CK0R5C-F	K22148204			
C 1029	CHIP CAP.	0.01uF	16V	B	EMK105B103K-F	K22128802			
C 1030	CHIP CAP.	1uF	16V	F	EMK212F105Z00T	K22121001			
C 1031	CHIP CAP.	0.001uF	25V	B	TMK105B102K-F	K22148820			
C 1032	CHIP CAP.	0.001uF	25V	B	TMK105B102K-F	K22148820			
C 1033	CHIP CAP.	0.001uF	25V	B	TMK105B102K-F	K22148820			
C 1034	TANTALUM CHIP CAP.	4.7uF	16V		TEMSVA1C475M-8R	K78120031			
C 1035	CHIP CAP.	0.1uF	25V	B	GRM40B104M25PT	K22140811			
C 1036	CHIP CAP.	0.01uF	16V	B	EMK105B103K-F	K22128802			
C 1037	CHIP CAP.	33pF	25V	CH	TMK105CH330J-F	K22148226	DST AUS		
C 1037	CHIP CAP.	12pF	25V	CH	TMK105CH120J-F	K22148216	DST AUS		2-
C 1037	CHIP CAP.	33pF	25V	CH	TMK105CH330J-F	K22148226	DST EXP		
C 1037	CHIP CAP.	12pF	25V	CH	TMK105CH120J-F	K22148216	DST EXP		2-
C 1037	CHIP CAP.	12pF	25V	CH	TMK105CH120J-F	K22148216	TYP A1, EXP		10-
C 1037	CHIP CAP.	12pF	25V	CH	TMK105CH120J-F	K22148216	TYP A2, EXP		10-
C 1037	CHIP CAP.	12pF	25V	CH	TMK105CH120J-F	K22148216	TYP A3, EXP		10-

MOTHER Unit

REF.	DESCRIPTION	VALUE	WV	TOL.	MFGR'S DESIG	YAESU P/N	VERS.	LOT.	LAY ADR
C 1037	CHIP CAP.	33pF	25V	CH	TMK105CH330J-F	K22148226	TYP B1, EXP	10-	
C 1037	CHIP CAP.	33pF	25V	CH	TMK105CH330J-F	K22148226	TYP B2, EXP	10-	
C 1037	CHIP CAP.	33pF	25V	CH	TMK105CH330J-F	K22148226	TYP B3, EXP	10-	
C 1037	CHIP CAP.	33pF	25V	CH	TMK105CH330J-F	K22148226	TYP C1, EXP	10-	
C 1037	CHIP CAP.	33pF	25V	CH	TMK105CH330J-F	K22148226	TYP C2, EXP	10-	
C 1037	CHIP CAP.	33pF	25V	CH	TMK105CH330J-F	K22148226	TYP C3, EXP	10-	
C 1037	CHIP CAP.	12pF	25V	CH	TMK105CH120J-F	K22148216	TYP D1, EXP	10-	
C 1037	CHIP CAP.	12pF	25V	CH	TMK105CH120J-F	K22148216	TYP D2, EXP	10-	
C 1037	CHIP CAP.	33pF	25V	CH	TMK105CH330J-F	K22148226	DST USA		
C 1037	CHIP CAP.	12pF	25V	CH	TMK105CH120J-F	K22148216	DST USA	2-	
C 1038	CHIP CAP.	0.001uF	50V	B	GRM39B102K50PT	K22174821			
C 1039	CHIP CAP.	22pF	50V	CH	GRM39CH220J50PT	K22174219			
C 1039	CHIP CAP.	4pF	50V	CH	GRM39CH040C50PT	K22174205		2-	
C 1040	CHIP CAP.	18pF	50V	CH	GRM39CH180J50PT	K22174217		2-	
C 1041	CHIP CAP.	9pF	50V	CH	GRM39CH090D50PT	K22174210			
C 1041	CHIP CAP.	8pF	50V	CH	GRM39CH080D50PT	K22174209		5-	
C 1042	CHIP CAP.	33pF	50V	CH	GRM39CH330J50PT	K22174223			
C 1042	CHIP CAP.	39pF	50V	CH	GRM39CH390J50PT	K22174225		5-	
C 1043	CHIP CAP.	22pF	50V	CH	GRM39CH220J50PT	K22174219			
C 1043	CHIP CAP.	27pF	50V	CH	GRM39CH270J50PT	K22174221		5-	
C 1044	CHIP CAP.	2pF	50V	CK	GRM39CK020C50PT	K22174203			
C 1045	CHIP CAP.	4pF	50V	CH	GRM39CH040C50PT	K22174205			
C 1046	CHIP CAP.	5pF	50V	CH	GRM39CH050C50PT	K22174206			
C 1047	CHIP CAP.	0.001uF	25V	B	TMK105B102K-F	K22148820			
C 1048	CHIP CAP.	0.001uF	25V	B	TMK105B102K-F	K22148820			
C 1049	CHIP CAP.	0.001uF	25V	B	TMK105B102K-F	K22148820			
C 1051	CHIP CAP.	0.001uF	25V	B	TMK105B102K-F	K22148820			
C 1052	CHIP CAP.	1pF	25V	CK	TMK105CK010C-F	K22148205			
C 1053	CHIP CAP.	8pF	25V	CH	TMK105CH080D-F	K22148212			
C 1053	CHIP CAP.	4pF	25V	CH	TMK105CH040C-F	K22148208		2-	
C 1054	CHIP CAP.	0.001uF	25V	B	TMK105B102K-F	K22148820			
C 1055	CHIP CAP.	1pF	25V	CK	TMK105CK010C-F	K22148205			
C 1056	CHIP CAP.	10pF	25V	CH	TMK105CH100D-F	K22148214		5-	
C 1057	CHIP CAP.	0.001uF	25V	B	TMK105B102K-F	K22148820			
C 1058	CHIP CAP.	1pF	25V	CK	TMK105CK010C-F	K22148205			
C 1059	CHIP CAP.	3pF	25V	CJ	TMK105CJ030C-F	K22148207			
C 1062	CHIP CAP.	0.001uF	25V	B	TMK105B102K-F	K22148820			
C 1065	CHIP CAP.	0.001uF	25V	B	TMK105B102K-F	K22148820			
C 1068	CHIP CAP.	47pF	25V	CH	TMK105CH470J-F	K22148230			
C 1069	CHIP CAP.	56pF	25V	CH	TMK105CH560J-F	K22148232	DST AUS		
C 1069	CHIP CAP.	12pF	25V	CH	TMK105CH120J-F	K22148216	DST AUS	2-	
C 1069	CHIP CAP.	56pF	25V	CH	TMK105CH560J-F	K22148232	DST EXP		
C 1069	CHIP CAP.	12pF	25V	CH	TMK105CH120J-F	K22148216	DST EXP	2-	
C 1069	CHIP CAP.	12pF	25V	CH	TMK105CH120J-F	K22148216	TYP A1, EXP	10-	
C 1069	CHIP CAP.	12pF	25V	CH	TMK105CH120J-F	K22148216	TYP A2, EXP	10-	
C 1069	CHIP CAP.	12pF	25V	CH	TMK105CH120J-F	K22148216	TYP A3, EXP	10-	
C 1069	CHIP CAP.	56pF	25V	CH	TMK105CH560J-F	K22148232	TYP B1, EXP	10-	
C 1069	CHIP CAP.	56pF	25V	CH	TMK105CH560J-F	K22148232	TYP B2, EXP	10-	
C 1069	CHIP CAP.	56pF	25V	CH	TMK105CH560J-F	K22148232	TYP B3, EXP	10-	
C 1069	CHIP CAP.	56pF	25V	CH	TMK105CH560J-F	K22148232	TYP C1, EXP	10-	
C 1069	CHIP CAP.	56pF	25V	CH	TMK105CH560J-F	K22148232	TYP C2, EXP	10-	
C 1069	CHIP CAP.	56pF	25V	CH	TMK105CH560J-F	K22148232	TYP C3, EXP	10-	
C 1069	CHIP CAP.	12pF	25V	CH	TMK105CH120J-F	K22148216	TYP D1, EXP	10-	
C 1069	CHIP CAP.	12pF	25V	CH	TMK105CH120J-F	K22148216	TYP D2, EXP	10-	
C 1069	CHIP CAP.	56pF	25V	CH	TMK105CH560J-F	K22148232	DST USA		
C 1069	CHIP CAP.	12pF	25V	CH	TMK105CH120J-F	K22148216	DST USA	2-	
C 1070	CHIP CAP.	82pF	25V	CH	TMK105CH820J-F	K22148236	DST AUS		
C 1070	CHIP CAP.	15pF	25V	CH	TMK105CH150J-F	K22148218	DST AUS	2-	
C 1070	CHIP CAP.	82pF	25V	CH	TMK105CH820J-F	K22148236	DST EXP		
C 1070	CHIP CAP.	15pF	25V	CH	TMK105CH150J-F	K22148218	DST EXP	2-	
C 1070	CHIP CAP.	15pF	25V	CH	TMK105CH150J-F	K22148218	TYP A1, EXP	10-	

REF.	DESCRIPTION	VALUE	WV	TOL.	MFGR'S DESIG	YAESU P/N	VERS.	LOT.	LAY ADR
C 1070	CHIP CAP.	15pF	25V	CH	TMK105CH150J-F	K22148218	TYP A2, EXP	10-	
C 1070	CHIP CAP.	15pF	25V	CH	TMK105CH150J-F	K22148218	TYP A3, EXP	10-	
C 1070	CHIP CAP.	82pF	25V	CH	TMK105CH820J-F	K22148236	TYP B1, EXP	10-	
C 1070	CHIP CAP.	82pF	25V	CH	TMK105CH820J-F	K22148236	TYP B2, EXP	10-	
C 1070	CHIP CAP.	82pF	25V	CH	TMK105CH820J-F	K22148236	TYP B3, EXP	10-	
C 1070	CHIP CAP.	82pF	25V	CH	TMK105CH820J-F	K22148236	TYP C1, EXP	10-	
C 1070	CHIP CAP.	82pF	25V	CH	TMK105CH820J-F	K22148236	TYP C2, EXP	10-	
C 1070	CHIP CAP.	82pF	25V	CH	TMK105CH820J-F	K22148236	TYP C3, EXP	10-	
C 1070	CHIP CAP.	15pF	25V	CH	TMK105CH150J-F	K22148218	TYP D1, EXP	10-	
C 1070	CHIP CAP.	15pF	25V	CH	TMK105CH150J-F	K22148218	TYP D2, EXP	10-	
C 1070	CHIP CAP.	82pF	25V	CH	TMK105CH820J-F	K22148236	DST USA		
C 1070	CHIP CAP.	15pF	25V	CH	TMK105CH150J-F	K22148218	DST USA	2-	
C 1071	CHIP CAP.	0.01uF	16V	B	EMK105B103K-F	K22128802			
C 1071	CHIP CAP.	0.033uF	16V	R	GRM39R333K16PT	K22124801		5-	
C 1072	CHIP CAP.	0.047uF	16V	B	GRM39B473K16PT	K22124804			
C 1072	CHIP CAP.	0.1uF	16V	B	GRM39B104K16PT	K22124805		5-	
C 1074	TANTALUM CHIP CAP.	10uF	6.3V		TEMSVA0J106M-8R	K78080027			
C 1074	TANTALUM CHIP CAP.	4.7uF	6.3V		TEMSVA0J475M-8R	K78080017		5-	
C 1075	CHIP CAP.	100pF	25V	CH	TMK105CH101J-F	K22148238			
C 1076	CHIP CAP.	100pF	25V	CH	TMK105CH101J-F	K22148238			
C 1077	CHIP CAP.	100pF	25V	CH	TMK105CH101J-F	K22148238			
C 1078	CHIP CAP.	0.01uF	16V	B	EMK105B103K-F	K22128802			
C 1079	CHIP CAP.	0.047uF	16V	F	EMK105F473Z-F	K22129002			
C 1080	TANTALUM CHIP CAP.	1uF	16V		TESVA1C105M1-8R	K78120009			
C 1081	CHIP CAP.	0.001uF	25V	B	TMK105B102K-F	K22148820			
C 1082	CHIP CAP.	0.01uF	16V	B	EMK105B103K-F	K22128802			
C 1083	TANTALUM CHIP CAP.	15uF	6.3V		TEMSVB20J156M-8R	K78080023			
C 1084	TANTALUM CHIP CAP.	10uF	6.3V		TEMSVA0J106M-8R	K78080027			
C 1085	CHIP CAP.	0.01uF	16V	B	EMK105B103K-F	K22128802		-4	
C 1086	CHIP CAP.	15pF	25V	CH	TMK105CH150J-F	K22148218			
C 1087	CHIP CAP.	0.001uF	25V	B	TMK105B102K-F	K22148820			
C 1088	CHIP CAP.	0.001uF	25V	B	TMK105B102K-F	K22148820			
C 1089	CHIP CAP.	0.001uF	25V	B	TMK105B102K-F	K22148820			
C 1090	CHIP CAP.	15pF	25V	CH	TMK105CH150J-F	K22148218			
C 1091	CHIP CAP.	0.001uF	25V	B	TMK105B102K-F	K22148820			
C 1092	CHIP CAP.	0.001uF	25V	B	TMK105B102K-F	K22148820			
C 1093	CHIP CAP.	0.001uF	25V	B	TMK105B102K-F	K22148820			
C 1094	CHIP CAP.	3pF	25V	CJ	TMK105C1030C-F	K22148207			
C 1094	CHIP CAP.	10pF	25V	CH	TMK105CH100D-F	K22148214			
C 1096	CHIP CAP.	0.001uF	25V	B	TMK105B102K-F	K22148820			
C 1097	CHIP CAP.	0.001uF	25V	B	TMK105B102K-F	K22148820			
C 1098	CHIP CAP.	9pF	25V	CH	TMK105CH090D-F	K22148213			
C 1099	CHIP CAP.	1uF	16V	F	EMK212F105Z00T	K22121001			
C 1100	CHIP CAP.	0.001uF	25V	B	TMK105B102K-F	K22148820			
C 1101	CHIP CAP.	0.001uF	25V	B	TMK105B102K-F	K22148820			
C 1102	CHIP CAP.	0.001uF	25V	B	TMK105B102K-F	K22148820			
C 1103	CHIP CAP.	0.001uF	25V	B	TMK105B102K-F	K22148820			
C 1104	TANTALUM CHIP CAP.	4.7uF	16V		TEMSVA1C475M-8R	K78120031			
C 1105	CHIP CAP.	0.1uF	25V	B	GRM40B104M25PT	K22140811			
C 1106	CHIP CAP.	0.001uF	25V	B	TMK105B102K-F	K22148820			
C 1107	CHIP CAP.	0.001uF	25V	B	TMK105B102K-F	K22148820		5-	
C 1108	CHIP CAP.	0.5pF	25V	CK	TMK105CK0R5C-F	K22148204			
C 1109	CHIP CAP.	0.5pF	25V	CK	TMK105CK0R5C-F	K22148204			
C 1110	CHIP CAP.	4pF	50V	CH	GRM39CH040C50PT	K22174205			
C 1110	CHIP CAP.	5pF	50V	CH	GRM39CH050C50PT	K22174206		5-	
C 1111	CHIP CAP.	6pF	50V	CH	GRM39CH060D50PT	K22174207			
C 1111	CHIP CAP.	7pF	50V	CH	GRM39CH070D50PT	K22174208		5-	
C 1112	CHIP CAP.	4pF	50V	CH	GRM39CH040C50PT	K22174205			
C 1114	CHIP CAP.	3pF	50V	CJ	GRM39C1030C50PT	K22174204			
C 1115	CHIP CAP.	12pF	50V	CH	GRM39CH120J50PT	K22174213			
C 1116	CHIP CAP.	9pF	25V	CH	TMK105CH090D-F	K22148213			

MOTHER Unit

REF.	DESCRIPTION	VALUE	WV	TOL.	MFRG' S DESIG	YAESU P/N	VERS.	LOT.	LAY ADR
C 1117	CHIP CAP.	0.001uF	25V	B	TMK105B102K-F	K22148820			
C 1118	CHIP CAP.	5pF	25V	CH	TMK105CH050C-F	K22148209			
C 1118	CHIP CAP.	4pF	50V	CH	GRM39CH040C50PT	K22174205		5-	
C 1119	CHIP CAP.	0.001uF	25V	B	TMK105B102K-F	K22148820			
C 1120	CHIP CAP.	0.001uF	25V	B	TMK105B102K-F	K22148820			
C 1121	CHIP CAP.	2pF	25V	CK	TMK105CK020C-F	K22148206			
C 1122	CHIP CAP.	0.001uF	25V	B	TMK105B102K-F	K22148820			
C 1123	CHIP CAP.	0.001uF	25V	B	TMK105B102K-F	K22148820			
C 1124	CHIP CAP.	0.001uF	25V	B	TMK105B102K-F	K22148820			
C 1125	CHIP CAP.	0.001uF	25V	B	TMK105B102K-F	K22148820			
C 1126	AL. ELECTRO. CAP.	47uF	25V		UVR1E470MDA6	K40149046			
C 1127	TANTALUM CHIP CAP.	4.7uF	6.3V		TEMSVA0J475M-8R	K78080017			
C 1128	CHIP CAP.	0.01uF	16V	B	EMK105B103K-F	K22128802			
C 1129	CHIP CAP.	0.01uF	16V	B	EMK105B103K-F	K22128802		5-	
C 1130	CHIP CAP.	0.001uF	25V	B	TMK105B102K-F	K22148820			
C 1131	CHIP CAP.	0.001uF	25V	B	TMK105B102K-F	K22148820			
C 1132	CHIP CAP.	0.01uF	16V	B	EMK105B103K-F	K22128802			
C 1133	CHIP CAP.	220pF	16V	CH	EMK105CH221J-F	K22128208			
C 1134	CHIP CAP.	0.001uF	25V	B	TMK105B102K-F	K22148820			
C 1135	CHIP CAP.	33pF	25V	CH	TMK105CH330J-F	K22148226			
C 1136	CHIP CAP.	0.001uF	25V	B	TMK105B102K-F	K22148820			
C 1137	CHIP CAP.	33pF	25V	CH	TMK105CH330J-F	K22148226			
C 1138	CHIP CAP.	0.01uF	16V	B	EMK105B103K-F	K22128802			
C 1139	CHIP CAP.	39pF	25V	CH	TMK105CH390J-F	K22148228			
C 1140	CHIP CAP.	6pF	25V	CH	TMK105CH060D-F	K22148210			
C 1141	CHIP CAP.	12pF	50V	UJ	GRM39UJ120J50PT	K22174302			
C 1145	CHIP CAP.	0.047uF	16V	F	EMK105F473Z-F	K22129002			
C 1146	CHIP CAP.	68pF	25V	CH	TMK105CH680J-F	K22148234			
C 1147	CHIP CAP.	0.033uF	16V	R	GRM39R333K16PT	K22124801			
C 1148	CHIP CAP.	0.01uF	16V	B	EMK105B103K-F	K22128802			
C 1149	CHIP CAP.	0.01uF	16V	B	EMK105B103K-F	K22128802			
C 1150	CHIP CAP.	0.1uF	25V	B	GRM40B104M25PT	K22140811			
C 1151	CHIP CAP.	0.1uF	25V	B	GRM40B104M25PT	K22140811			
C 1152	CHIP CAP.	0.0047uF	25V	B	TMK105B472K-F	K22148801			
C 1153	CHIP CAP.	0.1uF	25V	B	GRM40B104M25PT	K22140811			
C 1154	CHIP CAP.	0.01uF	16V	B	EMK105B103K-F	K22128802			
C 1155	CHIP CAP.	39pF	25V	CH	TMK105CH390J-F	K22148228			
C 1156	CHIP CAP.	22pF	25V	CH	TMK105CH220J-F	K22148222			
C 1158	CHIP CAP.	0.001uF	25V	B	TMK105B102K-F	K22148820			
C 1159	CHIP CAP.	0.001uF	50V	B	GRM39B102K50PT	K22174821			
C 1160	CHIP CAP.	0.033uF	16V	R	GRM39R333K16PT	K22124801			
C 1161	CHIP CAP.	330pF	25V	B	TMK105B331K-F	K22148814			
C 1162	CHIP CAP.	330pF	25V	B	TMK105B331K-F	K22148814			
C 1163	CHIP CAP.	0.047uF	16V	F	EMK105F473Z-F	K22129002			
C 1164	TANTALUM CHIP CAP.	10uF	6.3V		TEMSVA0J106M-8R	K78080027			
C 1165	CHIP CAP.	0.01uF	16V	B	EMK105B103K-F	K22128802			
C 1166	CHIP CAP.	0.1uF	25V	B	GRM40B104M25PT	K22140811			
C 1167	CHIP CAP.	0.033uF	16V	R	GRM39R333K16PT	K22124801			
C 1167	CHIP CAP.	0.1uF	25V	F	GRM39F104Z25PT	K22145001		3-	
C 1167	CHIP CAP.	0.1uF	16V	B	GRM39B104K16PT	K22124805		4-	
C 1168	CHIP CAP.	0.033uF	16V	R	GRM39R333K16PT	K22124801			
C 1169	TANTALUM CHIP CAP.	10uF	6.3V		TEMSVA0J106M-8R	K78080027			
C 1170	CHIP CAP.	47pF	25V	CH	TMK105CH470J-F	K22148230			
C 1171	CHIP CAP.	0.01uF	16V	B	EMK105B103K-F	K22128802			
C 1173	CHIP CAP.	0.001uF	25V	B	TMK105B102K-F	K22148820			
C 1174	TANTALUM CHIP CAP.	4.7uF	6.3V		TEMSVA0J475M-8R	K78080017			
C 1175	TANTALUM CHIP CAP.	4.7uF	6.3V		TEMSVA0J475M-8R	K78080017			
C 1176	CHIP CAP.	3pF	25V	CJ	TMK105CJ030C-F	K22148207			
C 1176	CHIP CAP.	2pF	25V	CK	CM05CK2ROC50AH	K22178245		2-	
C 1176	CHIP CAP.	2pF	25V	CK	TMK105CK020C-F	K22148206		5-	
C 1177	CHIP CAP.	0.001uF	25V	B	TMK105B102K-F	K22148820			

REF.	DESCRIPTION	VALUE	WV	TOL.	MFGR'S DESIG	YAESU P/N	VERS.	LOT.	LAY ADR
C 1178	CHIP CAP.	10pF	25V	CH	TMK105CH100D-F	K22148214			
C 1179	CHIP CAP.	9pF	25V	CH	TMK105CH090D-F	K22148213			
C 1180	CHIP CAP.	0.001uF	25V	B	TMK105B102K-F	K22148820			
C 1181	CHIP CAP.	1pF	25V	CK	TMK105CK010C-F	K22148205			
C 1181	CHIP CAP.	2pF	25V	CK	TMK105CK020C-F	K22148206		5-	
C 1182	CHIP CAP.	22pF	25V	CH	TMK105CH220J-F	K22148222			
C 1183	CHIP CAP.	0.001uF	25V	B	TMK105B102K-F	K22148820			
C 1184	CHIP CAP.	27pF	25V	CH	TMK105CH270J-F	K22148224			
C 1184	CHIP CAP.	10pF	25V	CH	TMK105CH100J-F	K22148214		5-	
C 1185	CHIP CAP.	7pF	25V	CH	TMK105CH070D-F	K22148211			
C 1186	CHIP CAP.	2pF	25V	CK	TMK105CK020C-F	K22148206			
C 1187	CHIP CAP.	33pF	25V	CH	TMK105CH330J-F	K22148226			
C 1188	CHIP CAP.	33pF	25V	CH	TMK105CH330J-F	K22148226			
C 1189	CHIP CAP.	27pF	25V	CH	TMK105CH270J-F	K22148224			
C 1190	CHIP CAP.	27pF	25V	CH	TMK105CH270J-F	K22148224			
C 1192	CHIP CAP.	4pF	25V	CH	TMK105CH040C-F	K22148208			
C 1193	CHIP CAP.	22pF	25V	CH	TMK105CH220J-F	K22148222			
C 1194	CHIP CAP.	0.001uF	25V	B	TMK105B102K-F	K22148820			
C 1195	CHIP CAP.	0.001uF	25V	B	TMK105B102K-F	K22148820			
C 1196	CHIP CAP.	1pF	25V	CK	TMK105CK010C-F	K22148205			
C 1197	CHIP CAP.	18pF	50V	CH	GRM39CH180J50PT	K22174217			
C 1198	CHIP CAP.	0.001uF	25V	B	TMK105B102K-F	K22148820			
C 1200	CHIP CAP.	2pF	25V	CK	TMK105CK020C-F	K22148206			
C 1201	CHIP CAP.	1pF	25V	CK	TMK105CK010C-F	K22148205			
C 1202	CHIP CAP.	1pF	25V	CK	TMK105CK010C-F	K22148205			
C 1203	CHIP CAP.	1pF	25V	CK	TMK105CK010C-F	K22148205			
C 1204	CHIP CAP.	0.001uF	25V	B	TMK105B102K-F	K22148820			
C 1205	CHIP CAP.	0.001uF	50V	B	GRM39B102K50PT	K22174821			
C 1205	CHIP CAP.	0.001uF	25V	B	TMK105B102K-F	K22148820		5-	
C 1206	CHIP CAP.	0.001uF	50V	B	GRM39B102K50PT	K22174821			
C 1206	CHIP CAP.	0.001uF	25V	B	TMK105B102K-F	K22148820		5-	
C 1207	TANTALUM CHIP CAP.	3.3uF	4V		TESVSP0G335M-8R	K78060032		5-	
CD1001	CERAMIC DISC				CDBM455C7T	H7900910			
CF1001	CERAMIC FILTER				MCFH455ELM01	H3900458			
CF1001	CERAMIC FILTER				CFWM455E	H3900400		23-	
D 1001	DIODE				HVU359TRF	G2070452			
D 1002	DIODE				MA111- (TX)	G2070338			
D 1003	DIODE				DAN222 TL	G2070174			
D 1004	DIODE				DAN222 TL	G2070174			
D 1005	DIODE				RD3.9MB2-T2B	G2070106			
D 1006	DIODE				RLS135 TE-11	G2070128			
D 1007	DIODE				1SS321 TE85R	G2070076			
D 1008	DIODE				RLS135 TE-11	G2070128			
D 1009	DIODE				1SS302 TE85R	G2070088			
D 1010	DIODE				HVU359TRF	G2070452			
D 1011	DIODE				HVU359TRF	G2070452			
D 1012	DIODE				MA729- (TX)	G2070320			
D 1013	DIODE				DAN222 TL	G2070174			
D 1014	DIODE				DAN222 TL	G2070174			
D 1015	DIODE				RD3.9MB2-T2B	G2070106			
D 1016	DIODE				RLS135 TE-11	G2070128			
D 1017	DIODE				1SS321 TE85R	G2070076			
D 1018	DIODE				RLS135 TE-11	G2070128			
D 1019	DIODE				1SS302 TE85R	G2070088			
D 1020	DIODE				DAN222 TL	G2070174			
D 1021	DIODE				O2CZ2.0X TE85R	G2070124			
D 1022	DIODE				HRF302ATR	G2070407			
D 1023	DIODE				HRF302ATR	G2070407			
D 1024	DIODE				1SS353 TE-17	G2070394			
D 1025	DIODE				1SV230 TPH3	G2070126			
D 1026	DIODE				1SV230 TPH3	G2070126			

MOTHER Unit

REF.	DESCRIPTION	VALUE	WV	TOL.	MFGR'S DESIG	YAESU P/N	VERS.	LOT.	LAY ADR
D 1027	DIODE				UMN11 TN	G2070198			
D 1028	DIODE				DA221 TL	G2070178			
D 1029	DIODE				DA221 TL	G2070178			
D 1030	DIODE				HVU350-TR	G2070380			
D 1031	DIODE				1T365-01-T8A	G2070416			
D 1032	DIODE				HVU350-TR	G2070380			
D 1033	DIODE				HVU350-TR	G2070380			
D 1034	DIODE				MA111- (TX)	G2070338			-4
D 1035	DIODE				HVU350-TR	G2070380			
D 1036	DIODE				DAN222 TL	G2070174			
D 1037	DIODE				DAN222 TL	G2070174			
J 1001	CONNECTOR				CPB8518-0151	P1090795			
J 1002	CONNECTOR				LGP3131-0111	P0091072			
L 1001	M. RFC	220uH			FLC32T-221J	L1690231			
L 1002	M. RFC	0.082uH			LL1608-F82NK	L1690462			
L 1002	M. RFC	0.082uH			LL1608 82NJ-T	L1690527		21-	
L 1003	M. RFC	1.0uH			LK2125 1R0K-T	L1690319			
L 1004	COIL				E2 0.35-1.6-7T-L	L0022390			
L 1005	M. RFC	0.082uH			LL1608-F82NK	L1690462			
L 1005	M. RFC	0.082uH			LL1608 82NJ-T	L1690527		21-	
L 1006	COIL				E2 0.35-1.6-7T-L	L0022390			
L 1007	COIL				E2 0.35-1.6-7T-L	L0022390			
L 1008	COIL				E2 0.35-1.6-7T-L	L0022390			
L 1009	COIL				E2 0.45-1.4-4T-L	L0022391			
L 1010	COIL				E2 0.45-1.4-4T-L	L0022391			
L 1011	M. RFC	6.8uH			LK2125 6R8K-T	L1690329			
L 1015	M. RFC	0.68uH			LK2125 R68K-T	L1690317	DST AUS		
L 1015	M. RFC	0.22uH			LK2125 R22K-T	L1690311	DST AUS	2-	
L 1015	M. RFC	0.68uH			LK2125 R68K-T	L1690317	DST EXP		
L 1015	M. RFC	0.22uH			LK2125 R22K-T	L1690311	DST EXP	2-	
L 1015	M. RFC	0.22uH			LK2125 R22K-T	L1690311	TYP A1, EXP	10-	
L 1015	M. RFC	0.22uH			LK2125 R22K-T	L1690311	TYP A2, EXP	10-	
L 1015	M. RFC	0.22uH			LK2125 R22K-T	L1690311	TYP A3, EXP	10-	
L 1015	M. RFC	0.68uH			LK2125 R68K-T	L1690317	TYP B1, EXP	10-	
L 1015	M. RFC	0.68uH			LK2125 R68K-T	L1690317	TYP B2, EXP	10-	
L 1015	M. RFC	0.68uH			LK2125 R68K-T	L1690317	TYP B3, EXP	10-	
L 1015	M. RFC	0.68uH			LK2125 R68K-T	L1690317	TYP C1, EXP	10-	
L 1015	M. RFC	0.68uH			LK2125 R68K-T	L1690317	TYP C2, EXP	10-	
L 1015	M. RFC	0.68uH			LK2125 R68K-T	L1690317	TYP C3, EXP	10-	
L 1015	M. RFC	0.22uH			LK2125 R22K-T	L1690311	TYP D1, EXP	10-	
L 1015	M. RFC	0.22uH			LK2125 R22K-T	L1690311	TYP D2, EXP	10-	
L 1015	M. RFC	0.68uH			LK2125 R68K-T	L1690317	DST USA		
L 1015	M. RFC	0.22uH			LK2125 R22K-T	L1690311	DST USA	2-	
L 1017	M. RFC	120uH			FLC32T-121J	L1690228			
L 1018	M. RFC	0.01uH			TFL0816-10	L1690491			
L 1019	M. RFC	0.022uH			TFL0816-22	L1690495			
L 1020	M. RFC	0.68uH			LK2125 R68K-T	L1690317			
L 1021	COIL				E2 0.45-1.4-4T-L	L0022391			
L 1022	COIL				E2 0.45-1.4-4T-L	L0022391			
L 1023	M. RFC	0.012uH			TFL0816-12	L1690492			
L 1024	COIL				E2 0.35-1.6-7T-L	L0022390			
L 1027	M. RFC	0.47uH			LK2125 R47K-T	L1690315			
L 1028	M. RFC	0.22uH			LK2125 R22K-T	L1690311			
L 1030	COIL				E2 0.3-0.9-3T-R	L0022389			
L 1031	COIL				E2 0.3-0.9-3T-R	L0022389			
L 1032	COIL				E2 0.3-0.9-3T-R	L0022389			
L 1033	COIL				E2 0.3-0.9-3T-R	L0022389			
L 1034	M. RFC	0.022uH			TFL0816-22	L1690495			
L 1035	M. RFC	0.33uH			LK2125 R33K-T	L1690313			
L 1036	M. RFC	0.0039uH			TFL0816-3N9	L1690486			
L 1037	M. RFC	0.01uH			TFL0816-10	L1690491			

REF.	DESCRIPTION	VALUE	WV	TOL.	MFR'S DESIG	YAESU P/N	VERS.	LOT.	LAY ADR
L 1038	M. RFC	0.012uH			TFL0816-12	L1690492			
L 1039	M. RFC	0.01uH			TFL0816-10	L1690491			
L 1040	COIL	145MHZ			145M	L0022400			
L 1041	COIL	145MHZ			145M	L0022400			
L 1042	COIL	145MHZ			145M	L0022400			
Q 1001	TRANSISTOR				DTC124EE TL	G3070109			
Q 1002	TRANSISTOR				UMB3N TN	G3070158			
Q 1003	TRANSISTOR				2SC4617 TL R	G3346178R			
Q 1004	TRANSISTOR				DTC124EE TL	G3070109			
Q 1005	TRANSISTOR				UMB3N TN	G3070158			
Q 1006	TRANSISTOR				UMB3N TN	G3070158			
Q 1007	TRANSISTOR				2SC4537 TR	G3345377			
Q 1008	TRANSISTOR				UMC5N TL	G3070137			
Q 1009	IC				NJM2904V-TE1	G1091677			
Q 1010	IC				S-AV30H	G1092186			
Q 1012	TRANSISTOR				2SC4617 TL R	G3346178R			
Q 1013	TRANSISTOR				XP4213- (TX)	G3070140			
Q 1014	TRANSISTOR				UMB3N TN	G3070158			
Q 1015	TRANSISTOR				XP4213- (TX)	G3070140			
Q 1018	TRANSISTOR				2SB1132 T100 Q	G3211327Q			
Q 1019	TRANSISTOR				UMW1N TR	G3070078			
Q 1020	TRANSISTOR				2SB1132 T100 Q	G3211327Q			
Q 1021	TRANSISTOR				UMW1N TR	G3070078			
Q 1022	TRANSISTOR				2SC4226-T2B R24	G3342267D			
Q 1023	TRANSISTOR				2SC4226-T2B R24	G3342267D			
Q 1024	IC				FQ7925	G1091710			
Q 1025	IC				TC75S51F TE85R	G1092048			
Q 1026	IC				RH5RH501A-T1	G1091603			
Q 1026	IC				XC6371A500PR	G1092462		15-	
Q 1027	TRANSISTOR				DTA124EE TL	G3070116			
Q 1028	TRANSISTOR				XP4213- (TX)	G3070140			
Q 1029	TRANSISTOR				UMB3N TN	G3070158			
Q 1030	TRANSISTOR				2SC4245 TE85R	G3342457			
Q 1031	TRANSISTOR				UMC5N TL	G3070137			
Q 1032	TRANSISTOR				2SC4537 TR	G3345377			
Q 1033	IC				NJM2904V-TE1	G1091677			
Q 1034	IC				M67799MA-21	G1091938			
Q 1035	TRANSISTOR				2SB1132 T100 Q	G3211327Q			
Q 1036	TRANSISTOR				2SB1132 T100 Q	G3211327Q			
Q 1037	TRANSISTOR				XP1501- (TX)	G3070143			
Q 1038	TRANSISTOR				2SC4116GR TE85R	G3341167G			
Q 1039	TRANSISTOR				UMG1N TR	G3070113			
Q 1040	IC				TK10930VT1	G1091606			
Q 1041	TRANSISTOR				2SC4215Y TE85R	G3342157Y			
Q 1042	TRANSISTOR				2SC4226-T2B R24	G3342267D			
Q 1043	TRANSISTOR				2SC4227-T2 R32	G3342277B			
Q 1044	TRANSISTOR				2SC4227-T2 R32	G3342277B			
Q 1045	TRANSISTOR				2SC4228-T2B R42	G3342287B			
Q 1046	TRANSISTOR				2SC4228-T2B R42	G3342287B			
Q 1047	IC				TC4W66FU TE12L	G1091676			
Q 1048	TRANSISTOR				DTC124EE TL	G3070109		5-	
R 1001	CHIP RES.	15K	1/16W	0.5%	RR0510R-153-D	J24189147			
R 1002	CHIP RES.	15K	1/16W	0.5%	RR0510R-153-D	J24189147			
R 1003	CHIP RES.	4.7K	1/16W	0.5%	RR0510P-472-D	J24189135			
R 1004	CHIP RES.	3.3K	1/16W	0.5%	RR0510P-332-D	J24189131			
R 1005	CHIP RES.	2.2K	1/16W	0.5%	RR0510P-222-D	J24189127			
R 1005	CHIP RES.	1.5K	1/16W	0.5%	RR0510P-152-D	J24189123		5-	
R 1006	CHIP RES.	3.3K	1/16W	0.5%	RR0510P-332-D	J24189131			
R 1007	CHIP RES.	47K	1/16W	0.5%	RR0510R-473-D	J24189159			
R 1008	CHIP RES.	0	1/16W	5%	RMC1/16 000JATP	J24185000			
R 1009	CHIP RES.	0	1/16W	5%	RMC1/16S JPTH	J24189070			

MOTHER Unit

REF.	DESCRIPTION	VALUE	WV	TOL.	MFGR'S DESIG	YAESU P/N	VERS.	LOT.	LAY ADR
R 1010	CHIP RES.	47	1/16W	5%	RMC1/16S 470JTH	J24189009			
R 1011	CHIP RES.	4.7K	1/16W	0.5%	RR0510P-472-D	J24189135			
R 1012	CHIP RES.	390	1/16W	0.5%	RR0510P-391-D	J24189109			
R 1013	CHIP RES.	39	1/16W	5%	RMC1/16S 390JTH	J24189008			
R 1014	CHIP RES.	10K	1/16W	0.5%	RR0510P-103-D	J24189143			
R 1015	CHIP RES.	100K	1/16W	0.5%	RR0510R-104-D	J24189167			
R 1016	CHIP RES.	10	1/16W	5%	RMC1/16S 100JTH	J24189001			
R 1017	CHIP RES.	100	1/16W	0.5%	RR0510P-101-D	J24189095			
R 1018	CHIP RES.	100	1/16W	0.5%	RR0510P-101-D	J24189095			
R 1019	CHIP RES.	1K	1/16W	0.5%	RR0510P-102-D	J24189119			
R 1020	CHIP RES.	68	1/16W	5%	RMC1/16S 680JTH	J24189011			
R 1021	CHIP RES.	10K	1/16W	0.5%	RR0510P-103-D	J24189143			
R 1022	CHIP RES.	10K	1/16W	0.5%	RR0510P-103-D	J24189143			
R 1023	CHIP RES.	10K	1/16W	0.5%	RR0510P-103-D	J24189143			
R 1024	CHIP RES.	220	1/16W	0.5%	RR0510P-221-D	J24189103			
R 1025	CHIP RES.	1K	1/16W	0.5%	RR0510P-102-D	J24189119			
R 1026	CHIP RES.	1.8K	1/16W	0.5%	RR0510P-182-D	J24189125			
R 1027	CHIP RES.	1K	1/16W	0.5%	RR0510P-102-D	J24189119			
R 1028	CHIP RES.	1.8K	1/16W	0.5%	RR0510P-182-D	J24189125			
R 1029	CHIP RES.	330	1/16W	0.5%	RR0510P-331-D	J24189107			
R 1030	CHIP RES.	150K	1/16W	5%	RMC1/16S 154JTH	J24189051			
R 1031	CHIP RES.	100K	1/16W	0.5%	RR0510R-104-D	J24189167			
R 1032	CHIP RES.	1K	1/16W	0.5%	RR0510P-102-D	J24189119			
R 1033	CHIP RES.	100K	1/16W	0.5%	RR0510R-104-D	J24189167			
R 1034	CHIP RES.	100K	1/16W	0.5%	RR0510R-104-D	J24189167			
R 1035	CHIP RES.	10K	1/16W	0.5%	RR0510P-103-D	J24189143			
R 1036	CHIP RES.	10K	1/16W	0.5%	RR0510P-103-D	J24189143			
R 1037	CHIP RES.	33K	1/16W	0.5%	RR0510R-333-D	J24189155			
R 1038	CHIP RES.	10K	1/16W	0.5%	RR0510P-103-D	J24189143			
R 1038	CHIP RES.	2.2K	1/16W	0.5%	RR0510P-222-D	J24189127		5-	
R 1039	CHIP RES.	5.6K	1/16W	0.5%	RR0510P-562-D	J24189137			
R 1039	CHIP RES.	1.8K	1/16W	0.5%	RR0510P-182-D	J24189125		5-	
R 1040	CHIP RES.	330	1/16W	0.5%	RR0510P-331-D	J24189107			
R 1040	CHIP RES.	470	1/16W	0.5%	RR0510P-471-D	J24189111		5-	
R 1041	CHIP RES.	2.2K	1/16W	0.5%	RR0510P-222-D	J24189127			
R 1042	CHIP RES.	2.2K	1/16W	0.5%	RR0510P-222-D	J24189127			
R 1043	CHIP RES.	2.2K	1/16W	0.5%	RR0510P-222-D	J24189127			
R 1044	CHIP RES.	2.2K	1/16W	0.5%	RR0510P-222-D	J24189127			
R 1045	CHIP RES.	10K	1/16W	0.5%	RR0510P-103-D	J24189143			
R 1046	CHIP RES.	10K	1/16W	0.5%	RR0510P-103-D	J24189143			
R 1047	CHIP RES.	10K	1/16W	0.5%	RR0510P-103-D	J24189143			
R 1048	CHIP RES.	1K	1/16W	0.5%	RR0510P-102-D	J24189119			
R 1049	CHIP RES.	6.8K	1/16W	0.5%	RR0510P-682-D	J24189139			
R 1050	CHIP RES.	10K	1/16W	0.5%	RR0510P-103-D	J24189143			
R 1051	CHIP RES.	27	1/16W	5%	RMC1/16S 270JTH	J24189006			
R 1052	CHIP RES.	10K	1/16W	0.5%	RR0510P-103-D	J24189143			
R 1053	CHIP RES.	47	1/16W	5%	RMC1/16S 470JTH	J24189009			
R 1054	CHIP RES.	15K	1/16W	0.5%	RR0510R-153-D	J24189147			
R 1055	CHIP RES.	220	1/16W	0.5%	RR0510P-221-D	J24189103			
R 1056	CHIP RES.	220	1/16W	0.5%	RR0510P-221-D	J24189103			
R 1057	CHIP RES.	39	1/16W	5%	RMC1/16S 390JTH	J24189008			
R 1058	CHIP RES.	10	1/16W	5%	RMC1/16S 100JTH	J24189001			
R 1059	CHIP RES.	10	1/16W	5%	RMC1/16S 100JTH	J24189001			
R 1060	CHIP RES.	6.8K	1/16W	0.5%	RR0510P-682-D	J24189139			
R 1061	CHIP RES.	10K	1/16W	0.5%	RR0510P-103-D	J24189143			
R 1062	CHIP RES.	100K	1/16W	0.5%	RR0510R-104-D	J24189167			
R 1063	CHIP RES.	100	1/16W	0.5%	RR0510P-101-D	J24189095			
R 1064	CHIP RES.	1K	1/16W	0.5%	RR0510P-102-D	J24189119			
R 1065	CHIP RES.	100	1/16W	0.5%	RR0510P-101-D	J24189095			
R 1066	CHIP RES.	56	1/16W	0.5%	RR0510R-560-D	J24189089			
R 1067	CHIP RES.	10K	1/16W	0.5%	RR0510P-103-D	J24189143			

MOTHER Unit

REF.	DESCRIPTION	VALUE	WV	TOL.	MFGR' S DESIG	YAESU P/N	VERS.	LOT.	LAY ADR
R 1068	CHIP RES.	10K	1/16W	0.5%	RR0510P-103-D	J24189143			
R 1069	CHIP RES.	22	1/10W	5%	RMC1/10T 220J	J24205220			
R 1070	CHIP RES.	2.2K	1/16W	0.5%	RR0510P-222-D	J24189127			
R 1071	CHIP RES.	15K	1/16W	0.5%	RR0510R-153-D	J24189147			
R 1071	CHIP RES.	27K	1/16W	0.5%	RR0510R-273-D	J24189153		4-	
R 1072	CHIP RES.	270K	1/16W	5%	RMC1/16S 274JTH	J24189054			
R 1073	CHIP RES.	2.2K	1/16W	0.5%	RR0510P-222-D	J24189127			
R 1074	CHIP RES.	220	1/16W	0.5%	RR0510P-221-D	J24189103			
R 1075	CHIP RES.	220K	1/16W	5%	RMC1/16S 224JTH	J24189053			
R 1076	CHIP RES.	47K	1/16W	0.5%	RR0510R-473-D	J24189159			
R 1077	CHIP RES.	56K	1/16W	0.5%	RR0510R-563-D	J24189161			
R 1078	CHIP RES.	100K	1/16W	0.5%	RR0510R-104-D	J24189167			
R 1079	CHIP RES.	47K	1/16W	0.5%	RR0510R-473-D	J24189159			
R 1080	CHIP RES.	47K	1/16W	0.5%	RR0510R-473-D	J24189159			
R 1081	CHIP RES.	680	1/16W	0.5%	RR0510P-681-D	J24189115			
R 1082	CHIP RES.	2.7K	1/16W	0.5%	RR0510P-272-D	J24189129			
R 1083	CHIP RES.	2.2K	1/16W	0.5%	RR0510P-222-D	J24189127			
R 1084	CHIP RES.	3.3K	1/16W	0.5%	RR0510P-332-D	J24189131			
R 1085	CHIP RES.	6.8K	1/16W	0.5%	RR0510P-682-D	J24189139			
R 1086	CHIP RES.	6.8K	1/16W	0.5%	RR0510P-682-D	J24189139			
R 1087	CHIP RES.	47K	1/16W	0.5%	RR0510R-473-D	J24189159			
R 1087	CHIP RES.	27K	1/16W	0.5%	RR0510R-273-D	J24189153		2-	
R 1088	CHIP RES.	4.7K	1/16W	0.5%	RR0510P-472-D	J24189135			
R 1089	CHIP RES.	4.7K	1/16W	0.5%	RR0510P-472-D	J24189135			
R 1090	CHIP RES.	1.5K	1/16W	0.5%	RR0510P-152-D	J24189123			
R 1091	CHIP RES.	1.2K	1/16W	0.5%	RR0510P-122-D	J24189121			
R 1092	CHIP RES.	22K	1/16W	0.5%	RR0510R-223-D	J24189151			
R 1093	CHIP RES.	100K	1/16W	0.5%	RR0510R-104-D	J24189167			
R 1094	CHIP RES.	680K	1/16W	5%	RMC1/16S 684JTH	J24189059			
R 1095	CHIP RES.	180K	1/16W	5%	RMC1/16S 184JTH	J24189052			
R 1096	CHIP RES.	6.8K	1/16W	0.5%	RR0510P-682-D	J24189139			
R 1097	CHIP RES.	100K	1/16W	0.5%	RR0510R-104-D	J24189167			
R 1097	CHIP RES.	22K	1/16W	0.5%	RR0510R-223-D	J24189151		3-	
R 1098	CHIP RES.	10K	1/16W	0.5%	RR0510P-103-D	J24189143			
R 1098	CHIP RES.	6.8K	1/16W	0.5%	RR0510P-682-D	J24189139		3-	
R 1099	CHIP RES.	10K	1/16W	0.5%	RR0510P-103-D	J24189143			
R 1100	CHIP RES.	100	1/16W	0.5%	RR0510P-101-D	J24189095			
R 1101	CHIP RES.	1.8K	1/16W	0.5%	RR0510P-182-D	J24189125			
R 1102	CHIP RES.	100K	1/16W	0.5%	RR0510R-104-D	J24189167			
R 1103	CHIP RES.	330	1/16W	0.5%	RR0510P-331-D	J24189107			
R 1104	CHIP RES.	39	1/16W	0.5%	RR0510R-390-D	J24189085			
R 1105	CHIP RES.	330K	1/16W	5%	RMC1/16S 334JTH	J24189055			
R 1105	CHIP RES.	68K	1/16W	0.5%	RR0510R-683-D	J24189163		2-	
R 1106	CHIP RES.	470	1/16W	0.5%	RR0510P-471-D	J24189111			
R 1107	CHIP RES.	470	1/16W	0.5%	RR0510P-471-D	J24189111			
R 1108	CHIP RES.	27K	1/16W	0.5%	RR0510R-273-D	J24189153			
R 1109	CHIP RES.	220	1/16W	0.5%	RR0510P-221-D	J24189103			
R 1109	CHIP RES.	330	1/16W	0.5%	RR0510P-331-D	J24189107		5-	
R 1110	CHIP RES.	33K	1/16W	0.5%	RR0510R-333-D	J24189155			
R 1111	CHIP RES.	100K	1/16W	0.5%	RR0510R-104-D	J24189167			
R 1112	CHIP RES.	100K	1/16W	0.5%	RR0510R-104-D	J24189167			
R 1113	CHIP RES.	100K	1/16W	0.5%	RR0510R-104-D	J24189167			
R 1114	CHIP RES.	100K	1/16W	0.5%	RR0510R-104-D	J24189167			
R 1115	CHIP RES.	470	1/16W	0.5%	RR0510P-471-D	J24189111			
R 1116	CHIP RES.	100K	1/16W	0.5%	RR0510R-104-D	J24189167			
R 1117	CHIP RES.	1K	1/16W	0.5%	RR0510P-102-D	J24189119			
R 1118	CHIP RES.	330K	1/16W	5%	RMC1/16S 334JTH	J24189055			
R 1119	CHIP RES.	470	1/16W	0.5%	RR0510P-471-D	J24189111			
R 1120	CHIP RES.	0	1/16W	5%	RMC1/16S JPTH	J24189070		2-	
R 1120	CHIP RES.	3.3K	1/16W	5%	RR0510P-332-D	J24189131		5-	
R 1121	CHIP RES.	33K	1/16W	0.5%	RR0510R-333-D	J24189155			

MOTHER Unit

REF.	DESCRIPTION	VALUE	WV	TOL.	MFGR'S DESIG	YAESU P/N	VERS.	LOT.	LAY ADR
R 1122	CHIP RES.	470	1/16W	0.5%	RR0510P-471-D	J24189111			
R 1123	CHIP RES.	47K	1/16W	0.5%	RR0510R-473-D	J24189159			
R 1124	CHIP RES.	68K	1/16W	0.5%	RR0510R-683-D	J24189163			
R 1125	CHIP RES.	150K	1/16W	5%	RMC1/16S 154JTH	J24189051			
R 1126	CHIP RES.	680	1/16W	0.5%	RR0510P-681-D	J24189115			
R 1127	CHIP RES.	270K	1/16W	5%	RMC1/16S 274JTH	J24189054			
R 1128	CHIP RES.	100K	1/16W	0.5%	RR0510R-104-D	J24189167			
R 1130	CHIP RES.	0	1/16W	5%	RMC1/16S JPTH	J24189070			
R 1131	CHIP RES.	4. 7K	1/16W	0.5%	RR0510P-472-D	J24189135			
R 1132	CHIP RES.	6. 8K	1/16W	0.5%	RR0510P-682-D	J24189139			
R 1133	CHIP RES.	6. 8K	1/16W	0.5%	RR0510P-682-D	J24189139			
R 1134	CHIP RES.	0	1/10W	5%	RMC1/10T 000J	J24205000			
R 1135	CHIP RES.	0	1/16W	5%	RMC1/16S JPTH	J24189070			
R 1136	CHIP RES.	0	1/16W	5%	RMC1/16S JPTH	J24189070			
R 1137	CHIP RES.	220	1/16W	0.5%	RR0510P-221-D	J24189103			-4
R 1138	CHIP RES.	0	1/16W	5%	RMC1/16S JPTH	J24189070			5-
R 1140	CHIP RES.	1K	1/16W	0.5%	RR0510P-102-D	J24189119			5-
TC1001	TRIMMER CAP.	20pF			CT22S-20C-W2-P	K91000216			
TC1002	TRIMMER CAP.	6pF			TC13C060C-TP03	K91000220			
TC1003	TRIMMER CAP.	6pF			TC13C060C-TP03	K91000220			
TC1004	TRIMMER CAP.	6pF			TC13C060C-TP03	K91000220			
TC1005	TRIMMER CAP.	6pF			TC13C060C-TP03	K91000220			
TH1001	THERMISTER				TBPS1R103K440H5Q	G9090067			
VR1001	POT.	47K			MVR22HXBRN473	J51799473			
VR1002	POT.	47K			MVR22HXBRN473	J51799473			
X 1001	XTAL	12. 8000MHz				H0103105			
X 1002	XTAL	46. 645MHz				H0103135			
XF1001	XTAL				45N20A6	H1102275			
	CONTACT PLATE (SMA)					R0152360			
	CONTACT PLATE (SMA)					R0152360A		12-	
	SPRING CONNECTOR					R0152480			
	LEAF SPRING					R0153210		20-	
	SHIELD CASE (F. END)					R0522330			
	PACKING PAD (POW)					R3152430			

Circuit Diagram

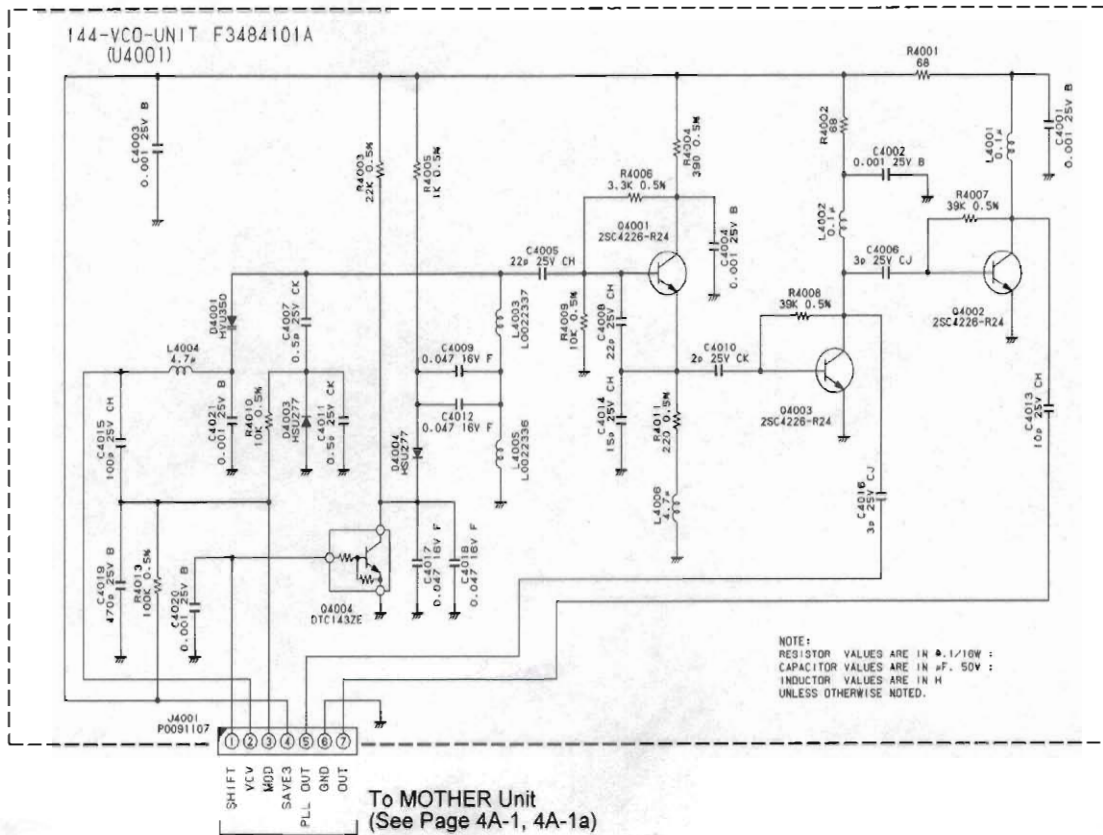

Parts Layout

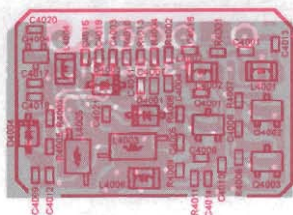

Component Side

J4001
To MOTHER Unit
(See Page 4A-3, 4A-3a)

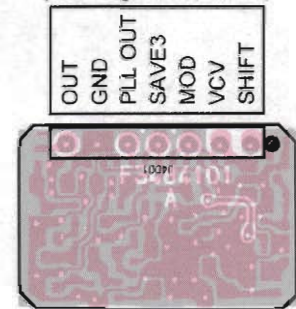

Connector Side

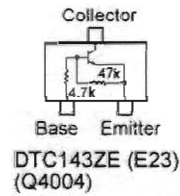
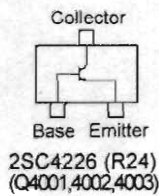

144-VCO Unit

Notes:

Parts List

REF.	DESCRIPTION	VALUE	WV	TOL.	MFGR'S DESIG	YAESU P/N	VERS.	LOT.	LAY ADR
*** 144-VCO UNIT ***									
PCB with Components						CA1550001			
Printed Circuit Board						F3484101A			
C 4001	CHIP CAP.	0.001uF	25V	B	TMK105B102K-F	K22148820			
C 4002	CHIP CAP.	0.001uF	25V	B	TMK105B102K-F	K22148820			
C 4003	CHIP CAP.	0.001uF	25V	B	TMK105B102K-F	K22148820			
C 4004	CHIP CAP.	0.001uF	25V	B	TMK105B102K-F	K22148820			
C 4005	CHIP CAP.	22pF	25V	CH	TMK105CH220J-F	K22148222			
C 4006	CHIP CAP.	3pF	25V	CJ	TMK105CJ030C-F	K22148207			
C 4007	CHIP CAP.	0.5pF	25V	CK	TMK105CK0R5C-F	K22148204			
C 4008	CHIP CAP.	22pF	25V	CH	TMK105CH220J-F	K22148222			
C 4009	CHIP CAP.	0.047uF	16V	F	EMK105F473Z-F	K22129002			
C 4010	CHIP CAP.	2pF	25V	CK	TMK105CK020C-F	K22148206			
C 4011	CHIP CAP.	0.5pF	25V	CK	TMK105CK0R5C-F	K22148204			
C 4012	CHIP CAP.	0.047uF	16V	F	EMK105F473Z-F	K22129002			
C 4013	CHIP CAP.	10pF	25V	CH	TMK105CH100D-F	K22148214			
C 4014	CHIP CAP.	15pF	25V	CH	TMK105CH150J-F	K22148218			
C 4015	CHIP CAP.	39pF	25V	CH	TMK105CH390J-F	K22148228			
C 4015	CHIP CAP.	100pF	25V	CH	TMK105CH101J-F	K22148238		5-	
C 4016	CHIP CAP.	3pF	25V	CJ	TMK105CJ030C-F	K22148207			
C 4017	CHIP CAP.	0.047uF	16V	F	EMK105F473Z-F	K22129002			
C 4018	CHIP CAP.	0.047uF	16V	F	EMK105F473Z-F	K22129002			
C 4019	CHIP CAP.	470pF	25V	B	TMK105B471K-F	K22148816			
C 4020	CHIP CAP.	0.001uF	25V	B	TMK105B102K-F	K22148820			
C 4021	CHIP CAP.	0.001uF	25V	B	TMK105B102K-F	K22148820			
D 4001	DIODE				HVU350-TR	G2070380			
D 4003	DIODE				HSU277	G2070118			
D 4004	DIODE				HSU277	G2070118			
J 4001	CONNECTOR				9213B-1-07C-T	P0091030			
J 4001	CONNECTOR				9213B-1-07Z012-T	P0091107		5-	
L 4001	M. RFC	0.1uH			LK2125 R10K-T	L1690307			
L 4002	M. RFC	0.1uH			LK2125 R10K-T	L1690307			
L 4003	COIL				LE231110CL01	L0022337			
L 4004	M. RFC	4.7uH			LK2125 4R7K-T	L1690327			
L 4005	COIL				LE231107CL01	L0022336			
L 4006	M. RFC	4.7uH			LK2125 4R7K-T	L1690327			
Q 4001	TRANSISTOR				2SC4226-T2B R24	G3342267D			
Q 4002	TRANSISTOR				2SC4226-T2B R24	G3342267D			
Q 4003	TRANSISTOR				2SC4226-T2B R24	G3342267D			
Q 4004	TRANSISTOR				DTC143ZE TL	G3070102			
R 4001	CHIP RES.	68	1/16W	5%	RMC1/16S 680JTH	J24189011			
R 4002	CHIP RES.	68	1/16W	5%	RMC1/16S 680JTH	J24189011			
R 4003	CHIP RES.	22K	1/16W	0.5%	RR0510R-223-D	J24189151			
R 4004	CHIP RES.	390	1/16W	0.5%	RR0510P-391-D	J24189109			
R 4005	CHIP RES.	1K	1/16W	0.5%	RR0510P-102-D	J24189119			
R 4006	CHIP RES.	3.3K	1/16W	0.5%	RR0510P-332-D	J24189131			
R 4007	CHIP RES.	39K	1/16W	0.5%	RR0510R-393-D	J24189157			
R 4008	CHIP RES.	39K	1/16W	0.5%	RR0510R-393-D	J24189157			
R 4009	CHIP RES.	10K	1/16W	0.5%	RR0510P-103-D	J24189143			
R 4010	CHIP RES.	10K	1/16W	0.5%	RR0510P-103-D	J24189143			
R 4011	CHIP RES.	220	1/16W	0.5%	RR0510P-221-D	J24189103			
R 4013	CHIP RES.	100K	1/16W	0.5%	RR0510R-104-D	J24189167			
	SHIELD CASE (VCO)					R0150240			

144-VCO Unit

Notes:

144-VCO Unit

Circuit Diagram

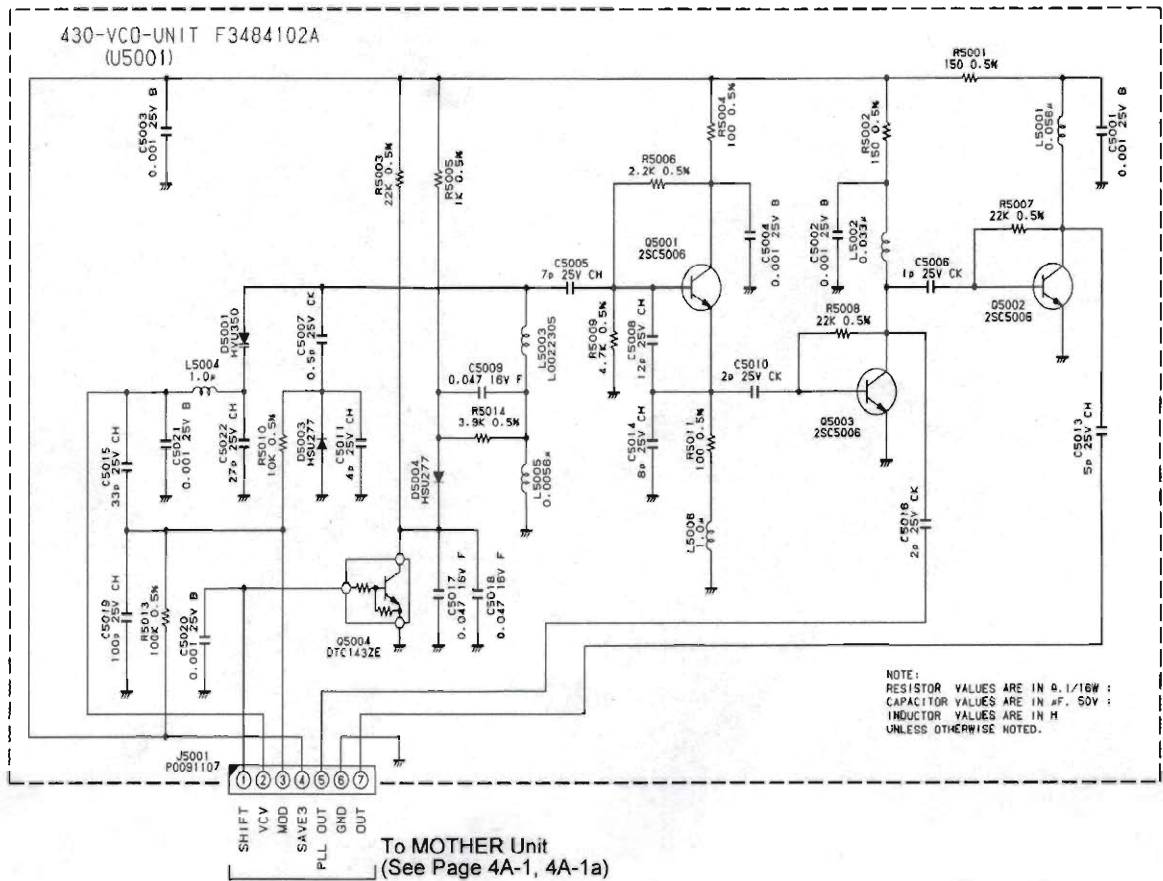

Parts Layout

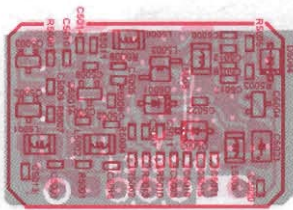

Component Side

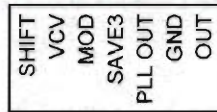
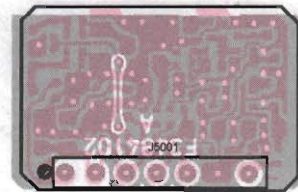

J5001
To MOTHER Unit
(See Page 4A-3, 4A-3a)
Connector Side

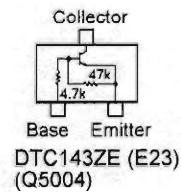
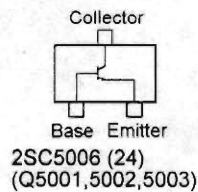

Parts List

REF.	DESCRIPTION	VALUE	WV	TOL.	MFGR'S DESIG	YAESU P/N	VERS.	LOT.	LAY ADR
*** 430-VCO UNIT ***									
PCB with Components						CA1551001			
Printed Circuit Board						F3484102A			
C 5001	CHIP CAP.	0.001uF	25V	B	TMK105B102K-F	K22148820			
C 5002	CHIP CAP.	0.001uF	25V	B	TMK105B102K-F	K22148820			
C 5003	CHIP CAP.	0.001uF	25V	B	TMK105B102K-F	K22148820			
C 5004	CHIP CAP.	0.001uF	25V	B	TMK105B102K-F	K22148820			
C 5005	CHIP CAP.	7pF	25V	CH	TMK105CH070D-F	K22148211			
C 5006	CHIP CAP.	1pF	25V	CK	TMK105CK010C-F	K22148205			
C 5007	CHIP CAP.	0.5pF	25V	CK	TMK105CK0R5C-F	K22148204			
C 5008	CHIP CAP.	12pF	25V	CH	TMK105CH120J-F	K22148216			
C 5009	CHIP CAP.	0.047uF	16V	F	EMK105F473Z-F	K22129002			
C 5010	CHIP CAP.	2pF	25V	CK	TMK105CK020C-F	K22148206			
C 5011	CHIP CAP.	4pF	25V	CH	TMK105CH040C-F	K22148208			
C 5013	CHIP CAP.	5pF	25V	CH	TMK105CH050C-F	K22148209			
C 5014	CHIP CAP.	8pF	25V	CH	TMK105CH080D-F	K22148212			
C 5015	CHIP CAP.	33pF	25V	CH	TMK105CH330J-F	K22148226			
C 5016	CHIP CAP.	2pF	25V	CK	TMK105CK020C-F	K22148206			
C 5017	CHIP CAP.	0.047uF	16V	F	EMK105F473Z-F	K22129002			
C 5018	CHIP CAP.	0.047uF	16V	F	EMK105F473Z-F	K22129002			
C 5019	CHIP CAP.	100pF	25V	CH	TMK105CH101J-F	K22148238			
C 5020	CHIP CAP.	0.001uF	25V	B	TMK105B102K-F	K22148820			
C 5021	CHIP CAP.	0.001uF	25V	B	TMK105B102K-F	K22148820			
C 5022	CHIP CAP.	27pF	25V	CH	TMK105CH270J-F	K22148224			
D 5001	DIODE				HVU350-TR	G2070380			
D 5003	DIODE				HSU277	G2070118			
D 5004	DIODE				HSU277	G2070118			
J 5001	CONNECTOR				9213B-1-07C-T	P0091030			
J 5001	CONNECTOR				9213B-1-07Z012-T	P0091107		5-	
L 5001	M. RFC	0.056uH			HK2125 56NK-T	L1690386			
L 5002	M. RFC	0.033uH			HK2125 33NK-T	L1690383			
L 5003	COIL				LE231104CL01	L0022305			
L 5004	M. RFC	1.0uH			LK2125 1R0K-T	L1690319			
L 5005	M. RFC	0.0056uH			HK2125 5N6K-T	L1690374			
L 5006	M. RFC	1.0uH			LK2125 1R0K-T	L1690319			
Q 5001	TRANSISTOR				2SC5006-T1	G3350068			
Q 5002	TRANSISTOR				2SC5006-T1	G3350068			
Q 5003	TRANSISTOR				2SC5006-T1	G3350068			
Q 5004	TRANSISTOR				DTC143ZE TL	G3070102			
R 5001	CHIP RES.	150	1/16W	0.5%	RR0510P-151-D	J24189099			
R 5002	CHIP RES.	150	1/16W	0.5%	RR0510P-151-D	J24189099			
R 5003	CHIP RES.	22K	1/16W	0.5%	RR0510R-223-D	J24189151			
R 5004	CHIP RES.	100	1/16W	0.5%	RR0510P-101-D	J24189095			
R 5005	CHIP RES.	1K	1/16W	0.5%	RR0510P-102-D	J24189119			
R 5006	CHIP RES.	2.2K	1/16W	0.5%	RR0510P-222-D	J24189127			
R 5007	CHIP RES.	22K	1/16W	0.5%	RR0510R-223-D	J24189151			
R 5008	CHIP RES.	22K	1/16W	0.5%	RR0510R-223-D	J24189151			
R 5009	CHIP RES.	4.7K	1/16W	0.5%	RR0510P-472-D	J24189135			
R 5010	CHIP RES.	10K	1/16W	0.5%	RR0510P-103-D	J24189143			
R 5011	CHIP RES.	100	1/16W	0.5%	RR0510P-101-D	J24189095			
R 5013	CHIP RES.	100K	1/16W	0.5%	RR0510R-104-D	J24189167			
R 5014	CHIP RES.	3.9K	1/16W	0.5%	RR0510P-392-D	J24189133			
	SHIELD CASE (VCO)					R0150240			
	COIL SPRING					R0154810		14-	

430-VCO Unit

Notes:

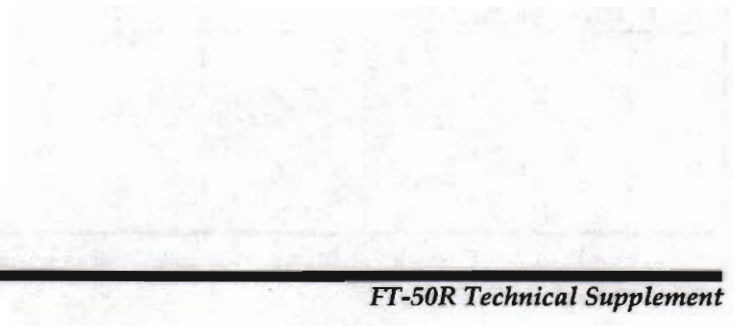
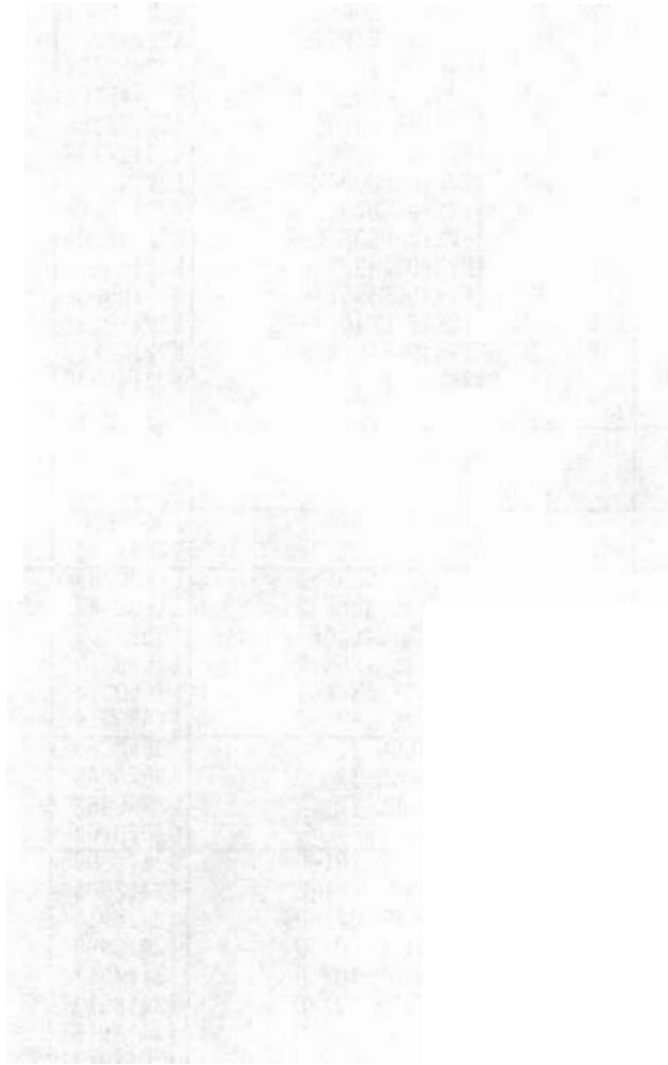

Circuit Diagram

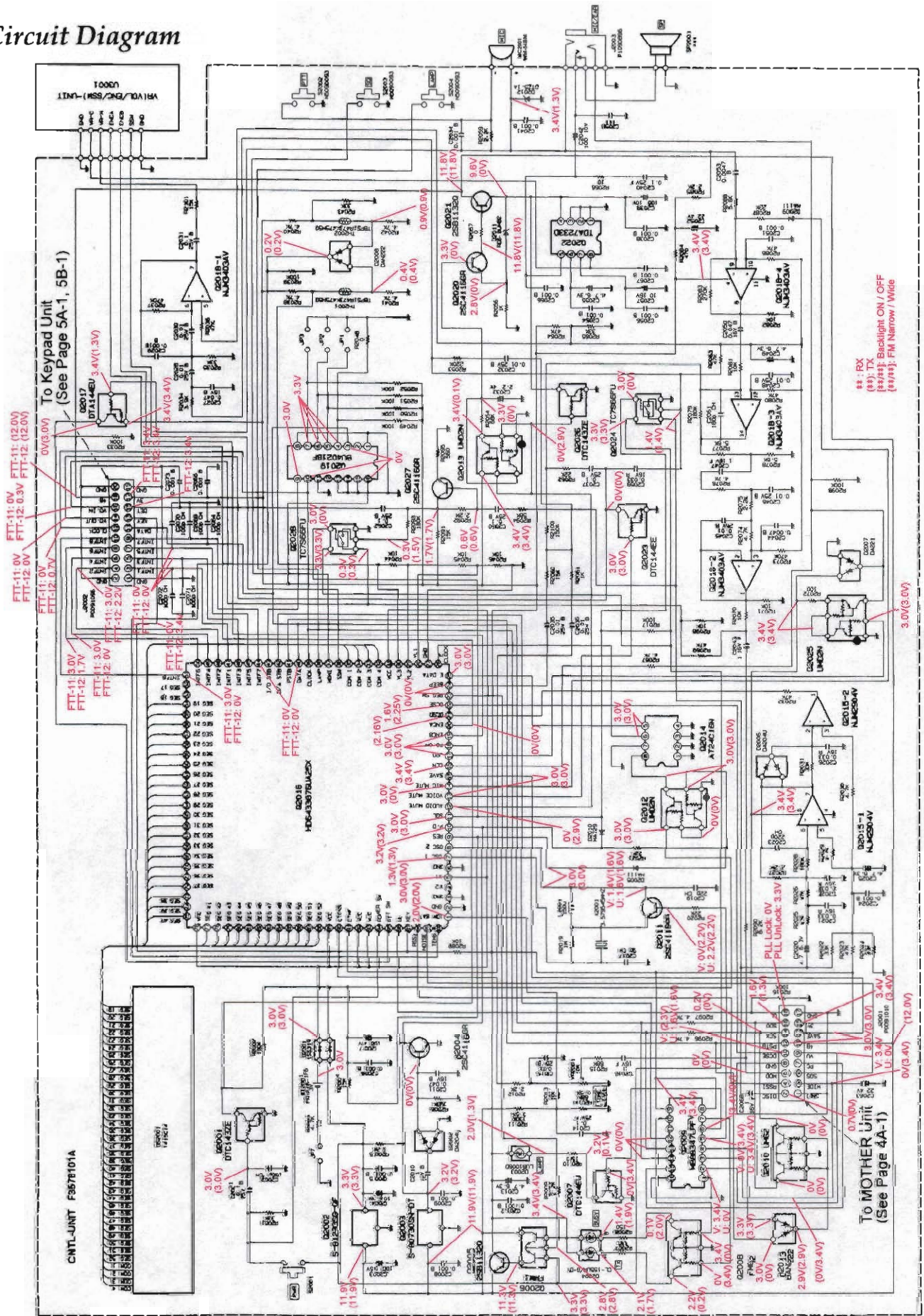

CNTL Unit

Notes:

Circuit Diagram

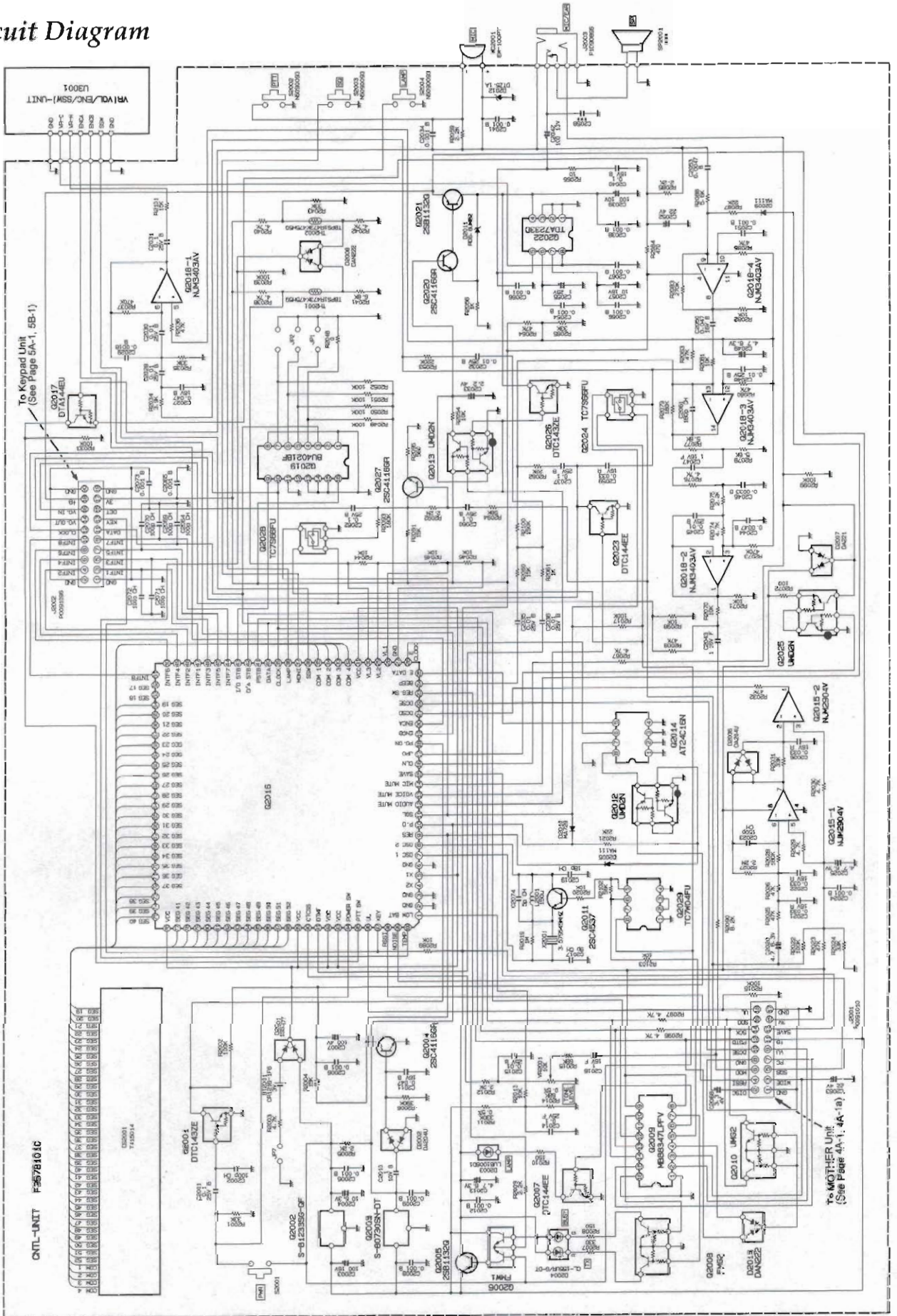

CNTL Unit (Lot. 5~)

Notes:

Parts Layout

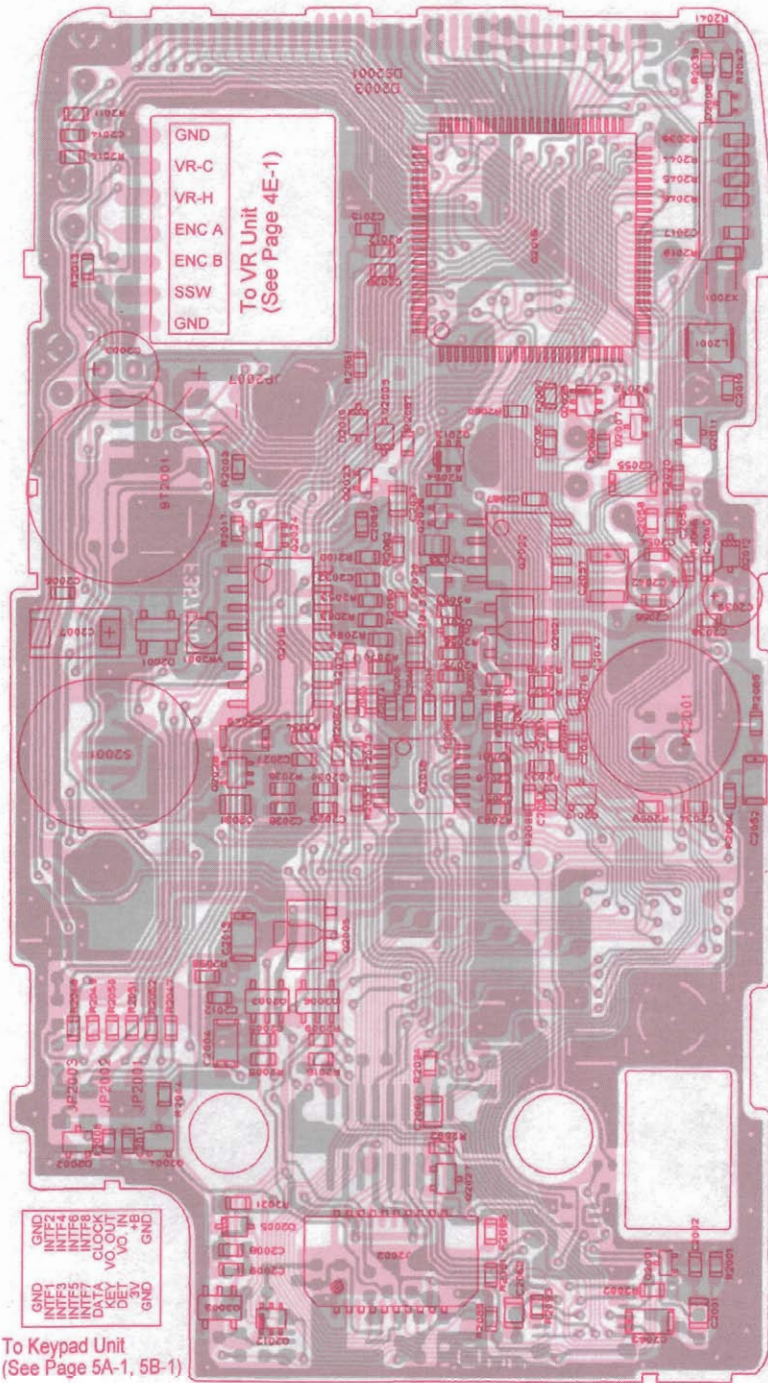

LCD Side

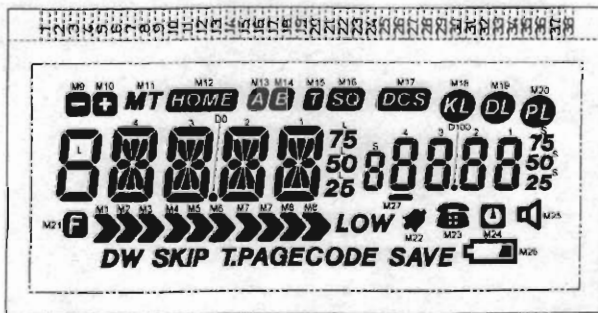

DS2001 LCD Display

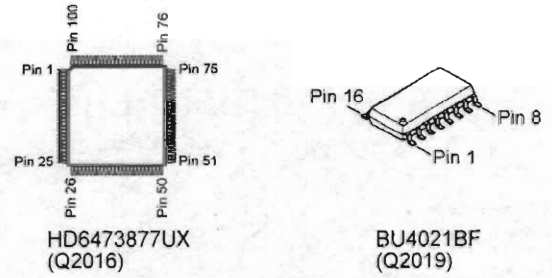

HD6473877UX (Q2016)

BU4021BF (Q2019)



TDA7233D (Q2022)
NJM3403AV (Q2018)

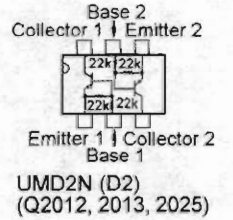

UMD2N (D2) (Q2012, 2013, 2025)

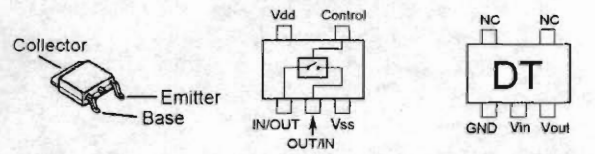

2SB1132Q (BA) (Q2005, 2021)

TC7S66FU (E9) (Q2024, 2028)

S-80730SN (DT) (Q2003)

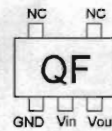

QF

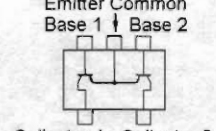

FMW1 (W1) (Q2006)

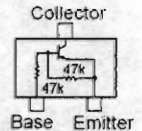

DTA144EU (16) (Q2017)

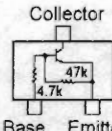

DTC143ZE (E23) (Q2001, 2026)

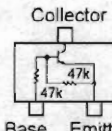

DTC144EE (26) (Q2023)

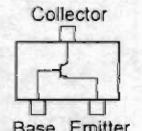

2SC4116GR (LG) (Q2004, 2011, 2020, 2027)

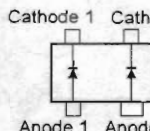

1SS319 (A4) (D2001)

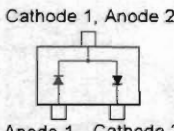

DA221 (K) (D2007)
DA204U (K) (D2002)

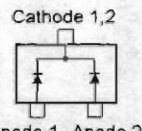

DAN222 (N) (D2008)

No.	COM3	COM2	COM1	COM0
1	.	.	.	COM0
2	.	.	COM1	.
3	.	COM2	.	.
4	COM3	.	.	.
5	LA	LF	LE	LD
6	DW	LB	LG	LC
7	M9	4f	4i	4e
8	M10	4g	4n	4l
9	4a	4i	4m	4d
10	4b	4k	4c	M21
11	M11	3f	3j	3e
12	M12	3g	3h	3i
13	3a	3i	3m	3d
14	3b	3k	3c	DO
15	M13	2f	2i	2e
16	M14	2g	2h	2i
17	2a	2i	2m	2d
18	2b	2k	2c	MB
19	M15	1f	1j	1e

No.	COM3	COM2	COM1	COM0
20	M16	1g	1h	1i
21	1a	1i	1m	1d
22	1b	1k	1c	LOW
23	L75	L50	L25	M27
24	SA	SF	SE	SD
25	M17	SB	SG	SC
26	4A	4F	4E	4C
27	M18	4B	4G	4C
28	3A	3F	3E	3C
29	M19	3B	3G	3C
30	2A	2F	2E	2D
31	M20	2B	2G	2C
32	1A	1F	1E	1D
33	S75	1B	1G	1C
34	S50	S25	M24	M25
35	M26	M23	M22	D100
36	SAVE	T	PAGE	CODE
37	SKIP	M5	M6	M7
38	M4	M3	M2	M1

CNTL Unit

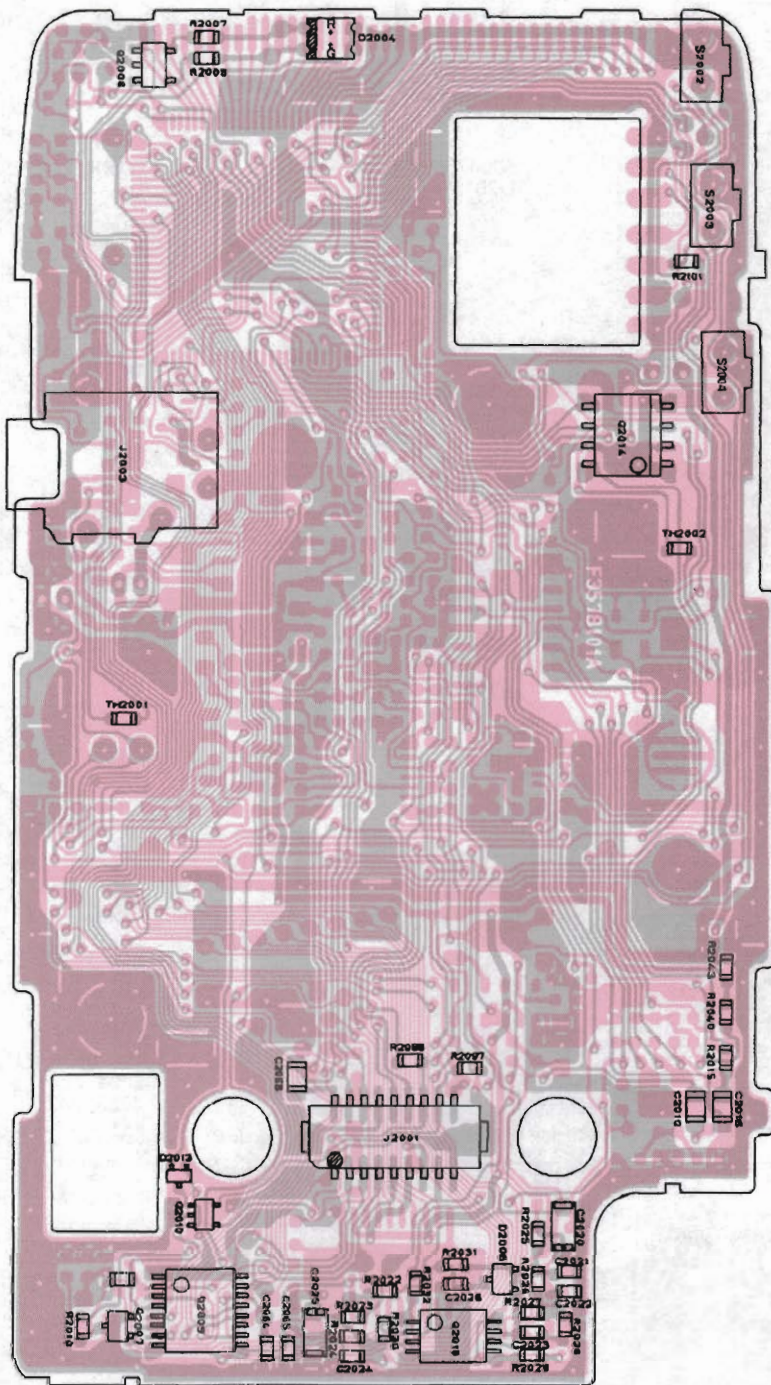

DISC
 RSSI
 WIDE MOD
 SCS GND
 PC DCSE
 VU DCSE
 +B PSTB
 SAVE SCK
 3V SDO
 GND LUL

To MOTHER Unit J1001
(See Page 4A-3)

Component Side

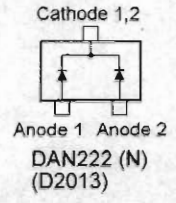
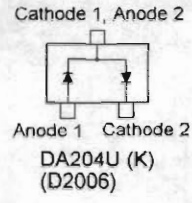
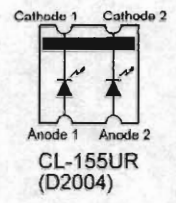
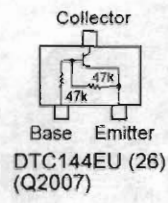
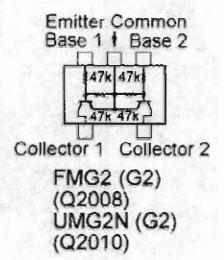
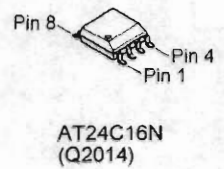
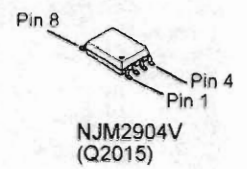
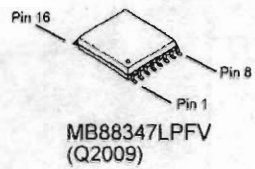

Parts Layout

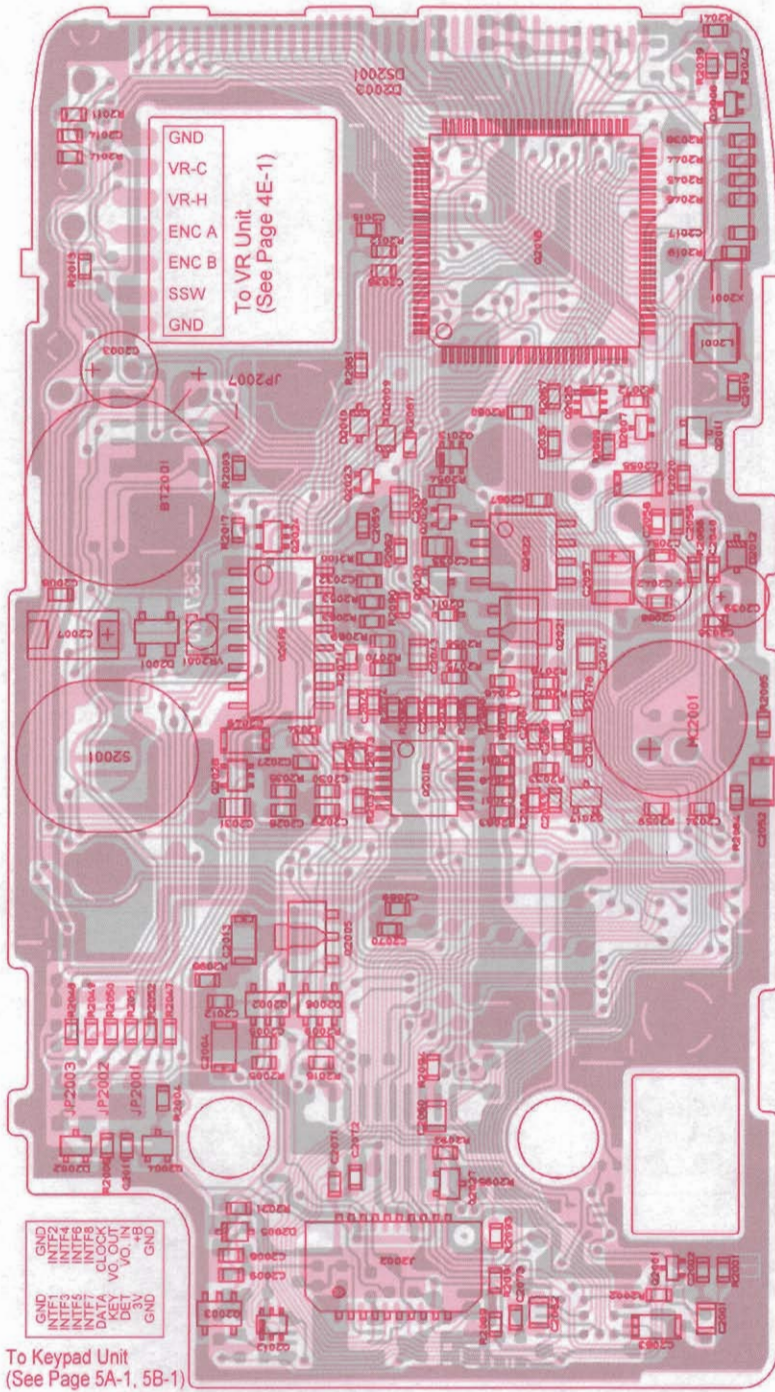

LCD Side



DS2001 LCD Display

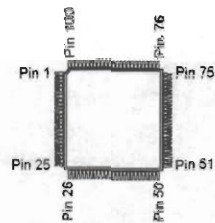

HD6433876UA (Q2016)

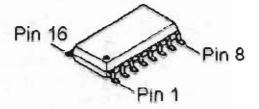

BU4021BF (Q2019)



TDA7233D (Q2022)
NJM3403AV (Q2018)

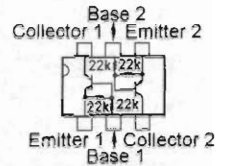

UMD2N (D2) (Q2012, 2013, 2025)

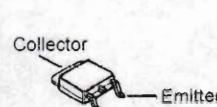

2SB1132Q (BA) (Q2005, 2021)

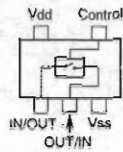

TC7S66FU (E9) (Q2024, 2028)

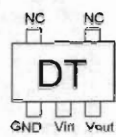

S-80730SN (DT) (Q2003)

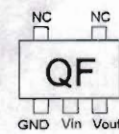

S-81233SG (Q2002)

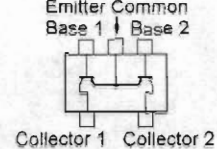

FMW1 (W1) (Q2006)

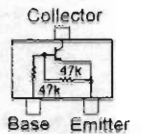

DTA144EU (16) (Q2017)

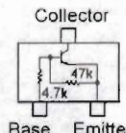

DTC143ZE (E23) (Q2001, 2026)

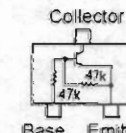

DTC144EE (26) (Q2023)

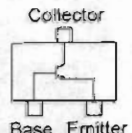

2SC4116GR (LG) (Q2004, 2011, 2020, 2027)

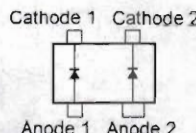

1SS319 (A4) (D2001)

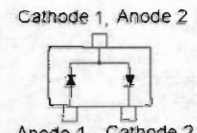

DA221 (K) (D2007)
DA204U (K) (D2002)

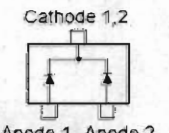

DAN222 (N) (D2008)

No.	COM3	COM2	COM1	COM0
1	-	-	-	COM0
2	-	-	COM1	-
3	-	COM2	-	-
4	COM3	-	-	-
5	LA	LF	LE	LD
6	DW	LB	LG	LC
7	M9	4f	4j	4e
8	M10	4g	4n	4i
9	4a	4i	4m	4d
10	4b	4k	4c	N21
11	M11	3f	3j	3e
12	M12	3g	3h	3f
13	3a	3i	3m	3d
14	3b	3k	3c	D8
15	M13	2f	2j	2e
16	M14	2g	2h	2f
17	2a	2i	2m	2d
18	2b	2k	2c	M8
19	M15	1f	1j	1e

No.	COM5	COM2	COM1	COM0
20	M16	1g	1h	1i
21	1a	1i	1m	1d
22	1b	1k	1c	LOW
23	L75	L50	L25	M27
24	SA	SP	SE	SD
25	M17	SB	SG	SC
26	4A	4F	4E	4D
27	M18	4B	4G	4C
28	3A	3F	3E	3D
29	M19	3B	3G	3C
30	2A	2F	2E	2D
31	M20	2B	2G	2C
32	1A	1F	1E	1D
33	S75	S5	S15	S1C
34	S90	S25	M24	M25
35	M28	M23	M22	D100
36	SAPL	S11	PAGE CODE	-
37	SKIP	M5	M6	M7
38	M4	M3	M2	M1

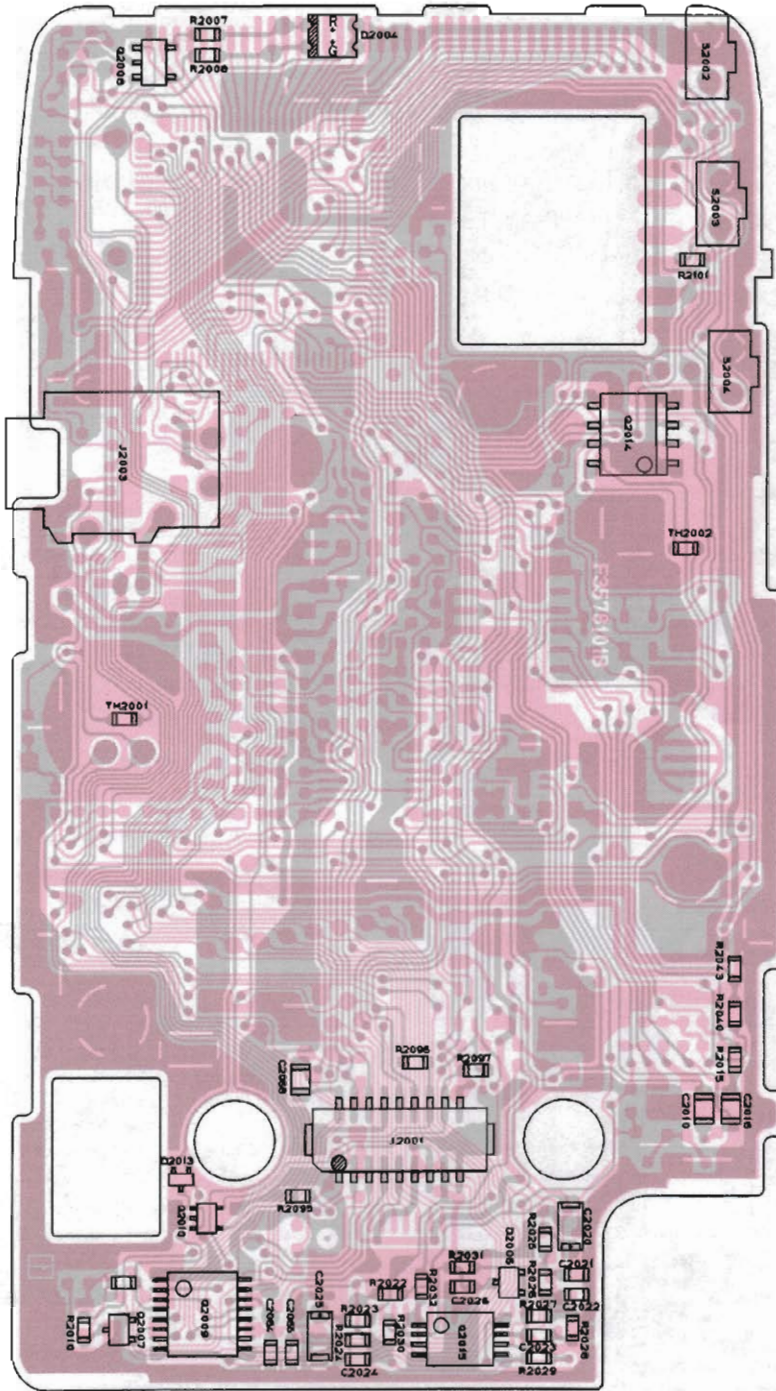

GND	DISC
MODE	RSSI
SOX	MOD
PC	GND
VU	DCSE
+B	PSTB
SAVE	SCK
3V	SDO
GND	UL

To MOTHER Unit J1001
(See Page 4A-3, 4A-3a)

Component Side

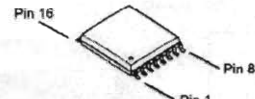

MB88347LPFV
(Q2009)

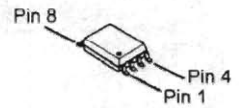

NJM2904V
(Q2015)



AT24C16N
(Q2014)

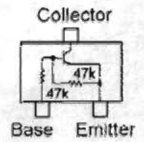
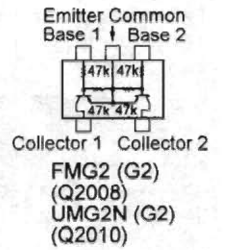

DTC144EU (26)
(Q2007)

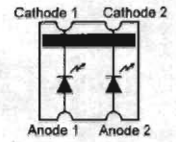

CL-155UR
(D2004)

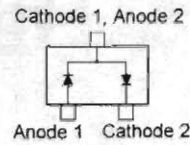

DA204U (K)
(D2006)

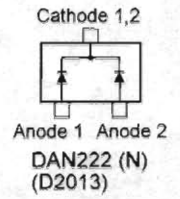

DAN222 (N)
(D2013)

Parts Layout

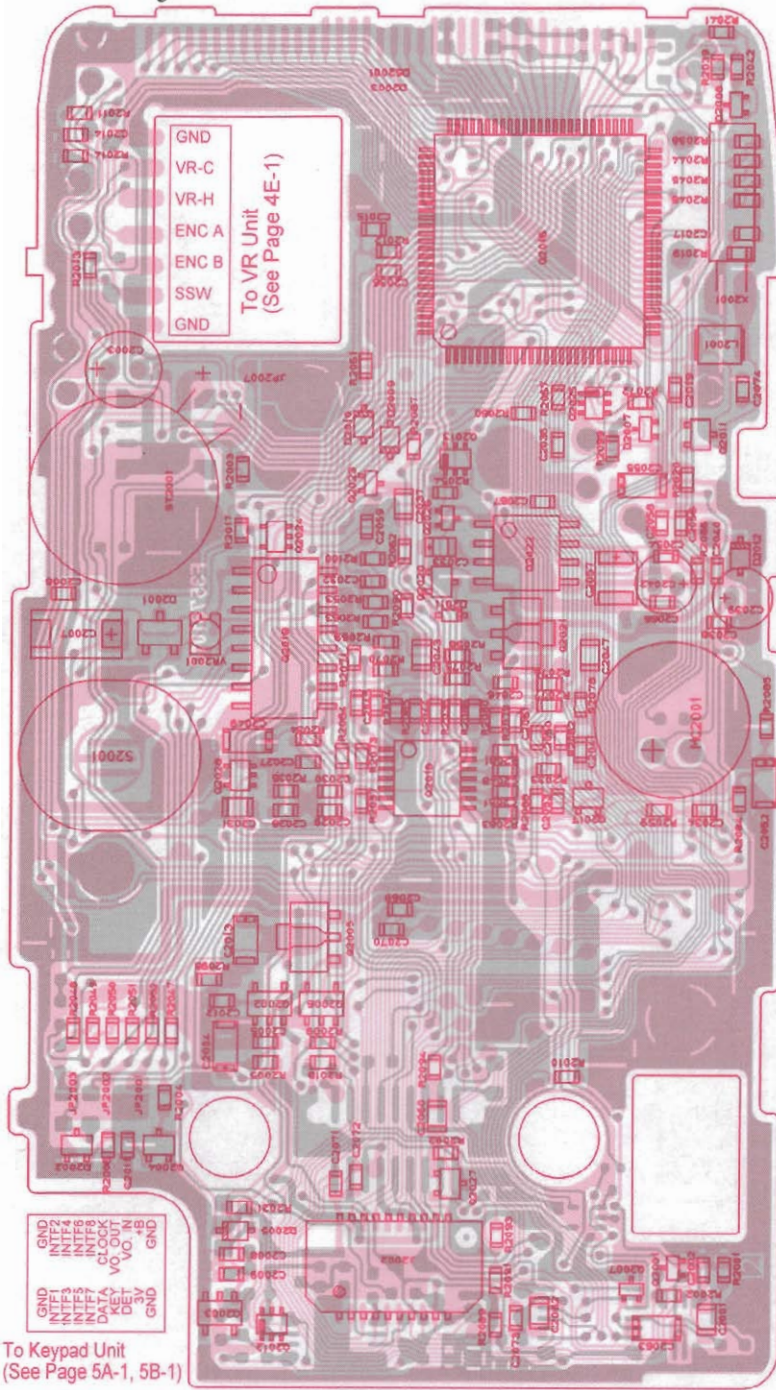

LCD Side

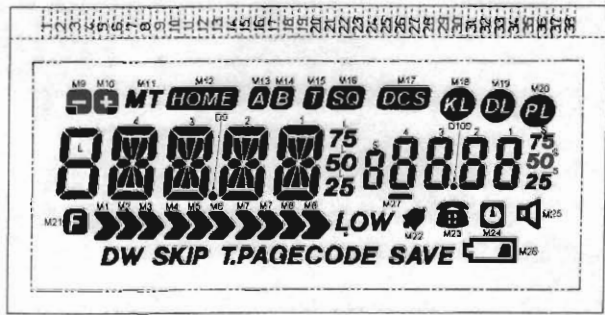

DS2001 LCD Display

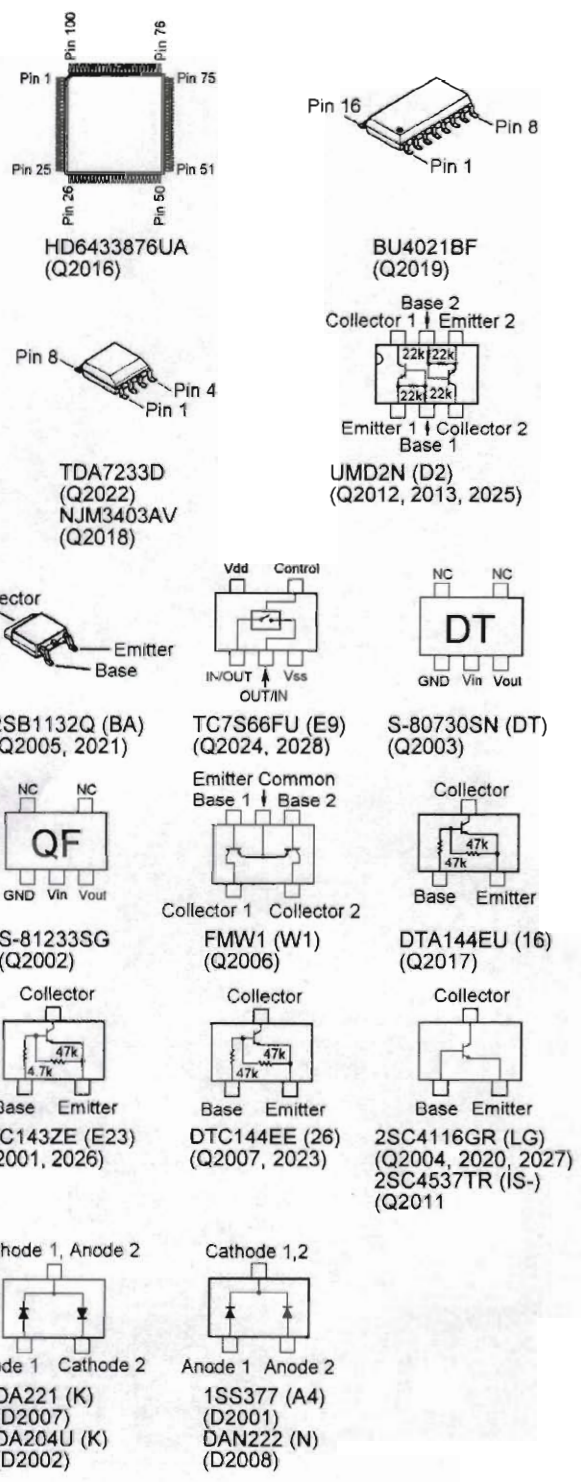

No.	COM3	COM2	COM1	COM0
1	-	-	-	COM0
2	-	-	COM1	-
3	-	COM2	-	-
4	COM3	-	-	-
5	LA	LF	LE	LD
6	DW	LB	LG	LC
7	M9	4f	4j	4e
8	M10	4g	4n	4i
9	4a	4i	4m	4d
10	4b	4k	4c	M21
11	M11	9f	3j	3e
12	M12	3g	3h	3i
13	3a	3i	3m	3d
14	9b	9k	3c	DD
15	M13	2f	2j	2e
16	M14	2g	2h	2i
17	2a	2i	2m	2d
18	2b	2k	2c	M8
19	M15	1f	1j	1e

No.	COM3	COM2	COM1	COM0
20	M16	1g	1h	1i
21	1a	1i	1m	1d
22	1b	1k	1e	LOW
23	L75	L50	L25	M27
24	SA	SF	SE	SD
25	M17	9B	9G	9C
26	4A	4F	4E	4D
27	M18	4B	4G	4C
28	3A	3F	3E	3D
29	M19	3B	3G	3C
30	2A	2F	2E	2D
31	M20	2B	2G	2C
32	1A	1F	1E	1D
33	S75	1B	1G	1C
34	S50	S25	M24	M25
35	M26	M23	M22	D100
36	SAVE	T	PAGE	CODE
37	SKIP	M5	M6	M7
38	M4	M3	M2	M1

CNTL Unit (Lot. 12~)

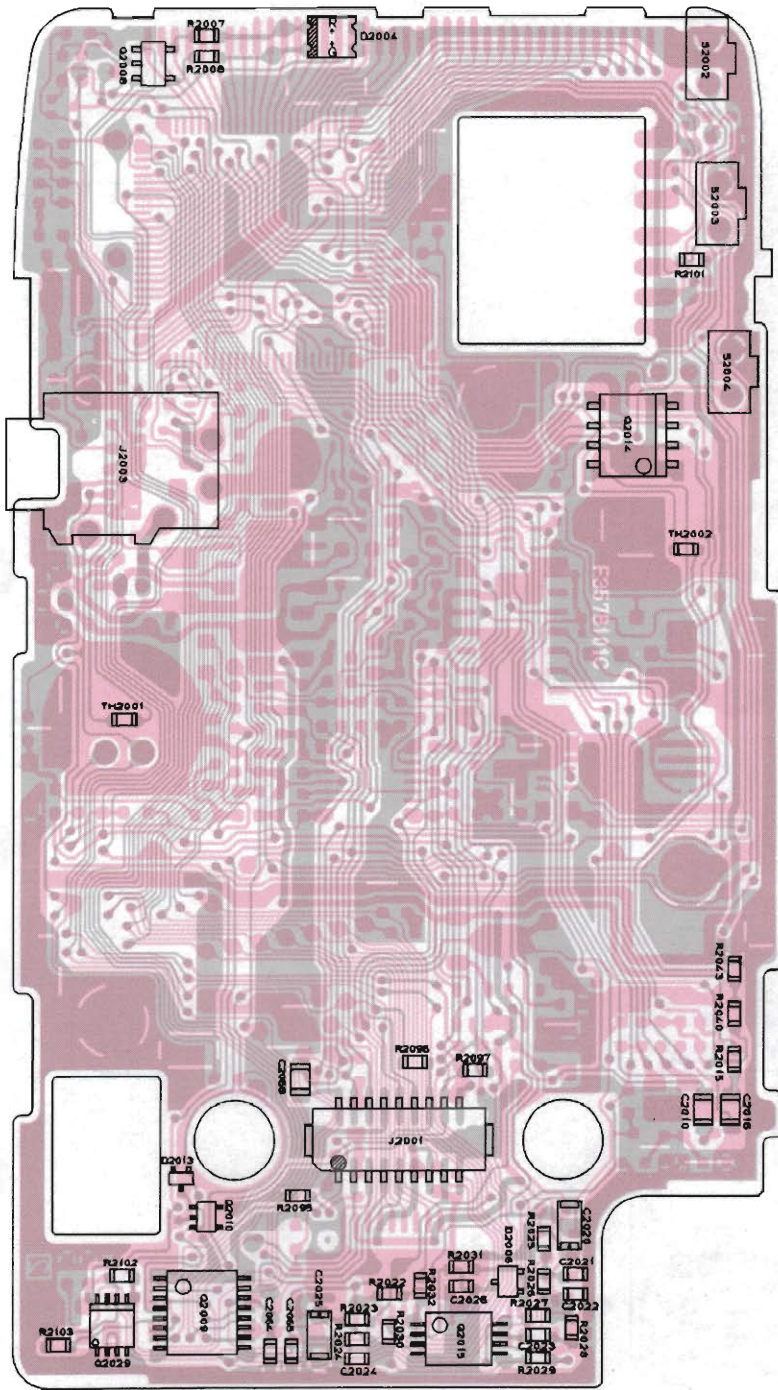

DISC
 WIDE RSSI
 SQS MOD
 PC GND
 VU DCSE
 S+VE PS1B
 S-VE SCK
 GND VU
 UL
 To MOTHER Unit J1001
 (See Page 4A-3, 4A-3a)

Component Side

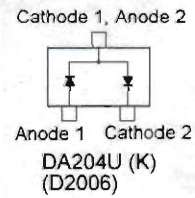
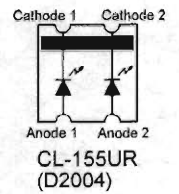
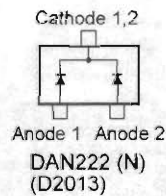
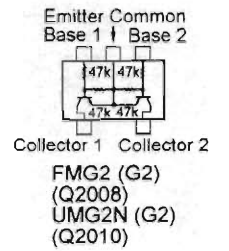
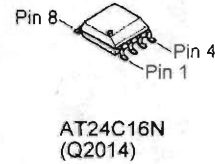
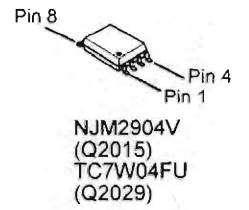
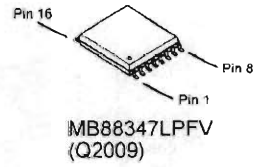

Parts List

REF.	DESCRIPTION	VALUE	WV	TOL.	MFGR'S DESIG	YAESU P/N	VERS.	LOT.	LAY ADR
*** CNTL UNIT ***									
	PCB with Components					CA1492002	TYP A1, EXP		
	PCB with Components					CA1492003	TYP A2, USA		
	PCB with Components					CA1492004	TYP A3, EXP		
	PCB with Components					CA1492005	TYP B1, EXP		
	PCB with Components					CA1492006	TYP B2, EXP		
	PCB with Components					CA1492007	TYP B3, EXP		
	PCB with Components					CA1492008	TYP C1, EXP		
	PCB with Components					CA1492009	TYP C2, EXP		
	PCB with Components					CA1492010	TYP C3, EXP		
	PCB with Components					CA1492011	TYP D1, EXP		
	PCB with Components					CA1492012	TYP D2, EXP		
	PCB with Components					CA1492013	TYP H1, AUS		
	PCB with Components					CA1492014	TYP H2, AUS		
	PCB with Components					CA1492015	TYP A2, EXP		
	Printed Circuit Board					F3578101			
	Printed Circuit Board					F3578101A		2-	
	Printed Circuit Board					F3578101B		5-	
	Printed Circuit Board					F3578101C		12-	
BT2001	LITHIUM BATTERY		3V		CR1216-1F6	Q9000627			
C 2001	CHIP CAP.	0.1uF	25V	B	GRM40B104M25PT	K22140811			
C 2002	CHIP CAP.	100pF	50V	CH	GRM39CH101J50PT	K22174235			
C 2003	AL. ELECTRO. CAP.	100uF	16V		RE3-16V101M	K40129063			
C 2004	TANTALUM CHIP CAP.	10uF	6.3V		TEMSVA0J106M-8R	K78080027			
C 2005	CHIP CAP.	0.001uF	50V	B	GRM39B102M50PT	K22174809			
C 2006	CHIP CAP.	0.001uF	50V	B	GRM39B102M50PT	K22174809			
C 2007	TANTALUM CHIP CAP.	100uF	4V		TEMSVCOG107M12R	K78060021			
C 2008	CHIP CAP.	0.001uF	50V	B	GRM39B102M50PT	K22174809			
C 2009	CHIP CAP.	0.001uF	50V	B	GRM39B102M50PT	K22174809			
C 2010	CHIP CAP.	1uF	10V	B	GRM40B105K10PT	K22100802			
C 2011	CHIP CAP.	0.047uF	16V	B	GRM39B473K16PT	K22124804			
C 2012	CHIP CAP.	0.001uF	50V	B	GRM39B102M50PT	K22174809			
C 2013	TANTALUM CHIP CAP.	4.7uF	6.3V		TEMSVA0J475M-8R	K78080017			
C 2014	CHIP CAP.	0.1uF	25V	F	GRM39F104Z25PT	K22145001			
C 2015	CHIP CAP.	0.01uF	25V	B	GRM39B103K25PT	K22144803			
C 2016	CHIP CAP.	1uF	16V	F	EMK212F105Z00T	K22121001			
C 2017	CHIP CAP.	9pF	50V	CH	GRM39CH090D50PT	K22174210			
C 2019	CHIP CAP.	22pF	50V	CH	GRM39CH220J50PT	K22174219			
C 2019	CHIP CAP.	18pF	50V	CH	GRM39CH180J50PT	K22174217		12-	
C 2020	TANTALUM CHIP CAP.	1uF	16V		TESVA1C105M1-8R	K78120009			
C 2020	TANTALUM CHIP CAP.	4.7uF	6.3V		TEMSVA0J475M-8R	K78080017		2-	
C 2021	CHIP CAP.	0.033uF	16V	R	GRM39R333K16PT	K22124801			
C 2022	CHIP CAP.	0.033uF	16V	R	GRM39R333K16PT	K22124801			
C 2023	CHIP CAP.	100pF	50V	CH	GRM39CH101J50PT	K22174235			
C 2023	CHIP CAP.	220pF	50V	CH	GRM39CH221J50PT	K22174243			2-
C 2023	CHIP CAP.	150pF	50V	CH	GRM39CH151J50PT	K22174239			23-
C 2024	CHIP CAP.	0.001uF	50V	B	GRM39B102M50PT	K22174809			
C 2025	TANTALUM CHIP CAP.	4.7uF	6.3V		TEMSVA0J475M-8R	K78080017			
C 2026	CHIP CAP.	0.033uF	16V	R	GRM39R333K16PT	K22124801			
C 2027	CHIP CAP.	0.047uF	16V	B	GRM39B473K16PT	K22124804			
C 2028	CHIP CAP.	0.01uF	25V	B	GRM39B103K25PT	K22144803			
C 2029	CHIP CAP.	0.0018uF	50V	B	GRM39B182M50PT	K22174812			
C 2030	CHIP CAP.	0.01uF	25V	B	GRM39B103K25PT	K22144803			
C 2031	CHIP CAP.	0.1uF	25V	B	GRM40B104M25PT	K22140811			
C 2032	CHIP CAP.	0.01uF	25V	B	GRM39B103K25PT	K22144803			
C 2033	TANTALUM CHIP CAP.	2.2uF	4V		TESVSP0G225M-8R	K78060025			
C 2034	CHIP CAP.	0.001uF	50V	B	GRM39B102M50PT	K22174809			
C 2035	CHIP CAP.	0.01uF	25V	B	GRM39B103K25PT	K22144803			
C 2036	CHIP CAP.	0.01uF	25V	B	GRM39B103K25PT	K22144803			
C 2037	CHIP CAP.	0.1uF	25V	B	GRM40B104M25PT	K22140811			
C 2038	CHIP CAP.	0.001uF	50V	B	GRM39B102M50PT	K22174809			

CNTL Unit

REF.	DESCRIPTION	VALUE	WV	TOL.	MFGR'S DESIG	YAESU P/N	VERS.	LOT.	LAY ADR
C 2039	AL. ELECTRO. CAP.	100uF	10V		UVV1A101MDA6CY	K40109033			
C 2040	CHIP CAP.	0. 1uF	25V	F	GRM39F104Z25PT	K22145001			
C 2040	CHIP CAP.	0. 1uF	16V	F	GRM39B104K16PT	K22124805		5-	
C 2041	CHIP CAP.	0. 001uF	50V	B	GRM39B102M50PT	K22174809			
C 2042	AL. ELECTRO. CAP.	100uF	10V		UVV1A101MDA6CY	K40109033			
C 2043	CHIP CAP.	1uF	16V	F	EMK212F105Z00T	K22121001			
C 2044	CHIP CAP.	0. 0047uF	50V	B	GRM39B472M50PT	K22174817			
C 2045	CHIP CAP.	0. 01uF	25V	B	GRM39B103K25PT	K22144803			
C 2046	CHIP CAP.	0. 01uF	25V	B	GRM39B103J25PT	K22144809			
C 2046	CHIP CAP.	0. 0033uF	50V	B	GRM39B332M50PT	K22174815		5-	
C 2047	CHIP CAP.	1uF	16V	F	EMK212F105Z00T	K22121001			
C 2048	CHIP CAP.	0. 01uF	25V	B	GRM39B103K25PT	K22144803			
C 2049	TANTALUM CHIP CAP.	4. 7uF	6. 3V		TEMSVA0J475M-8R	K78080017			
C 2050	CHIP CAP.	0. 047uF	16V	B	GRM39B473K16PT	K22124804			
C 2051	CHIP CAP.	0. 001uF	50V	B	GRM39B102M50PT	K22174809			
C 2052	TANTALUM CHIP CAP.	22uF	4V		TEMSVA0G226M-8R	K78060023			
C 2053	CHIP CAP.	0. 0047uF	50V	B	GRM39B472M50PT	K22174817			
C 2054	CHIP CAP.	0. 001uF	50V	B	GRM39B102M50PT	K22174809			
C 2055	TANTALUM CHIP CAP.	4. 7uF	6. 3V		TEMSVA0J475M-8R	K78080017			
C 2055	TANTALUM CHIP CAP.	1uF	25V		TEMSVA1E105M-8R	K78140013		5-	
C 2056	CHIP CAP.	0. 001uF	50V	B	GRM39B102M50PT	K22174809			
C 2057	TANTALUM CHIP CAP.	10uF	16V		TEMSVB21C106M-8R	K78120025			
C 2059	CHIP CAP.	0. 033uF	16V	R	GRM39R333K16PT	K22124801			
C 2060	CHIP CAP.	0. 1uF	25V	B	GRM40B104M25PT	K22140811			
C 2061	CHIP CAP.	180pF	50V	CH	GRM39CH181J50PT	K22174241			
C 2062	CHIP CAP.	0. 1uF	25V	B	GRM40B104M25PT	K22140811			
C 2063	TANTALUM CHIP CAP.	22uF	4V		TEMSVA0G226M-8R	K78060023			
C 2064	CHIP CAP.	100pF	50V	CH	GRM39CH101J50PT	K22174235			
C 2065	CHIP CAP.	0. 001uF	50V	B	GRM39B102M50PT	K22174809			
C 2066	CHIP CAP.	0. 001uF	50V	B	GRM39B102M50PT	K22174809			
C 2067	CHIP CAP.	0. 001uF	50V	B	GRM39B102M50PT	K22174809			
C 2068	CHIP CAP.	1uH	16V	F	EMK212F105Z00T	K22121001			
C 2068	TANTALUM CHIP CAP.	3. 3uF	4V		TESVSP0G335M-8R	K78060032		23-	
C 2069	CHIP CAP.	100pF	50V	CH	GRM40CH101J50PT	K22170235			
C 2069	CHIP CAP.	100pF	50V	CH	GRM39CH101J50PT	K22174235		5-	
C 2070	CHIP CAP.	100pF	50V	CH	GRM40CH101J50PT	K22170235			
C 2070	CHIP CAP.	100pF	50V	CH	GRM39CH101J50PT	K22174235		5-	
C 2071	CHIP CAP.	100pF	50V	CH	GRM40CH101J50PT	K22170235			
C 2071	CHIP CAP.	100pF	50V	CH	GRM39CH101J50PT	K22174235		5-	
C 2072	CHIP CAP.	100pF	50V	CH	GRM40CH101J50PT	K22170235			
C 2072	CHIP CAP.	100pF	50V	CH	GRM39CH101J50PT	K22174235		5-	
C 2073	CHIP CAP.	0. 001uF	50V	B	GRM39B102M50PT	K22174809			
C 2074	CHIP CAP.	5pF	50V	CH	GRM39CH050C50PT	K22174206		12-	
D 2001	DIODE				1SS319 TE85R	G2070080			
D 2001	DIODE				1SS377 TE85L	G2070512		8-	
D 2001	DIODE				1SS391 TE85L	G2070510		10-	
D 2001	DIODE				1SS377 TE85L	G2070512		12-	
D 2002	DIODE				DA204U T106	G2070242			
D 2003	LED				LUB1006D	G2090619			
D 2003	LED				LUB1006D1	G2090681		14-	
D 2004	LED				CL-155UR/G-D-T	G2070278			
D 2005	DIODE				MA111- (TX)	G2070338			
D 2006	DIODE				DA204U T106	G2070242			
D 2007	DIODE				DA221 TL	G2070178			
D 2008	DIODE				DAN222 TL	G2070174			
D 2009	DIODE				MA111- (TX)	G2070338			
D 2010	DIODE				MA729- (TX)	G2070320			
D 2011	DIODE				RD6. 8UMB2-T1B	G2070438			
D 2012	DIODE				DTZ5. 1A TT11	G2070244			
D 2013	DIODE				DAN222 TL	G2070174			
DS2001	LCD				T415014	G6090118			

REF.	DESCRIPTION	VALUE	WV	TOL.	MFGR'S DESIG	YAESU P/N	VERS.	LOT.	LAY ADR
J 2001	CONNECTOR				CPB8618-0551	P0091010			
J 2002	CONNECTOR				AXN420C330P	P0091096			
J 2003	CONNECTOR				HSJ1594-010055	P1090896			
L 2001	M. RFC	150uH			FLC32T-151J	L1690229			
L 2001	M. RFC	100uH			FLC32T-101J	L1690227		7-	
L 2001	M. RFC	150uH			FLC32T-151J	L1690229		12-	
MC2001	MIC ELEMENT				WM-54BW	M3290026			
MC2001	MIC ELEMENT				EM-100PT	M3290029		6-	
Q 2001	TRANSISTOR				DTC143ZE TL	G3070102			
Q 2002	IC				S-81233SG-QF-T1	G1091936			
Q 2003	IC				S-80730SN-DT-T1	G1091875			
Q 2004	TRANSISTOR				2SC4116GR TE85R	G3341167G			
Q 2005	TRANSISTOR				2SB1132 T100 Q	G3211327Q			
Q 2006	TRANSISTOR				FMW1 T98	G3070009			
Q 2007	TRANSISTOR				DTC144EU T107	G3070041			
Q 2007	TRANSISTOR				DTC144EE TL	G3070075		12-	
Q 2008	TRANSISTOR				FMG2 T99	G3070015			
Q 2009	IC				MB88347LPFV-G-BND-EF	G1092066			
Q 2010	TRANSISTOR				UMG2N TL	G3070088			
Q 2011	TRANSISTOR				2SC4116GR TE85R	G3341167G			
Q 2011	TRANSISTOR				2SC4537TR	G3345377		7-	
Q 2012	TRANSISTOR				UMD2N TR	G3070076			
Q 2013	TRANSISTOR				UMD2N TR	G3070076			
Q 2014	IC				AT24C16N-10S1-2.7	G1091743			
Q 2015	IC				NJM2904V-TE1	G1091677			
Q 2016	IC				HD6433876UA30X	G1092409	DST AUS	8-	
Q 2016	IC				HD6433876UA30X	G1092409	DST EXP	8-	
Q 2016	IC				HD6433876UA68X	G1092698	DST USA	23-	
Q 2017	TRANSISTOR				DTA144EU T106	G3070079			
Q 2018	IC				NJM3403AV (TE1)	G1092215			
Q 2019	IC				BU4021BF-T1	G1092127			
Q 2020	TRANSISTOR				2SC4116GR TE85R	G3341167G			
Q 2021	TRANSISTOR				2SB1132 T100 Q	G3211327Q			
Q 2022	IC				TDA7233D-TR	G1091112			
Q 2023	TRANSISTOR				DTC144EE TL	G3070075			
Q 2024	IC				TC7S66FU TE85R	G1092116			
Q 2025	TRANSISTOR				UMD2N TR	G3070076			
Q 2026	TRANSISTOR				DTC143ZE TL	G3070102			
Q 2027	TRANSISTOR				2SC4116GR TE85R	G3341167G			
Q 2028	IC				TC7S66FU TE85R	G1092116			
Q 2029	IC				TC7W04FU TE12R	G1091539		12-	
R 2001	CHIP RES.	33K	1/16W	5%	RMC1/16 333JATP	J24185333			
R 2002	CHIP RES.	100K	1/16W	5%	RMC1/16 104JATP	J24185104			
R 2003	CHIP RES.	4.7K	1/16W	5%	RMC1/16 472JATP	J24185472			
R 2004	CHIP RES.	15K	1/16W	5%	RMC1/16 153JATP	J24185153			
R 2005	CHIP RES.	2.2K	1/16W	5%	RMC1/16 222JATP	J24185222			
R 2006	CHIP RES.	390K	1/16W	5%	RMC1/16 394JATP	J24185394			
R 2007	CHIP RES.	330	1/16W	5%	RMC1/16 331JATP	J24185331			
R 2008	CHIP RES.	150	1/16W	5%	RMC1/16 151JATP	J24185151			
R 2009	CHIP RES.	2.2K	1/16W	5%	RMC1/16 222JATP	J24185222			
R 2010	CHIP RES.	150	1/16W	5%	RMC1/16 151JATP	J24185151			
R 2011	CHIP RES.	330K	1/16W	5%	RMC1/16 334JATP	J24185334			
R 2011	CHIP RES.	330K	1/16W	0.5%	RR0816R-334-D	J24189172		4-	
R 2012	CHIP RES.	2.2K	1/16W	5%	RMC1/16 222JATP	J24185222			
R 2013	CHIP RES.	10K	1/16W	5%	RMC1/16 103JATP	J24185103			
R 2014	CHIP RES.	68K	1/16W	5%	RMC1/16 683JATP	J24185683			
R 2014	CHIP RES.	68K	1/16W	0.5%	RR0816R-683-D	J24189171		4-	
R 2015	CHIP RES.	68K	1/16W	5%	RMC1/16 683JATP	J24185683			
R 2016	CHIP RES.	100K	1/16W	5%	RMC1/16 104JATP	J24185104			
R 2017	CHIP RES.	100K	1/16W	5%	RMC1/16 104JATP	J24185104			
R 2019	CHIP RES.	1M	1/16W	5%	RMC1/16 105JATP	J24185105			

CNTL Unit

REF.	DESCRIPTION	VALUE	WV	TOL.	MFGR'S DESIG	YAESU P/N	VERS.	LOT.	LAY ADR
R 2020	CHIP RES.	22K	1/16W	5%	RMC1/16 223JATP	J24185223			
R 2020	CHIP RES.	100K	1/16W	5%	RMC1/16 104JATP	J24185104			
R 2020	CHIP RES.	10K	1/16W	5%	RMC1/16 103JATP	J24185103		7-	
R 2021	CHIP RES.	22K	1/16W	5%	RMC1/16 223JATP	J24185223		12-	
R 2022	CHIP RES.	33K	1/16W	5%	RMC1/16 333JATP	J24185333			
R 2022	CHIP RES.	100K	1/16W	5%	RMC1/16 104JATP	J24185104		23-	
R 2023	CHIP RES.	47K	1/16W	5%	RMC1/16 473JATP	J24185473			
R 2024	CHIP RES.	22K	1/16W	5%	RMC1/16 223JATP	J24185223			
R 2024	CHIP RES.	33K	1/16W	5%	RMC1/16 333JATP	J24185333		2-	
R 2025	CHIP RES.	47K	1/16W	5%	RMC1/16 473JATP	J24185473			
R 2025	CHIP RES.	100K	1/16W	5%	RMC1/16 104JATP	J24185104		2-	
R 2025	CHIP RES.	47K	1/16W	5%	RMC1/16 473JATP	J24185473		3-	
R 2026	CHIP RES.	47K	1/16W	5%	RMC1/16 473JATP	J24185473			
R 2027	CHIP RES.	2. 2M	1/16W	5%	RMC1/16 225JATP	J24185225			
R 2028	CHIP RES.	180K	1/16W	5%	RMC1/16 184JATP	J24185184			
R 2029	CHIP RES.	4. 7K	1/16W	5%	RMC1/16 472JATP	J24185472			
R 2030	CHIP RES.	4. 7K	1/16W	5%	RMC1/16 472JATP	J24185472			
R 2031	CHIP RES.	33K	1/16W	5%	RMC1/16 333JATP	J24185333			
R 2032	CHIP RES.	47K	1/16W	5%	RMC1/16 473JATP	J24185473			
R 2033	CHIP RES.	100K	1/16W	5%	RMC1/16 104JATP	J24185104			
R 2034	CHIP RES.	3. 9K	1/16W	5%	RMC1/16 392JATP	J24185392			
R 2035	CHIP RES.	33K	1/16W	5%	RMC1/16 333JATP	J24185333			
R 2036	CHIP RES.	47K	1/16W	5%	RMC1/16 473JATP	J24185473			
R 2037	CHIP RES.	470K	1/16W	5%	RMC1/16 474JATP	J24185474			
R 2038	CHIP RES.	4. 7K	1/16W	5%	RMC1/16 472JATP	J24185472			
R 2039	CHIP RES.	100K	1/16W	5%	RMC1/16 104JATP	J24185104			
R 2040	CHIP RES.	4. 7K	1/16W	5%	RMC1/16 472JATP	J24185472			
R 2041	CHIP RES.	4. 7K	1/16W	5%	RMC1/16 472JATP	J24185472			
R 2041	CHIP RES.	6. 8K	1/16W	5%	RMC1/16 682JATP	J24185682		5-	
R 2042	CHIP RES.	4. 7K	1/16W	5%	RMC1/16 472JATP	J24185472			
R 2043	CHIP RES.	33K	1/16W	5%	RMC1/16 333JATP	J24185333			
R 2044	CHIP RES.	10K	1/16W	5%	RMC1/16 103JATP	J24185103			
R 2045	CHIP RES.	10K	1/16W	5%	RMC1/16 103JATP	J24185103			
R 2046	CHIP RES.	10K	1/16W	5%	RMC1/16 103JATP	J24185103			
R 2048	CHIP RES.	0	1/16W	5%	RMC1/16 000JATP	J24185000			
R 2049	CHIP RES.	100K	1/16W	5%	RMC1/16 104JATP	J24185104			
R 2050	CHIP RES.	100K	1/16W	5%	RMC1/16 104JATP	J24185104			
R 2051	CHIP RES.	100K	1/16W	5%	RMC1/16 104JATP	J24185104			
R 2052	CHIP RES.	100K	1/16W	5%	RMC1/16 104JATP	J24185104			
R 2053	CHIP RES.	220K	1/16W	5%	RMC1/16 224JATP	J24185224			
R 2054	CHIP RES.	68K	1/16W	5%	RMC1/16 683JATP	J24185683			
R 2054	CHIP RES.	10K	1/16W	5%	RMC1/16 103JATP	J24185103		5-	
R 2056	CHIP RES.	1K	1/16W	5%	RMC1/16 102JATP	J24185102			
R 2057	CHIP RES.	0	1/16W	5%	RMC1/16 000JATP	J24185000		-4	
R 2059	CHIP RES.	2. 2K	1/16W	5%	RMC1/16 222JATP	J24185222			
R 2060	CHIP RES.	15K	1/16W	5%	RMC1/16 153JATP	J24185153			
R 2061	CHIP RES.	1K	1/16W	5%	RMC1/16 102JATP	J24185102			
R 2062	CHIP RES.	22K	1/16W	5%	RMC1/16 223JATP	J24185223			
R 2063	CHIP RES.	47K	1/16W	5%	RMC1/16 473JATP	J24185473			
R 2064	CHIP RES.	47K	1/16W	5%	RMC1/16 473JATP	J24185473			
R 2065	CHIP RES.	22K	1/16W	5%	RMC1/16 223JATP	J24185223			
R 2065	CHIP RES.	33K	1/16W	5%	RMC1/16 333JATP	J24185333		2-	
R 2066	CHIP RES.	10	1/16W	5%	RMC1/16 100JATP	J24185100			
R 2067	CHIP RES.	4. 7K	1/16W	5%	RMC1/16 472JATP	J24185472			
R 2069	CHIP RES.	47K	1/16W	5%	RMC1/16 473JATP	J24185473			
R 2070	CHIP RES.	10K	1/16W	5%	RMC1/16 103JATP	J24185103			
R 2071	CHIP RES.	10K	1/16W	5%	RMC1/16 103JATP	J24185103			
R 2072	CHIP RES.	100	1/16W	5%	RMC1/16 101JATP	J24185101			
R 2073	CHIP RES.	470K	1/16W	5%	RMC1/16 474JATP	J24185474			
R 2074	CHIP RES.	4. 7K	1/16W	5%	RMC1/16 472JATP	J24185472			
R 2075	CHIP RES.	2. 2K	1/16W	5%	RMC1/16 222JATP	J24185222			

REF.	DESCRIPTION	VALUE	WV	TOL.	MFGR'S DESIG	YAESU P/N	VERS.	LOT.	LAY ADR
R 2076	CHIP RES.	4. 7K	1/16W	5%	RMC1/16 472JATP	J24185472			
R 2077	CHIP RES.	5. 6K	1/16W	5%	RMC1/16 562JATP	J24185562			
R 2078	CHIP RES.	5. 6K	1/16W	5%	RMC1/16 562JATP	J24185562			
R 2079	CHIP RES.	180K	1/16W	5%	RMC1/16 184JATP	J24185184			
R 2080	CHIP RES.	47K	1/16W	5%	RMC1/16 473JATP	J24185473			
R 2081	CHIP RES.	10K	1/16W	5%	RMC1/16 103JATP	J24185103			
R 2082	CHIP RES.	10K	1/16W	5%	RMC1/16 103JATP	J24185103			
R 2083	CHIP RES.	270K	1/16W	5%	RMC1/16 274JATP	J24185274			
R 2084	CHIP RES.	470	1/16W	5%	RMC1/16 471JATP	J24185471			
R 2085	CHIP RES.	2. 2K	1/16W	5%	RMC1/16 222JATP	J24185222			
R 2086	CHIP RES.	47K	1/16W	5%	RMC1/16 473JATP	J24185473			
R 2087	CHIP RES.	22K	1/16W	5%	RMC1/16 223JATP	J24185223			
R 2088	CHIP RES.	5. 6K	1/16W	5%	RMC1/16 562JATP	J24185562			
R 2089	CHIP RES.	10K	1/16W	5%	RMC1/16 103JATP	J24185103			
R 2090	CHIP RES.	8. 2K	1/16W	5%	RMC1/16 822JATP	J24185822			
R 2091	CHIP RES.	15K	1/16W	5%	RMC1/16 153JATP	J24185153			
R 2092	CHIP RES.	2. 2M	1/16W	5%	RMC1/16 225JATP	J24185225			
R 2093	CHIP RES.	180K	1/16W	5%	RMC1/16 184JATP	J24185184			
R 2094	CHIP RES.	10K	1/16W	5%	RMC1/16 103JATP	J24185103			
R 2094	CHIP RES.	56K	1/16W	5%	RMC1/16 563JATP	J24185563		2-	
R 2095	CHIP RES.	560	1/16W	5%	RMC1/16 561JATP	J24185561			
R 2096	CHIP RES.	4. 7K	1/16W	5%	RMC1/16 472JATP	J24185472			
R 2097	CHIP RES.	4. 7K	1/16W	5%	RMC1/16 472JATP	J24185472			
R 2098	CHIP RES.	10K	1/16W	5%	RMC1/16 103JATP	J24185103			
R 2099	CHIP RES.	100K	1/16W	5%	RMC1/16 104JATP	J24185104			
R 2100	CHIP RES.	150K	1/16W	5%	RMC1/16 154JATP	J24185154			
R 2101	CHIP RES.	15K	1/16W	5%	RMC1/16 153JATP	J24185153			
R 2102	CHIP RES.	56K	1/16W	5%	RMC1/16 563JATP	J24185563		12-	
R 2103	CHIP RES.	10K	1/16W	5%	RMC1/16 103JATP	J24185103		12-	
S 2002	TACT SWITCH				JPM1990-0302	N5090093			
S 2003	TACT SWITCH				JPM1990-0302	N5090093			
S 2004	TACT SWITCH				JPM1990-0302	N5090093			
SP2001	SPEAKER	8-ohm	0. 5W		T032S23Y2610 0. 5W/80HM	M4090109			
TH2001	THERMISTER				TBPS1R473K475H5Q	G9090068			
TH2002	THERMISTER				TBPS1R473K475H5Q	G9090068			
VR2001	POT.	10K			EVM-1XSX50B14	J51800103			
VR2001	POT.	10K			EVM-2WSX80B14	J51822103		24-	
X 2001	XTAL	3. 579545MHz				H0103127			
	SHIELD SHEET					R0522580			
	HOLDER RUBBER (MIC)					R3152460A			
	STUD					R6153690			
	MYLAR (R1)					R7150420			

CNTL Unit

Notes:

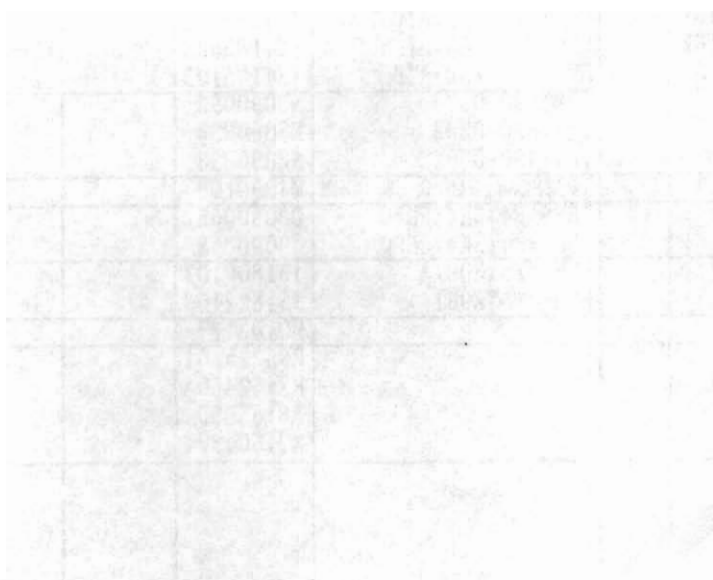

Circuit Diagram

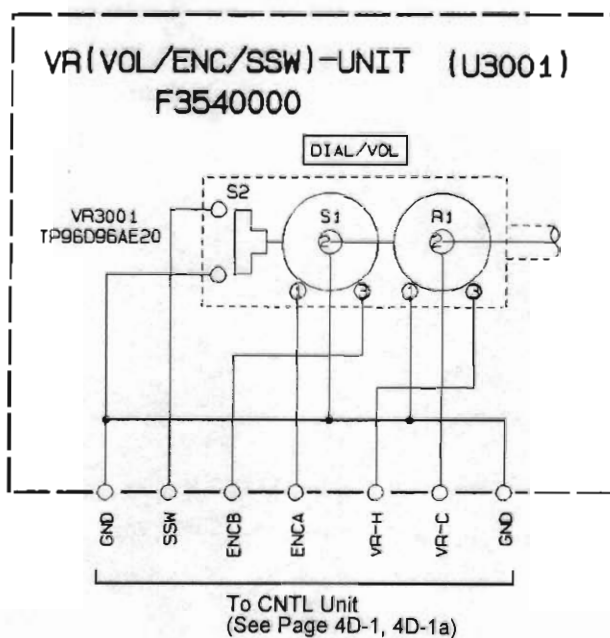

Parts Layout



Component Side

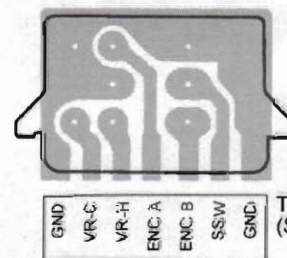

Solder Side

To CNTL Unit
(See Page 4D-3,
4D-3a, 4D-3b)

Parts List

REF.	DESCRIPTION	VALUE	WV	TOL.	MFR'S DESIG	YAESU P/N	VERS.	LOT.	LAY ADR
*** VR UNIT ***									
	PCB with Components					CA1577001			
	Printed Circuit Board					F3540000			
VR3001	ROTARY CODE S. W.				TP96D96AE20	Q9000640			

VR Unit

Notes:



FTT-11 DTMF Paging Keypad

Circuit Diagram

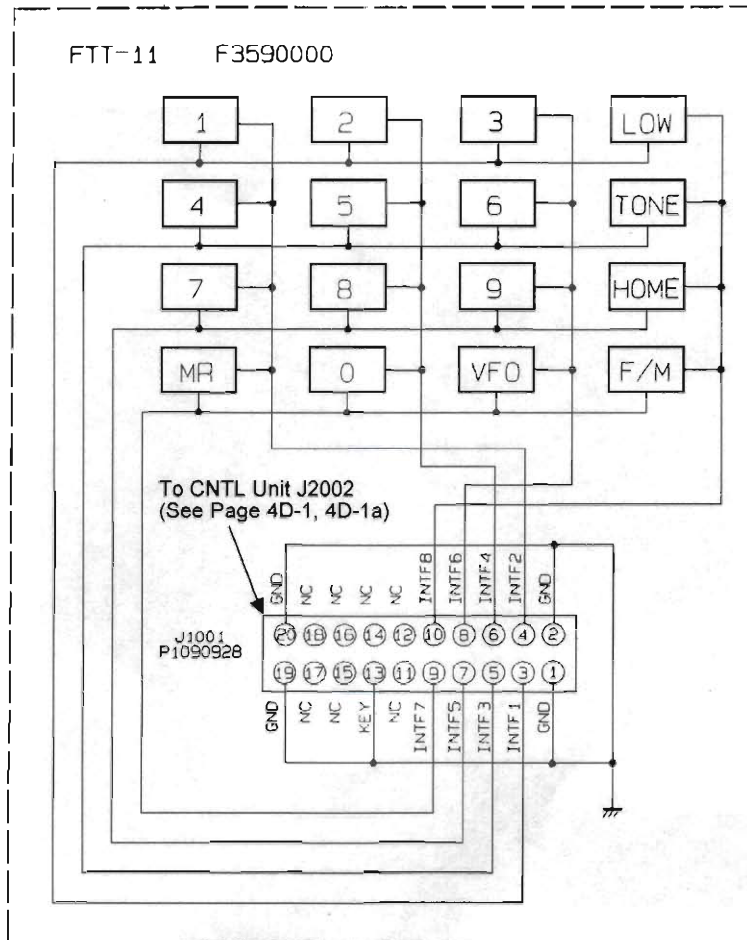

Parts Layout

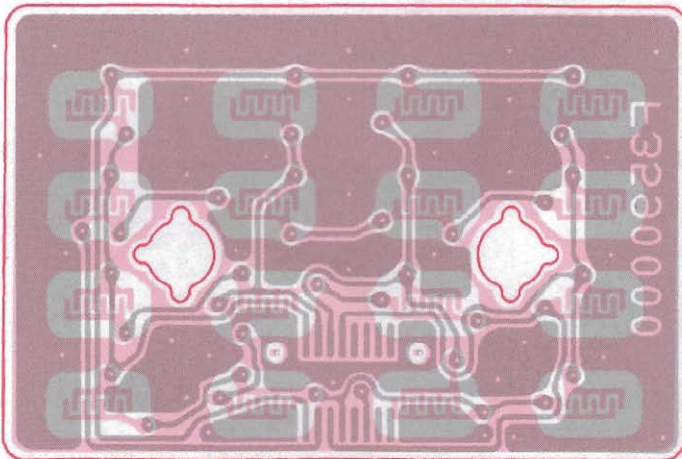

Keypad Side

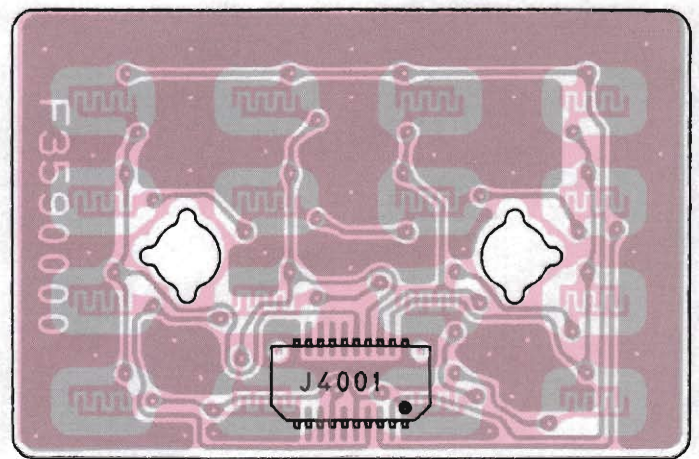

Connector Side

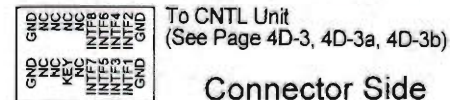

Parts List

REF.	DESCRIPTION	VALUE	WV	TOL.	MFGR'S DESIG	YAESU P/N	VERS.	LOT.	LAY ADR
*** FTT-11 ***									
	PCB with Components					F3590000			
J 1001	CONNECTOR				AXN320C038P	P1090928			
	O RING (KEY BLOCK)					R3154260			

FTT-11 DTMF Paging Keypad

Notes:

FTT-12 Digital Voice Keypad

Circuit Diagram

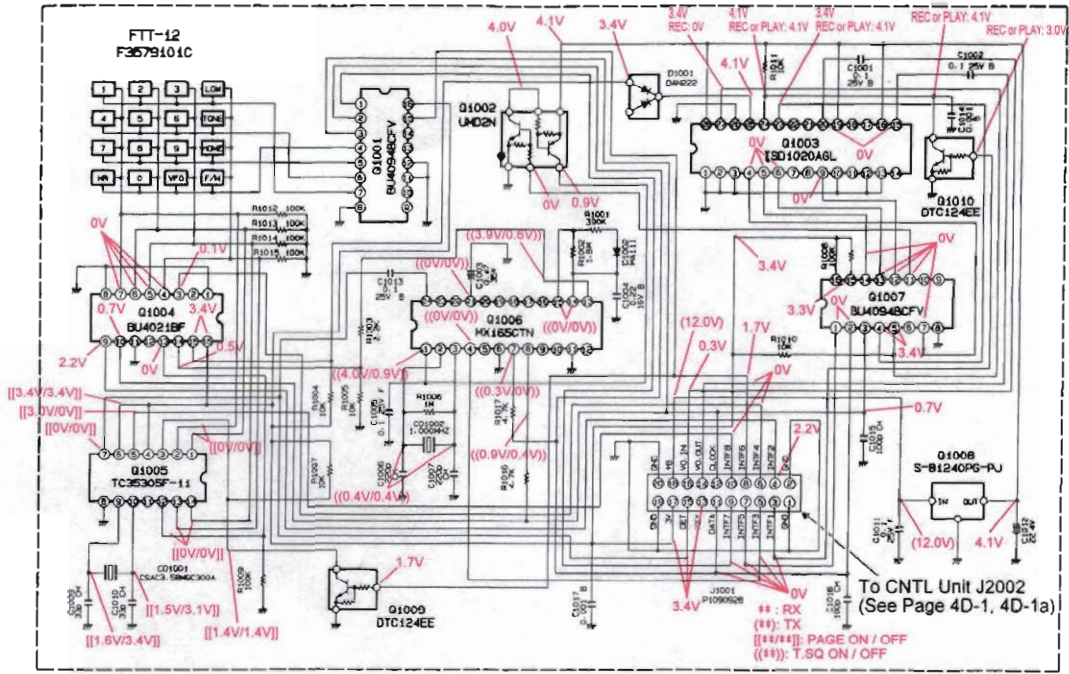

Parts Layout

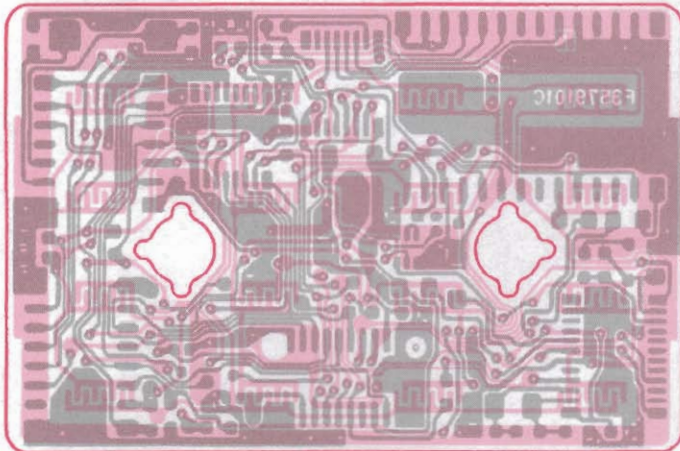

Keypad Side

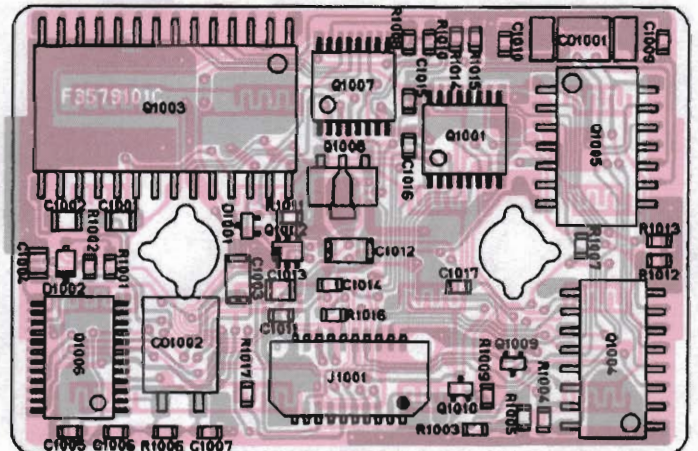

Chip Side

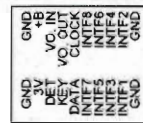

To CNTL Unit
(See Page 4D-3, 4D-3a, 4D-3b)

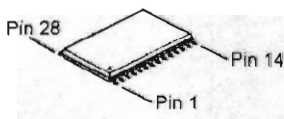

ISD1020AGL
(Q1003)

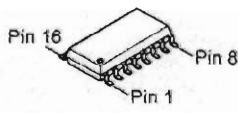

BU4021BF
(Q1004)

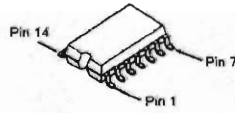

TC35305F
(Q1005)

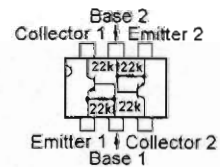

UMD2N (D2)
(Q1002)

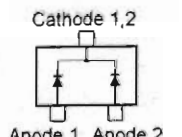

DAN222 (N)
(D1001)

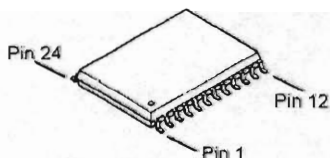

MX165CTN
(Q1006)

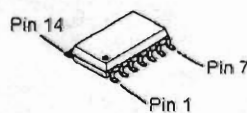

BU4094BCFV
(Q1001, 1007)



S-81240PG (PJ)
(Q1008)

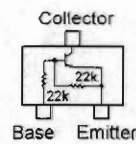

DTC124EE (25)
(Q1009, 1010)

FTT-12 Digital Voice Keypad

Notes:

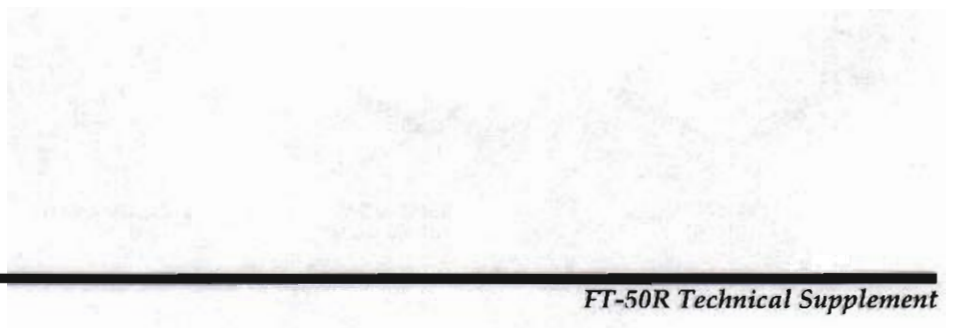
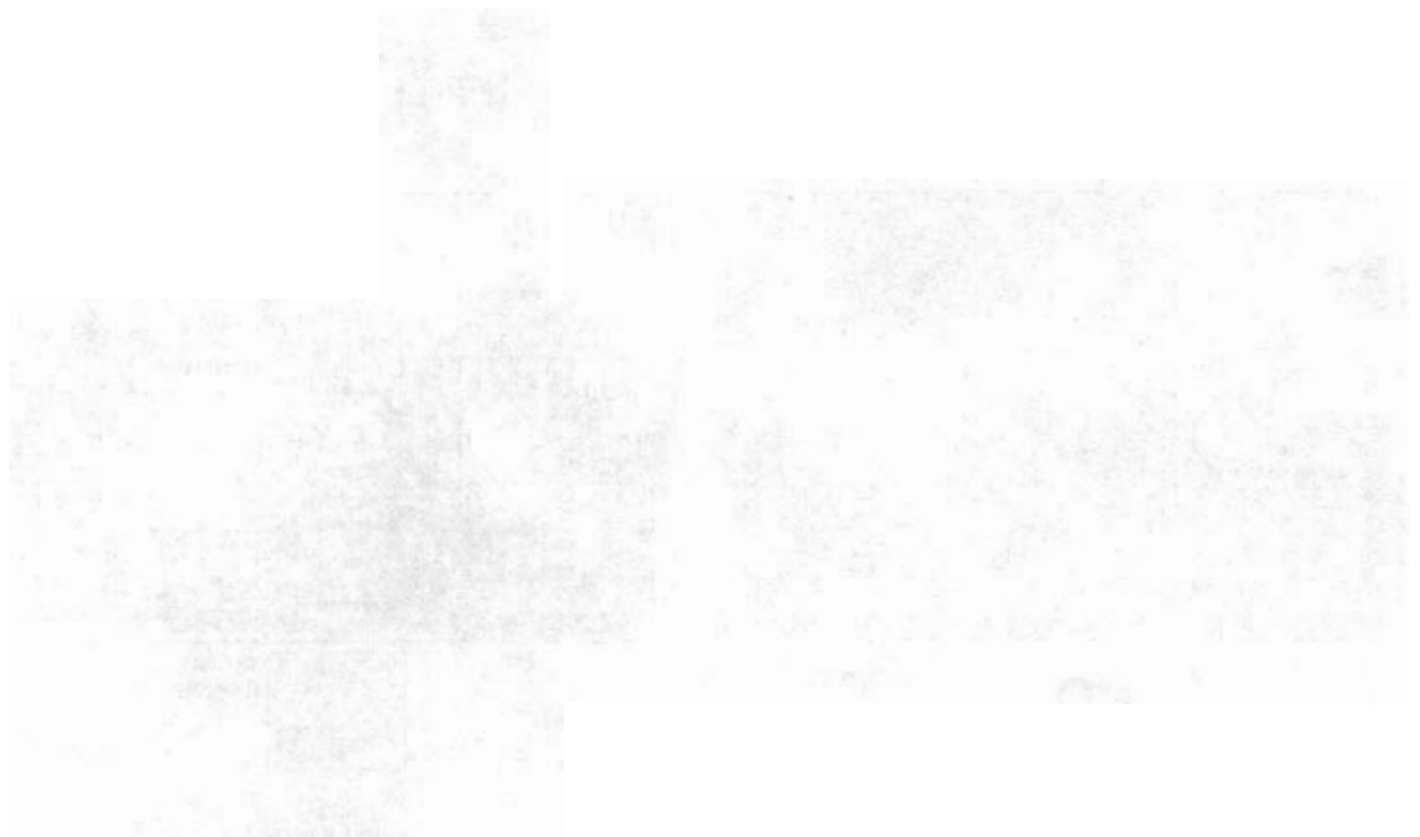

FTT-12 Digital Voice Keypad

Parts List

REF.	DESCRIPTION	VALUE	WV	TOL.	MFR'S DESIG	YAESU P/N	VERS.	LOT.	LAY ADR
*** FTT-12 ***									
PCB with Components						F3579101C			
C 1001	CHIP CAP.	0. 1uF	25V	B	GRM40B104M25PT	K22140811			
C 1002	CHIP CAP.	0. 1uF	25V	B	GRM40B104M25PT	K22140811			
C 1003	TANTALUM CHIP CAP.	0. 47uF	35V		TEMSVA1V474M-8R	K78160029			
C 1004	CHIP CAP.	0. 1uF	25V	B	GRM40B104M25PT	K22140811			
C 1004	CHIP CAP.	0. 22uF	16V	B	GRM40B224M16PT	K22120806		3-	
C 1005	CHIP CAP.	0. 1uF	25V	F	GRM39F104Z25PT	K22145001			
C 1006	CHIP CAP.	220pF	50V	CH	GRM39CH221J50PT	K22174243			
C 1007	CHIP CAP.	220pF	50V	CH	GRM39CH221J50PT	K22174243			
C 1009	CHIP CAP.	33pF	50V	CH	GRM39CH330J50PT	K22174223			
C 1010	CHIP CAP.	33pF	50V	CH	GRM39CH330J50PT	K22174223			
C 1011	CHIP CAP.	0. 1uF	25V	F	GRM39F104Z25PT	K22145001			
C 1012	TANTALUM CHIP CAP.	22uF	4V		TEMSVAOG226M-8R	K78060023			
C 1013	CHIP CAP.	0. 1uF	25V	B	GRM40B104M25PT	K22140811			
C 1014	CHIP CAP.	0. 001uF	50V	B	GRM39B102M50PT	K22174809			
C 1015	CHIP CAP.	100pF	50V	CH	GRM39CH101J50PT	K22174235			
C 1016	CHIP CAP.	100pF	50V	CH	GRM39CH101J50PT	K22174235			
C 1017	CHIP CAP.	0. 001uF	50V	B	GRM39B102M50PT	K22174809			
CO1001	CERAMIC OSC				CSAC3. 58MGC300A-TC	H7900790			
CO1002	CERAMIC OSC				CSBF1000J221T-TC01	H7900950			
D 1001	DIODE				DAN222 TL	G2070174			
D 1002	DIODE				MA111- (TX)	G2070338			
J 1001	CONNECTOR				AXN320C038P	P1090928			
Q 1001	IC				BU4094BCFV-E1	G1092128			
Q 1002	TRANSISTOR				UMD2N TR	G3070076			
Q 1003	IC				ISD1020AGL-R	G1092076			
Q 1004	IC				BU4021BF-T1	G1092127			
Q 1005	IC				TC35305F-11 TP2	G1091177			
Q 1006	IC				MX165CTN-TR	G1092117			
Q 1007	IC				BU4094BCFV-E1	G1092128			
Q 1008	IC				S-81237PG-PE-T1	G1092065			
Q 1008	IC				S-81240PG-PJ-T1	G1092276		3-	
Q 1009	TRANSISTOR				DTC124EE TL	G3070109			
Q 1010	TRANSISTOR				DTC124EE TL	G3070109			
R 1001	CHIP RES.	220K	1/16W	5%	RMC1/16 224JATP	J24185224			
R 1001	CHIP RES.	390K	1/16W	5%	RMC1/16 394JATP	J24185394		3-	
R 1002	CHIP RES.	3. 3M	1/16W	5%	RMC1/16 335JATP	J24185335			
R 1002	CHIP RES.	1. 8M	1/16W	5%	RMC1/16 185JATP	J24185185		3-	
R 1003	CHIP RES.	2. 2K	1/16W	5%	RMC1/16 222JATP	J24185222			
R 1004	CHIP RES.	10K	1/16W	5%	RMC1/16 103JATP	J24185103			
R 1005	CHIP RES.	10K	1/16W	5%	RMC1/16 103JATP	J24185103			
R 1006	CHIP RES.	1M	1/16W	5%	RMC1/16 105JATP	J24185105			
R 1007	CHIP RES.	10K	1/16W	5%	RMC1/16 103JATP	J24185103			
R 1008	CHIP RES.	100K	1/16W	5%	RMC1/16 104JATP	J24185104			
R 1009	CHIP RES.	100K	1/16W	5%	RMC1/16 104JATP	J24185104			
R 1010	CHIP RES.	10K	1/16W	5%	RMC1/16 103JATP	J24185103			
R 1011	CHIP RES.	10K	1/16W	5%	RMC1/16 103JATP	J24185103			
R 1012	CHIP RES.	100K	1/16W	5%	RMC1/16 104JATP	J24185104			
R 1013	CHIP RES.	100K	1/16W	5%	RMC1/16 104JATP	J24185104			
R 1014	CHIP RES.	100K	1/16W	5%	RMC1/16 104JATP	J24185104			
R 1015	CHIP RES.	100K	1/16W	5%	RMC1/16 104JATP	J24185104			
R 1016	CHIP RES.	4. 7K	1/16W	5%	RMC1/16 472JATP	J24185472			
R 1017	CHIP RES.	4. 7K	1/16W	5%	RMC1/16 472JATP	J24185472			
	SHIELD SHEET (16KEY)					R0153000		2-	
	O RING (KEY BLOCK)					R3154260			
	SEAL					R8402030			

FTT-12 Digital Voice Keypad

Notes: