

**Uniden®**

**BC246T**

**OWNER'S**

**MANUAL**

**OWNER'S MANUAL**

---

---

# Precautions

---

---

Before you use this scanner, please read and observe the following.

## IMPORTANT!

This scanning radio has been manufactured so that it will not tune to the radio frequencies assigned by the FCC for cellular telephone usage. The Electronic Communications Privacy Act of 1986, as amended, makes it a federal crime to intentionally intercept cellular or cordless telephone transmissions or to market this radio when altered to receive them. The installation, possession, or use of this scanning radio in a motor vehicle may be prohibited, regulated, or require a permit in certain states, cities, and/or local jurisdictions. Your local law enforcement officials should be able to provide you with information regarding the laws in your community.

Changes or modifications to this product not expressly approved by Uniden, or operation of this product in any way other than as detailed by this Operating Guide, could void your authority to operate this product.

## EARPHONE WARNING!

Be sure to use only a monaural earphone with this scanner. You can also use an optional 32  $\Omega$  stereo headset. Use of an incorrect earphone or stereo headset might be potentially hazardous to your hearing. The output of the phone jack is monaural, but you will hear it in both headphones of a stereo headset.

Set the volume to a comfortable audio level coming from the speaker before plugging in the monaural earphone or a stereo headset of the proper impedance (32  $\Omega$ ). Otherwise, you might experience some discomfort or possible hearing damage if the volume suddenly becomes too loud because of the volume control or squelch control setting. This might be particularly true of the type of earphone that is placed in the ear canal.

---

---

## **WARNING!**

Uniden **does not** represent this unit to be waterproof. To reduce the risk of fire or electrical shock, **do not** expose this unit to rain or moisture.

*Motorola®*, *SMARTNET®*, *PL®*, *Private Line®*, *DPL®*, *Digital Private Line®*, and *PRIVACY PLUS®* are registered trademarks of Motorola, Inc.

*LTR®* is a registered trademark of E.F. Johnson Co.

*EDACS®* is a registered trademark of M/A-COM Private Radio Systems, Inc.

*Uniden®* and *Bearcat®* are registered trademarks of Uniden America Corporation.

*TrunkTracker™*, *Trunk Tracking™*, and *Close Call™* are proprietary trademarks of Uniden America Corporation.

*Other trademarks used throughout this manual are the property of their respective holders.*

---

---

# Contents

---

---

|   |    |
|---|----|
| <b>The FCC Wants You to Know</b> .....                        | 8  |
| Scanning Legally .....  | 8  |
| <b>Introduction</b> .....                                     | 10 |
| <b>Feature Highlights</b> .....                               | 12 |
| About This Manual .....                                       | 16 |
| How the Scanner's Controls Are Represented in This Manual ... | 16 |
| Entering Text .....   | 17 |
| <b>Understanding Scanning</b> .....                           | 18 |
| Understanding the Scanner's Memory .....                      | 18 |
| What is Scanning? .....                                       | 18 |
| What is Searching? .....                                      | 19 |
| What is CTCSS/DCS? .....                                      | 19 |
| Conventional Scanning .....                                   | 21 |
| Simplex Operation .....                                       | 21 |
| Repeater Operation .....                                      | 22 |
| What is Trunk Tracking? .....                                 | 22 |
| Trunked Scanning .....  | 23 |
| Types of Trunking Systems .....                               | 24 |
| Motorola Trunking .....                                       | 24 |
| EDACS Trunking .....  | 25 |
| LTR Trunking .....  | 26 |
| Where To Get More Information .....                           | 27 |
| Information On The Internet .....                             | 27 |
| <b>Included With Your Scanner</b> .....                       | 29 |
| <b>Setting Up Your Scanner</b> .....                          | 30 |
| Using Internal Batteries .....                                | 30 |
| Using Rechargeable Batteries .....                            | 32 |
| Using AC Power .....  | 33 |
| Connecting the Antenna .....                                  | 33 |
| Connecting an Optional Antenna .....                          | 33 |
| Connecting an Earphone/Headphone .....                        | 34 |
| Connecting an Extension Speaker .....                         | 34 |
| Attaching the Belt Clip .....                                 | 34 |
| Attaching the Wrist Strap .....                               | 35 |
| Installing the Demo Software .....                            | 35 |
| A Look At The Keypad .....                                    | 36 |
| A Look At The Display .....                                   | 39 |
| Using Menu .....  | 40 |
| Using Func .....  | 40 |
| Using the Scroll Control .....                                | 40 |
| <b>Basic Operation</b> .....                                  | 41 |
| Turning On the Scanner and Setting the Squelch .....          | 41 |
| Scanning Systems .....  | 41 |
| Preprogrammed System Tips .....                               | 42 |
| Selecting Systems to Scan .....                               | 42 |
| Selecting System Channel Groups .....                         | 42 |
| Locking/Unlocking Systems .....                               | 43 |
| Locking/Unlocking Channels .....                              | 43 |
| ID Scan/ID Search Mode .....                                  | 43 |

**Contents**

|   |    |
|---|----|
| Temporarily Holding On a System .....                         | 44 |
| Holding On a Channel .....                                    | 44 |
| Quickly Storing an ID During ID Search .....                  | 44 |
| Quick-Storing Channels or Talk Group ID's .....               | 44 |
| Quickly Recalling Channels .....                              | 45 |
| Monitoring Trunking Activity .....                            | 45 |
| <b>Other Settings</b> .....                                   | 46 |
| Displaying System Information .....                           | 46 |
| Viewing Memory Used .....                                     | 46 |
| Viewing the Firmware Version .....                            | 46 |
| Adjusting the Key Beep .....                                  | 46 |
| Locking/Unlocking the Keypad .....                            | 46 |
| Turning Power Save On or Off .....                            | 46 |
| Priority Scan .....   | 46 |
| Using the Backlight .....                                     | 47 |
| Initializing the Scanner's Memory .....                       | 47 |
| Using the PC Control and Cloning Options .....                | 48 |
| Connecting Your Scanner to a Personal Computer .....          | 48 |
| Cloning the Scanner .....                                     | 49 |
| <b>Using the Menu</b> .....                                   | 50 |
| <b>Programming Radio Systems</b> .....                        | 52 |
| Programming Conventional Systems .....                        | 53 |
| Entering/Editing Conventional Channel Groups .....            | 53 |
| Entering/Editing Conventional Channels .....                  | 54 |
| Programming Motorola Systems .....                            | 54 |
| Setting System Frequencies .....                              | 56 |
| Entering/Editing Motorola Channel Groups .....                | 56 |
| Entering/Editing Motorola Channels .....                      | 57 |
| Programming EDACS Systems .....                               | 58 |
| Setting System Frequencies .....                              | 59 |
| Entering/Editing EDACS Channel Groups .....                   | 59 |
| Entering/Editing EDACS Channels .....                         | 60 |
| Programming LTR Systems .....                                 | 60 |
| Setting System Frequencies .....                              | 61 |
| Entering/Editing LTR Channel Groups .....                     | 61 |
| Entering/Editing LTR Channels .....                           | 62 |
| <b>Programming/Editing Optional Settings</b> .....            | 63 |
| System-Level Settings .....                                   | 63 |
| Editing the System Name .....                                 | 63 |
| Editing the System Quick Key .....                            | 63 |
| Setting System Lockout .....                                  | 64 |
| Setting the System Hold Time .....                            | 64 |
| Setting the Channel Delay Time .....                          | 65 |
| Setting ID Scan/Search (Trunked Systems Only) .....           | 65 |
| Setting Data Skip (Conventional Systems Only) .....           | 66 |
| Editing the Fleet Map (Motorola Systems Only) .....           | 66 |
| Setting the Motorola Status Bit (Motorola Systems Only) ..... | 67 |
| Setting the End Code Operation (Motorola Systems Only).....   | 67 |
| Setting I-Call (Motorola and EDACS Systems Only) .....        | 68 |

|  |    |
|--|----|
| Setting Emergency Alert (Motorola & EDACS Systems Only) .....  | 68 |
| Setting the EDACS ID Format (EDACS Systems Only) .....         | 69 |
| Setting Control-Channel Only (Motorola Systems Only) .....     | 69 |
| Setting System Attenuation (Trunked Systems Only) .....        | 70 |
| Deleting Systems .....   | 70 |
| Copying Systems .....  | 71 |
| Group-Level Settings .....                                     | 71 |
| Entering/Editing the Group Name .....                          | 71 |
| Setting the Group Quick Key .....                              | 72 |
| Setting Group Lockout .....                                    | 72 |
| Deleting Groups .....  | 73 |
| Channel-Level Settings .....                                   | 73 |
| Editing the Channel Name .....                                 | 73 |
| Setting Channel Priority (Conventional Channels Only) .....    | 74 |
| Setting Channel Alert .....                                    | 74 |
| Setting CTCSS/DCS (Conventional Channels Only) .....           | 75 |
| Setting Channel Modulation (Conventional Channels Only) .....  | 76 |
| Setting Channel Attenuation (Conventional Channels Only) ..... | 76 |
| Setting the Frequency Step (Conventional Channels Only) .....  | 77 |
| Setting Channel Lockout .....                                  | 78 |
| Deleting Channels .....  | 78 |
| Copying/Pasting Channels .....                                 | 79 |
| <b>Searching and Storing</b> .....                             | 80 |
| Service Search .....   | 80 |
| Quick Search .....   | 81 |
| CTCSS/DCS Search .....   | 81 |
| Custom Search .....  | 81 |
| Editing a Custom Search Range .....                            | 82 |
| Auto Search and Store .....                                    | 83 |
| Selecting a System .....                                       | 84 |
| Storing a Conventional System .....                            | 84 |
| Storing a Trunked System .....                                 | 85 |
| <b>Using the Close Call Feature</b> .....                      | 86 |
| Setting Close Call Options .....                               | 87 |
| Close Call Hits .....  | 88 |
| <b>Search and Close Call Options</b> .....                     | 89 |
| Managing Locked-Out Frequencies .....                          | 89 |
| Unlocking All Frequencies .....                                | 89 |
| Reviewing Locked Out Frequencies .....                         | 89 |
| Searching for Subaudible Tones .....                           | 89 |
| Screening Out Paging Systems .....                             | 90 |
| Finding Repeater Output Frequencies .....                      | 90 |
| Setting the Maximum Auto Store Value .....                     | 91 |
| Setting the Modulation Type .....                              | 91 |
| Setting Attenuation .....                                      | 92 |
| Setting Data Skip .....  | 92 |
| Setting the Delay Time .....                                   | 93 |
| Setting the Search Frequency Step .....                        | 93 |

|  |     |
|--|-----|
| <b>Using Weather Alert (SAME)</b> .....                | 94  |
| Searching For a Weather Broadcast .....                | 94  |
| Turning Weather Alert On/Off .....                     | 94  |
| Programming a SAME Group .....                         | 95  |
| Setting WX Alert Priority .....                        | 96  |
| <b>Care and Maintenance</b> .....                      | 97  |
| General Use .....                                      | 97  |
| Location .....   | 97  |
| Cleaning .....   | 97  |
| Repairs .....  | 98  |
| Birdies .....  | 98  |
| <b>Troubleshooting</b> .....                           | 99  |
| <b>Specifications</b> .....                            | 102 |
| <b>Optional Accessories</b> .....                      | 104 |
| <b>Appendix</b> .....                                  | 105 |
| Preset Fleet Maps .....                                | 105 |
| User Defined Fleet Maps .....                          | 107 |
| Type I Programming Information .....                   | 107 |
| Size Code Restrictions .....                           | 108 |
| <b>Planning</b> .....                                  | 109 |
| Collecting Information .....                           | 109 |
| Filling Out The Conventional System Worksheet .....    | 110 |
| System Name and Quick Key .....                        | 110 |
| Group Name and Quick Key .....                         | 111 |
| Frequency-Alpha Tag-Priority-CTCSS/DCS .....           | 111 |
| Filling Out The Motorola Worksheet .....               | 111 |
| System Name and Quick Key .....                        | 111 |
| System Type .....                                      | 111 |
| System Frequencies .....                               | 112 |
| Fleet Map (Type I or Type I/Type II Hybrid Only) ..... | 112 |
| Band Plan (VHF or UHF Only) .....                      | 112 |
| Group Name and Quick Key .....                         | 112 |
| Talk Group ID-Alpha Tag-Alert .....                    | 113 |
| Filling Out the LTR and EDACS Worksheet .....          | 113 |
| System Name and Quick Key .....                        | 113 |
| System Frequencies and LCN .....                       | 113 |
| Group Name and Quick Key .....                         | 113 |
| Talk Group ID-Alpha Tag-Alert .....                    | 113 |
| Conventional System Worksheet .....                    | 114 |
| Motorola System Worksheet .....                        | 115 |
| LTR/EDACS System Worksheet .....                       | 117 |
| <b>Preprogrammed Systems</b> .....                     | 119 |
| <b>One-Year Limited Warranty</b> .....                 | 129 |

---

---

# The FCC Wants You to Know

---

---

This scanner has been tested and found to comply with the limits for a scanning receiver, pursuant to Part 15 of the *FCC Rules*. These limits are designed to provide reasonable protection against harmful interference in a residential installation. This scanner generates, uses, and can radiate radio frequency energy and, if not installed and used in accordance with the instructions, may cause harmful interference to radio communications.

However, there is no guarantee that interference will not occur in a particular installation. If this scanner does cause harmful interference to radio or television reception, which can be determined by turning the scanner on and off, you are encouraged to try to correct the interference by one or more of the following measures:

- Reorient or relocate the receiving antenna
- Increase the separation between the scanner and the receiver

This device complies with Part 15 of the *FCC Rules*. Operation is subject to the following two conditions:

1) This device may not cause harmful interference, and  
2) this device must accept any interference received, including interference that may cause undesired operation.

## Scanning Legally

Your scanner covers frequencies used by many different groups, including police and fire departments, ambulance services, government agencies, private companies, amateur radio services, military operations, pager services, and wireline (telephone and telegraph) service providers. It is legal to listen to almost every transmission your scanner can receive. However, there are some transmissions that you should never intentionally listen to. These include:

- Telephone conversations (cellular, cordless, or other private means of telephone signal transmission)
- Pager transmissions
- Any scrambled or encrypted transmissions

**The FCC Wants You to Know**



---

---

According to the Electronic Communications Privacy Act (ECPA), you are subject to fines and possible imprisonment for intentionally listening to, using, or divulging the contents of such a conversation unless you have the consent of a party to the conversation (unless such activity is otherwise illegal). This scanner has been designed to prevent the reception of cellular telephone transmissions and the decoding of scrambled transmissions. This is done to comply with the legal requirement that scanners be manufactured so they are not easy to modify to pick up these transmissions. Do not open your scanner's case to make any modifications that could allow it to pick up transmissions that are illegal to monitor. Modifying or tampering with your scanner's internal components or using it in a way other than as described in this manual could invalidate your warranty and void your FCC authorization to operate it.

In some areas, mobile use of this scanner is unlawful or requires a permit. Check the laws in your area. It is also illegal in many areas (and a bad idea everywhere) to interfere with the duties of public safety officials by traveling to the scene of an incident without authorization.

---

---

# Introduction

---

---

Your BC246T scanner is a state-of-the-art scanner radio with TrunkTracking™ and automatic scanning capabilities. You can store frequencies such as police, fire/emergency, marine, air, amateur, and other communications into the scanner. You can carry it with you wherever you go, use it at home as a base unit, or install it in your vehicle as a mobile unit.

You can use the scanner's scroll control to quickly select channels and frequencies, and you can automatically program channels in a system using the AutoStore feature.

Use your scanner to monitor:

- Trunked public safety systems
- Police and fire departments (including rescue and paramedics)
- NOAA weather transmissions
- Business/Industrial radio
- Utilities
- Marine and amateur (ham radio) bands
- Air band
- Railroad

This table lists the frequency ranges, default frequency step, default mode (AM or Narrowband FM), and type of transmissions you can hear for each range.

| <b>Frequency Range (MHz)</b> | <b>Step (kHz)</b> | <b>Mode</b> | <b>Transmission</b>          |
|------------------------------|-------------------|-------------|------------------------------|
| 25.0-26.960                  | 5                 | AM          | Petroleum/<br>Broadcast Band |
| 26.965-<br>27.405            | 5                 | AM          | Citizens Band Class D        |
| 27.410-<br>27.995            | 5                 | AM          | Business Band                |
| 28.0-29.800                  | 20                | NFM         | 10 Meter<br>Amateur Band     |

|                         |      |     |                            |
|-------------------------|------|-----|----------------------------|
| 29.7-49.990             | 10   | NFM | VHF Low Band               |
| 50.0-54.0               | 20   | NFM | 6 Meter<br>Amateur Band    |
| 108.0-<br>136.9750      | 25   | AM  | Aircraft Band              |
| 137.0-<br>143.9875      | 12.5 | NFM | Military Band              |
| 144.0-<br>147.995       | 5    | NFM | 2 Meter<br>Amateur Band    |
| 148.0-<br>150.7875      | 12.5 | NFM | Miscellaneous              |
| 150.800-<br>161.995     | 5    | NFM | VHF High Band              |
| 162.0-174.0             | 12.5 | NFM | Federal<br>Government      |
| 216.0-224.98            | 20   | NFM | 1.25 Meter Amateur<br>Band |
| 400.0-<br>405.9875      | 12.5 | NFM | Miscellaneous              |
| 406.0-<br>419.9875      | 12.5 | NFM | Federal Land Mobile        |
| 420.0-<br>449.9875      | 12.5 | NFM | 70 cm<br>Amateur Band      |
| 450.0-<br>469.9875      | 12.5 | NFM | UHF<br>Standard Band       |
| 470.0-512.0             | 12.5 | NFM | UHF TV Band                |
| 806.0-<br>823.9875      | 12.5 | NFM | Public Service Band        |
| 849.0125-<br>868.9875   | 12.5 | NFM | Public Service Band        |
| 894.0125-<br>956.0000   | 12.5 | NFM | Public Service Band        |
| 1240.0000-<br>1300.0000 | 25   | NFM | 25 cm<br>Amateur Band      |

---

---

# Feature Highlights

---

---

## General

**Close Call™ RF Capture Technology** - you can set the scanner so it detects and provides information about nearby radio transmissions. See “Using the Close Call Feature” on Page 86 for more information.

**Dynamically Allocated Channel Memory** - your scanner’s memory is organized so that it more closely matches how radio systems actually work, making it easier to program and use your scanner and determine how much memory you have used and how much you have left.

**Preprogrammed Systems** - your scanner is preprogrammed with over 400 channels covering police, fire, and ambulance operations in the 25 most populated counties in the US. A complete list of the scanner’s preprogrammed systems is in “Preprogrammed Systems” on Page 119.

**Quick Keys** – You can set the scanner so you can select systems and groups by pressing a single key. This makes it easy to listen to or quickly lock out those systems or groups you don’t want to scan.

**Pager Screen** – You can set the scanner so it ignores hits generated by common pager frequencies while using the Close Call or search features.

**Ten Service Searches** - frequencies are preset in separate public safety, news, amateur radio, marine, railroad, air, CB radio, FRS/GMRS, racing, and special searches, to make it easy to find specific transmissions.

**Lockout** – You can lock out any system, group, frequency, or channel while scanning. If you lock out a system or group, any channels belonging to that system or group are also locked out.

You can lock out up to 200 frequencies. The scanner skips locked-out frequencies while using the Close Call feature or while searching.

**CTCSS and DCS Squelch Modes** – prevent interference from stations not using the mode you select.

## Feature Highlights

---

---

**Dropout Delay** – You can set whether the scanner pauses at the end of a transmission to wait for a reply. You can set the delay time for each system you scan, and while searching and using the Close Call feature.

**Attenuator** – You can set the scanner's attenuator to reduce the input strength of strong signals by about 18 dB received by the scanner.

**Repeater Reverse** – You can set the scanner so it switches to the input frequency on a conventional repeater system.

**Channel Alert** – You can set the scanner so it alerts you when there is activity on any channel you specify.

**Memory Check** – Lets you see at a glance how much total memory is left.

**Frequency Step** – Lets you select a frequency step (5, 6.25, 7.5, 10, 12.5, 15, 20, 25, 50 or 100 kHz) for manual mode and chain search mode. The scanner's auto step feature lets you set the scanner so it automatically chooses the correct step.

**Quick Recall** – Lets you quickly select a specific channel by choosing the system, group, and channel.

**Scan/Search Delay** – You can set the scanner so it remains on a frequency up to 5 seconds after the last transmission to wait for a possible reply.

**Text Tagging** – You can name each system, group, channel, talk group ID, custom search range, and SAME group, using up to 16 characters per name.

**Unique Data Skip** – Allows your scanner to skip unwanted data transmissions and reduces birdies.

**Duplicate Frequency Alert** – Alerts you if you try to enter a duplicate name or frequency already stored in the scanner.

**Memory Backup** – If power is lost or disconnected, the scanner retains the frequencies you programmed in its memory.

## Feature Highlights

---

---

**21 Bands** – Includes 21 bands, with Aircraft and 800 MHz.

**Note:** The scanner's frequency coverage is not continuous and does not include the cellular telephone band.

## Trunk Tracking

**Trunk Tracker™ Operation** – Follows conversations on analog Motorola, EDACS, EDACS SCAT, and LTR trunked radio systems. The scanner can scan both conventional and trunked systems at the same time.

**Control Channel Only Scanning** – If the scanner is set to scan Motorola trunking frequencies, you can set it so it scans using only control channel data. You do not have to program voice channel frequencies into memory in this mode.

## Weather

**Weather Search** – Lets your scanner receive your local NOAA weather transmission.

**SAME Weather Alert** – Lets your scanner alert you when a SAME weather alert is transmitted on a NOAA weather channel. The scanner also displays the transmitted alert type. This helps you quickly find out about severe weather in your area and lets you avoid false alarms.

## Search

**Service Search** – Lets you quickly select and search the scanner's preprogrammed frequencies.

**Custom Search** – Lets you program up to 10 custom search ranges. You can search any of these ranges simultaneously.

**CTCSS/DCS Search** – Lets the scanner search for CTCSS or DCS tones. You can identify up to 50 CTCSS tones and 104 DCS tones.

**Quick Search** – Lets you search from the currently-tuned frequency if you are searching a conventional system.

## Feature Highlights

---

---

## Auto Store

**Frequency AutoStore** – Automatically stores all active frequencies within a system you select.

**Talk Group ID AutoStore** – Automatically stores all new talk group ID's into a system you select.

## Priority

**Priority Scan** – Priority channels let you keep track of activity on your most important channel(s) while monitoring other channels for transmissions.

**Priority Plus** – You can set the scanner so it scans only the priority channels

## Backlight and Power

**LCD Back Light** – Makes the display easy to see in dim light. You can adjust the back light so it turns on when you press a key, when squelch breaks during a transmission, or manually.

**Low Battery Alert** – The scanner alerts you if the batteries need to be recharged or replaced.

**Battery Save** – You can set the scanner so it reduces the amount of power it needs if there are no transmissions.

## Key Controls

**Key Lock** – You can deactivate the scanner's keys to help prevent accidentally changing the scanner's programming.

## PC Control and Cloning

**PC Control** – You can transfer programming data to and from your scanner and your personal computer, and control the scanner using a computer. This helps you find frequencies listed on the Internet and load them into the scanner.

## Feature Highlights

---

---

**Clone Mode** – You can clone all programmed data, including the contents of the scanner’s memory, menu settings, and other parameters from one BC246T scanner to another BC246T scanner.

## About This Manual

The screen displays used in this manual are representations of what might appear when you use your scanner. Since what you see depends on the frequencies and user ID’s for your area and the settings you select, you might notice some differences between what is in this manual and what appears on your scanner.

## How the Scanner’s Controls Are Represented in This Manual

To help navigate the scanner’s menus, the steps shown in this manual show the displays you see and the keys you press or control you operate to get a desired result.

This example shows you how to use the scanner’s menu to edit an existing system name. It shows you the key to press (**Menu**) to select a menu option and the option you see (*PROGRAM SYSTEM*) when you press **Menu**. It also instructs you to turn the scroll control (shown as **U**) to view a series of choices then select one choice (*EDIT NAME*).

**Menu** → *PROGRAM SYSTEM* → **E** **U** →

Select the system → **E** **U**

**U** → *EDIT NAME* → **E** → System Name

To get the most from this manual, review the contents to become familiar with the basic functions available.

If you are new to scanning or trunk tracking, be sure to read “Understanding Scanning” on Page 18 for a quick background on the technology. The first thing you’ll need to do is install batteries in the scanner. Then you need to connect the included antenna to the scanner.

See “Setting Up Your Scanner” on Page 30 if you need any help doing this.

## Feature Highlights



---

---

## ***Entering Text***

To enter a letter, turn the scroll control until the character you want appears, To enter a number, press a number key. To enter a decimal point, press •.

To move the cursor to the left, hold **Func** then press **</4** or rotate the scroll control to the left. To move the cursor to the right, hold **Func** then press **6/>** or rotate the scroll control to the right.

To clear a character, press **No** twice. To clear all characters, press **No** 3 times.

To accept an entry, press **E** or press down on the scroll control.

---

---

# Understanding Scanning

---

---

This section provides you with background on how scanning works. You don't really need to know all of this to use your scanner, but some background knowledge will help you get the most from your BC246T.

## Understanding the Scanner's Memory

Your scanner's memory is organized in an architecture called *Dynamic Allocated Channel* memory. This type of memory is organized differently and more efficiently than the bank/channel architecture used by traditional scanners. Dynamic Allocated design matches how radio systems actually work much more closely, making it easier to program and use your scanner and determine how much memory you have used and how much you have left.

Instead of being organized into separate banks and channels, your scanner's memory is contained in a *pool*. You simply use as much memory as you need in the pool to store as many frequencies, talk group ID's, and alpha tags as you need. No memory space is wasted, and you can tell at a glance how much memory you have used and how much remains.

With a traditional scanner, when you program it to track a trunked system, you must first program the frequencies. Since you can only program one trunking system per bank in a traditional scanner, if there were (for example) 30 frequencies, the remaining 70 or so channels in the bank are not used and therefore wasted. Also, since some trunked systems might have hundreds of talk groups, you would have had to enter those types of systems into multiple banks in order to monitor and track all the ID's.

## What is Scanning?

Unlike standard AM or FM radio stations, most two-way communications do not transmit continuously. Your BC246T scans programmed channels until it finds an active frequency, then stops on that frequency and remains on that channel as long as the transmission continues. When the transmission ends, the scanning

## Understanding Scanning

---

---

cycle resumes until the scanner receives another transmission.

## **What is Searching?**

The BC246T can search each of its 21 bands and up to 10 bands together to find active frequencies. This is different from scanning because you are searching for frequencies that have not been programmed into the scanner. When you select frequency bands to search, the scanner searches for any active frequency within the lower and upper limits you specify. When the scanner finds an active frequency, it stops on that frequency as long as the transmission lasts. If you think the frequency is interesting, you can program it into the scanner's memory. If not, you can continue to search.

## **What is CTCSS/DCS?**

Your scanner can monitor systems using a Continuous Tone Coded Squelch System (CTCSS) and Digital Coded Squelch (DCS) system, which allow squelch to open only when the tone you have programmed with a specific frequency is received along with a transmission.

CTCSS and DCS are subaudible tone signaling systems sometimes referred to as PL or DPL (Motorola's trademarked terms for Private Line and Digital Private Line respectively). CTCSS and DCS are used only for FM signals and are usually associated with both amateur and commercial two-way frequencies. These systems make use of a special subaudible tone that accompanies a transmitted signal.

CTCSS and DCS are used for many purposes. In many cases, CTCSS and DCS are used to restrict access to a commercial repeater, so that only those units, which transmit the correct tone along with their signal can "talk" to the repeater.

CTCSS and DCS are also used in areas that receive interference where there are several stations with output frequencies close to each other. When this occurs, you might hear multiple communications on the same

## **Understanding Scanning**

frequency. The stations might even interfere with each other to the point where it is impossible to clearly receive any of the stations. A scanner equipped with CTCSS and DCS (like your scanner) can code each received frequency with a specific CTCSS or DCS frequency. Then, when you receive multiple signals, you only hear the transmission with the CTCSS or DCS tone you programmed. If you do not receive the correct tone with a signal, the scanner's squelch remains closed and you hear nothing.

You can search for the following CTCSS frequencies and DCS codes.

### CTCSS Frequencies (Hz)

|       |       |       |       |       |       |
|-------|-------|-------|-------|-------|-------|
| 67.0  | 69.3  | 71.9  | 74.4  | 77.0  | 79.7  |
| 82.5  | 85.4  | 88.5  | 91.5  | 94.8  | 97.4  |
| 100.0 | 103.5 | 107.2 | 110.9 | 114.8 | 118.8 |
| 123.0 | 127.3 | 131.8 | 136.5 | 141.3 | 146.2 |
| 151.4 | 156.7 | 159.8 | 162.2 | 165.5 | 167.9 |
| 171.3 | 173.8 | 177.3 | 179.9 | 183.5 | 186.2 |
| 189.9 | 192.8 | 196.6 | 199.5 | 203.5 | 206.5 |
| 210.7 | 218.1 | 225.7 | 229.1 | 233.6 | 241.8 |
|       |       | 250.3 | 254.1 |       |       |

### DCS Codes (Octal)

|     |     |     |     |     |     |     |     |
|-----|-----|-----|-----|-----|-----|-----|-----|
| 023 | 025 | 026 | 031 | 032 | 036 | 043 | 047 |
| 051 | 053 | 054 | 065 | 071 | 072 | 073 | 074 |
| 114 | 115 | 116 | 122 | 125 | 131 | 132 | 134 |
| 143 | 145 | 152 | 155 | 156 | 162 | 165 | 172 |
| 174 | 205 | 212 | 223 | 225 | 226 | 243 | 244 |
| 245 | 246 | 251 | 252 | 255 | 261 | 263 | 265 |
| 266 | 271 | 274 | 306 | 311 | 315 | 325 | 331 |
| 332 | 343 | 346 | 351 | 356 | 364 | 365 | 371 |
| 411 | 412 | 413 | 423 | 431 | 432 | 445 | 446 |

---

---

|     |     |     |     |     |     |     |     |
|-----|-----|-----|-----|-----|-----|-----|-----|
| 452 | 454 | 455 | 462 | 464 | 465 | 466 | 503 |
| 506 | 516 | 523 | 526 | 532 | 546 | 565 | 606 |
| 612 | 624 | 627 | 631 | 632 | 654 | 662 | 664 |
| 703 | 712 | 723 | 731 | 732 | 734 | 743 | 754 |

## Conventional Scanning

Conventional scanning is a relatively simple concept. Each group of users in a conventional system is assigned a single frequency (for simplex systems) or two frequencies (for repeater systems). Any time one of them transmits, their transmission always goes out on the same frequency. Up until the late 1980s, this was the primary way that radio systems operated.

Even today, there are many 2-way radio users who operate using a conventional system:

- Aircraft
- Amateur radio
- FRS/GMRS users
- Broadcast AM/FM/TV stations
- Many business radio users

When you want to store a conventional system, all you need to know is the frequencies they operate on. When you are scanning a conventional system, the scanner stops very briefly on each channel to see if there is activity. If there isn't, the scanner quickly moves to the next channel. If there is, then the scanner pauses on the transmission until it is over.

### ***Simplex Operation***

Simplex systems use a single frequency for both transmit and receive. Most radios using this type of operation are limited to line-of-sight operation. This type of radio is frequently used at construction job sites, and with inexpensive consumer radios such as GMRS/FRS radios. The range is typically 1-8 miles, depending upon the terrain and many other factors.

## Understanding Scanning

---

---

## **Repeater Operation**

Repeater systems use two frequencies: one transmits from the radio to a central repeater; the other transmits from the repeater to other radios in the system. With a repeater-based system, the repeater is located on top of a tall building or on a radio tower that provides great visibility to the area of operation. When a user transmits (on an input frequency), the signal is picked up by the repeater and retransmitted (on an output frequency). The user's radios always listen for activity on the output frequency and transmit on the input frequency. Since the repeater is located very high, there is a very large line of sight.

Typical repeater systems provide coverage out to about a 25-mile radius from the repeater location.

## **What is Trunk Tracking?**

Your BC246T is designed to track the following types of trunking systems.

- Motorola Type I, Type II, Type III hybrid, SMARTNET, and PRIVACYPLUS analog trunking systems, which are extensively used in 800 MHz communication systems.
- LTR trunking systems
- EDACS SCAT trunking systems
- EDACS trunking systems

When tracking these types of systems, you might want to remember these important points:

- Your scanner can track more than one trunking system at a time and scan conventional and trunked systems at the same time.
- The frequencies for many of the 800 MHz public safety systems are listed in the *National Public Safety Trunked System Frequency Guide* included with your BC246T scanner.

Conventional scanning is a simple concept. You enter a frequency used by someone you want to monitor into

## **Understanding Scanning**

---

---

your scanner's memory. For example, the police in your area might transmit on 460.500 MHz, the fire department on 154.445 MHz, the highway department on 37.900 MHz, etc. So when your scanner stops on a frequency, you usually know who it is, and more importantly, you can stop on a channel and listen to an entire conversation. This type of scanning is easy and fun.

However, as the demand for public communications has increased, many public radio users do not have enough frequencies to meet their needs, creating a serious problem. Trunking radio systems help solve this problem.

## **Trunked Scanning**

While conventional scanning worked great while there were only a few groups wanting to use the frequencies, with the advent of smaller, lower-cost radios more and more agencies and businesses wanted to take advantage of the utility of 2-way radio. As a result, the bands that were used most became full, so new users were not able to take advantage of the technology as quickly as they wanted.

Trunking solved this frequency shortage by allowing multiple groups to use the same set of frequencies in a very efficient way. While each type of trunking system operates a little differently (see the next few sections), they all work on the same basic premise: even in a system with a lot of users, only a few users are ever transmitting at any one time.

Instead of being assigned a frequency, as with conventional systems, each group is assigned a talk group ID. A central computer controls the frequency each group operates on...and this frequency selection is made each time a user transmits. So, while on a conventional system queries, replies, and follow-ups are all on a single frequency, they could each be on completely different frequencies on a trunked system. This semi-random frequency assignment made monitoring such a system impossible prior to Uniden's invention of the Trunktracking scanner.

## **Understanding Scanning**

---

---

Not only does your BC246T scan channels like a conventional scanner, it actually follows the users of a trunked radio system. Once you know a talk group's ID, you won't miss any of the action.

If you are a new scanner enthusiast, you might want to read the first part of this manual and use your scanner in conventional mode before you begin trunk tracking. Understanding scanning fundamentals and terminology will make trunk tracking much easier. If you are already an experienced scanner operator, you might want to go to "Programming Motorola Systems" on Page 54, "Programming EDACS Systems" on Page 58, or "Programming LTR Systems" on Page 60 now.

## **Types of Trunking Systems**

Trunking systems divide a few frequencies among many different users, but the way that each system does this is slightly different. This section describes some of the technical data behind Motorola, EDACS, and LTR trunked radio systems.

### ***Motorola Trunking***

While there are different types of Motorola trunking systems, they all use the same basic trunking method. The system consists of one control channel (or as many as 4 per system), plus one or more voice channels (typically 10, 20, or 28 total channels). When a user presses Push To Talk (PTT) to transmit, their radio first sends their talk group information to the control channel. The computer then assigns that talk group to a specific voice channel and transmits that data over the control channel. All radios in that talk group switch over to the assigned voice channel and the user can begin speaking. This all typically takes place in about a second...the person transmitting hears a beep from their radio when the channel is assigned and then it is OK to start talking.

The systems in use are:

Motorola Type I – the radios send the radio ID, the fleet and subfleet talk group ID to the control channel each

## **Understanding Scanning**



---

---

time they transmit. To program a Type I system, you need to know the system's *fleet map*. The most common fleet maps are included in "Preset Fleet Maps" on Page 105. You can also find fleet map resources on the web.

Motorola Type II – the radios only send the radio ID and radio channel code to the control channel. The central computer keeps a database of radio ID's and which talk group is assigned to which channel code for each radio, so with this system the user's radio sends only about  $\frac{1}{3}$  the data as a Type I system with each transmission. Type II systems do not use Fleet-subfleet talk groups; instead they use a 5-digit ID for each talk group.

Type III Hybrid — these systems support a mix of both Type I and Type II users. Like Type I systems, you must know the system's fleet map to ensure proper tracking.

## ***EDACS Trunking***

EDACS trunking works in much the same way as Motorola trunking with a couple of major differences. In an EDACS system, each frequency used by the system is assigned a Logical Channel Number (LCN) so that less data needs to be transmitted by the control channel. Also, talk groups are assigned in an Agency-Fleet-Subfleet (AFS) hierarchy. Also, there is one variation of EDACS called SCAT that your BC246T can monitor.

Logical Channel Numbers – each frequency used by the system is assigned an LCN. This information is programmed into each user radio. When a user presses PTT, their radio sends their AFS information to the control channel. The computer then assigns that talk group to a channel and sends the LCN so that all other radios in that talk group will switch to the correct channel. To program an EDACS system in your scanner, you will need to know both the frequencies used by the system and the LCN for each frequency.

Agency-Fleet-Subfleet – talk group ID's for EDACS systems are assigned in a way that makes it easy to see

## **Understanding Scanning**

---

---

at a glance the affiliation of the user. Each radio is assigned a 2-digit agency identifier from 00 – 15. For example, 01 might be used by the police, 02 by ambulance service, 03 by the fire department, and so on. Each agency is then subdivided up to 16 times to provide fleet identification, and then 8 more times to identify subfleets.

For example, the complete AFS for the Police Department West District's dispatch channel might be 01-062. 01 identifies the agency as the police department, 06 identifies the fleet as the West district, and 2 identifies the subfleet as the dispatch channel. While these assignments are somewhat arbitrary and vary from system to system, there are many resources on the web for finding the assignments for most systems. Because of the logical hierarchy of the AFS system, your BC246T lets you assign wildcard ID's that let you, for example, use only one ID memory to identify all units in either an agency or a fleet.

EDACS SCAT – EDACS SCAT (Single Channel Autonomous Trunking) systems operate on a single channel and alternate control data with analog voice traffic. While your BC246T cannot track ID's in this system, it can eliminate the control data so that all you hear is the voice transmissions when you monitor this type of system.

## ***LTR Trunking***

LTR (Logic Trunked Radio) systems are trunking systems used primarily by business or private communications service providers, such as taxicabs, delivery trucks, and repair services. These systems encode all control information as digital subaudible data that accompanies each transmission, so there is no separate control channel. Users on an LTR system are assigned to specific talk groups, which are identified by the radio as six digit numbers.

---

---

These numbers are in the form AHHUUU, where:

A = Area code (0 or 1)

H = Home repeater (01 through 20)

U = User ID (000 through 254)

When the scanner receives a transmission on a channel set to the LTR mode, it first decodes the LTR data included with the transmission. In the ID search mode, the scanner stops on the transmission and displays the talk group ID on the display. In the ID scan mode, the scanner only stops on the transmission if the LTR data matches a talk group ID that you have stored in the talk group ID list and have not locked out. LTR systems are frequently programmed so that each radio has a unique user ID.

## **Where To Get More Information**

By itself, this manual really only provides part of what you need to know to have fun scanning – how to program and use the scanner. The two included conventional and trunking frequency guides will give you a good head start on the other part of what you need to know – what frequencies have interesting content.

### ***Information On The Internet***

The Internet is a great source for current frequencies and information about scanning. Many web sites have lists of frequencies for your area. You can use a search engine to find and use them.

Make a list of the agencies you want to listen to, then look up the frequencies and systems used by those agencies. Here are a few useful sites:

- <http://www.scannermaster.com> \* - frequency resources and home of Police Call.

You can also call them at 1 800 SCANNER (hours are from 10:00 a.m. to 5:00 p.m. Eastern Time Monday through Friday).

- 
- 
- <http://www.radioreference.com> \* - the Internet's premier source for user-supported radio system information.
  - <http://www.bearcat1.com> - frequency information from National Communications.
  - <http://svartifoss2.fcc.gov/reports/index.cfm> \* - conventional frequency information on file with the US Government
  - <http://groups.yahoo.com/group/BC246T> \* - a group for people interested in discussing the BC246T.

\* - *These web sites are not affiliated with Uniden Corporation.*

To purchase another copy of the conventional or trunking frequency guide, contact your local dealer or:

Uniden Parts Department  
(800) 554-3988  
(Hours are from 8:00 a.m. to 5:00 p.m. Central Time  
Monday through Friday.)

For more information about Uniden and our other products, visit <http://www.uniden.com>.

# Included With Your Scanner

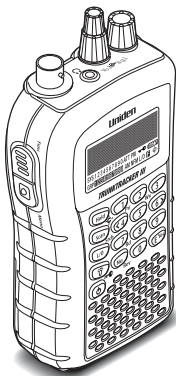

Scanner

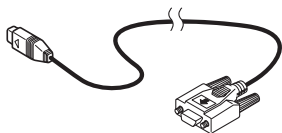

Connection  
Cable



Wrist Strap

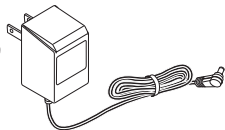

AC Adapter



Batteries

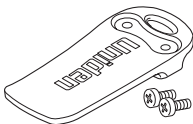

Belt Clip

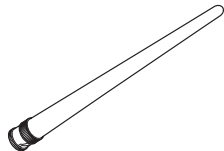

Antenna



Frequency Guide



Owners  
Manual

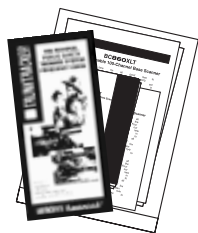

National Public Safety  
Trunked System  
Frequency Guide

If any of these items are missing or damaged, immediately contact your place of purchase or Uniden Customer Service at: (800) 297-1023, 8:00 a.m. to 5:00 p.m., Central, Monday through Friday.

**Included With Your Scanner**

---

---

# Setting Up Your Scanner

---

---

These guidelines will help you install and set up your new scanner:

- If your scanner receives interference or electrical noise, move the scanner or its antenna away from the source.
- To improve the scanner's reception, use an optional external antenna designed for multi-band coverage. (You can purchase this type of antenna at a local electronics store). If the optional antenna has no cable, use 50-70  $\Omega$  coaxial cable for lead-in. A mating plug might be necessary for the optional antennas.
- Use an optional mono earphone or mono headset with proper impedance (32  $\Omega$ ) for private listening. Read the precautions on the inside front cover of this Owners Manual.
- Do not use the scanner in high-moisture environments such as the kitchen or bathroom.
- Avoid placing the scanner in direct sunlight or near heating elements or vents.

## Using Internal Batteries

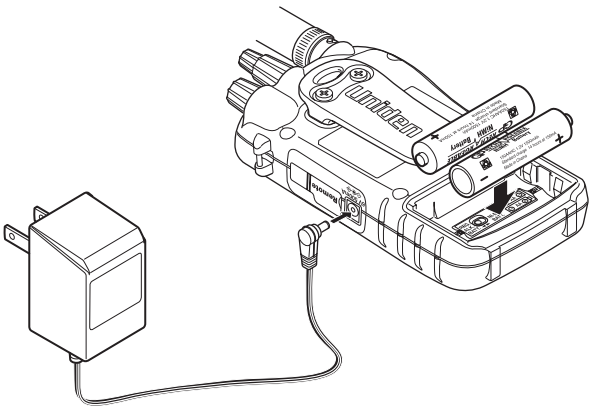

You can power your scanner using two alkaline, or rechargeable AA batteries.

Before installing batteries, set the switch in the battery compartment to match the type of batteries you will use. Select **REG. ALK. BATT.** for non-rechargeable battery types and **NI-MH. BATT.** for rechargeable battery types. See also “Using Rechargeable Batteries” on Page 32 when you use rechargeable batteries.

1. Remove the battery cover and set the battery switch.

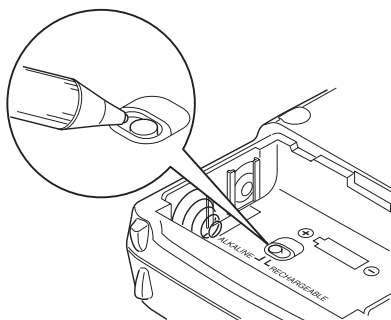

2. Install 2 AA batteries, matching the polarity symbols (+ -).

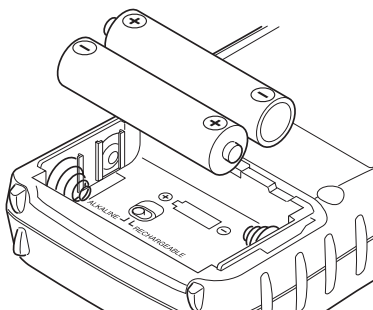

## **WARNING!**

Set **REG. ALK. BATT./NI-MH. BATT.** to **NI-MH. BATT.** for use only with rechargeable batteries.

Never attempt to recharge non-rechargeable batteries. Non-rechargeable batteries can get hot and can even burst if you try to recharge them.

---

---

3. Replace the cover.

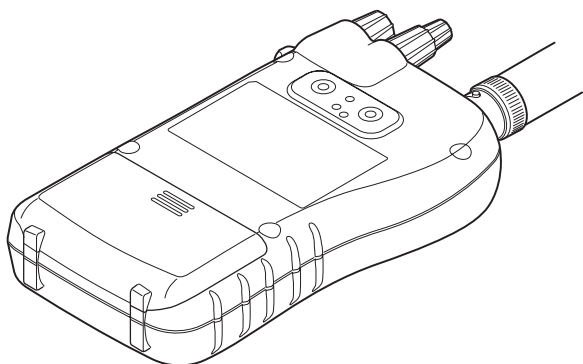

When **BATT** flashes and the scanner beeps every 15 seconds, replace both batteries.

## Using Rechargeable Batteries

You can also use two rechargeable batteries to power your scanner. Before you use rechargeable batteries, you must charge them.

The scanner has a built-in circuit that lets you recharge batteries while they are in the scanner. To charge the batteries, set **REG. ALK. BATT./NI-MH. BATT.** inside the battery compartment to **NI-MH. BATT.**, install the batteries in the scanner, and connect the supplied AC adapter to the scanner's DC 6V jack (see "Using AC Power" on Page 33).

### **WARNING!**

Do not connect the AC adapter to the scanner if non-rechargeable batteries (such as alkaline batteries) are installed in the scanner and

**REG. ALK. BATT./NI-MH. BATT.** is set to **NI-MH. BATT.**, or if you are unsure of the switch's position. Non-rechargeable batteries can get hot and can even burst if you try to recharge them.



---

---

Before you use rechargeable batteries for the first time, charge them for 14 hours to bring them to a full charge.

Discharged batteries take about 14 hours to fully recharge.

## Using AC Power

You can power the scanner using the supplied 6V, 500 mA AC adapter.

To use the scanner on AC power, plug the AC adapter into a standard AC outlet.

If rechargeable batteries are installed and **REG. ALK. BATT./NI-MH. BATT.** is set to **NI-MH. BATT.**, the adapter powers the scanner and recharges the installed batteries at the same time.

## Connecting the Antenna

To attach the supplied flexible antenna to the connector on the top of your scanner, align the slots around the antenna's connector with the tabs on the scanner's BNC connector. Then slide the antenna's connector down over the scanner's connector and rotate the antenna connector's outer ring clockwise until it locks into place.

### *Connecting an Optional Antenna*

The scanner's BNC connector makes it easy to connect a variety of optional antennas, including an external mobile antenna or outdoor base station antenna.

Note: Always use 50-ohm, RG-58, or RG-8, coaxial cable to connect an outdoor antenna. If the antenna is over 50 feet from the scanner, use RG-8 low-loss dielectric coaxial cable. You can get a BNC adapter at your local electronics store.

---

---

## Connecting an Earphone/Headphone

For private listening, you can plug a  $\frac{1}{8}$ -inch (3.5 mm) mini-plug earphone or headphones (not supplied) into the headphone jack on top of your scanner.

This automatically disconnects the internal speaker. See “Earphone Warning” at the front of the manual for important information about using an earphone/headphone.

## Connecting an Extension Speaker

In a noisy area, an optional amplified extension speaker, positioned in the right place, might provide more comfortable listening. Plug the speaker cable's  $\frac{1}{8}$ -inch (3.5-mm) mini-plug into your scanner's jack.

### **WARNING!**

If you connect an external speaker to the scanner's headphone jack, never connect the audio output line to a power supply and ground. This might damage the scanner.

## Attaching the Belt Clip

To make your scanner easier to carry when you are on the go, use the supplied belt clip. Use a Phillips screwdriver and the supplied screws to attach the clip to the scanner.

---

---

## Attaching the Wrist Strap

To keep your scanner safely close at hand, use the supplied wrist strap. Push the small loop on one end of the wrist strap through the lug on the right side of the scanner, then thread the other end of the wrist strap back through the small loop to secure it.

## Installing the Demo Software

You can operate your scanner using a personal computer and the free demo software available at <http://www.uniden.com>.

Download the software, then double-click on the install package to begin installation. The BC246T SS Install program installs the software. You must install the software to use the scanner with your computer.

After you install the BC246T SS Install program, start it by double clicking on the desktop icon or by selecting it in the Start Programs list.

You can upgrade the included software to a full version by purchasing a registration key at <http://www.uniden.com>.

## A Look At The Keypad

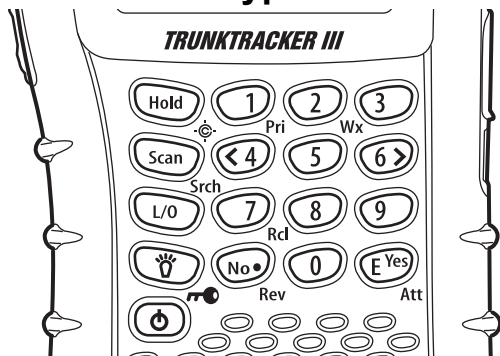





Your scanner's keys have various functions labeled on the key tops and below the keys.

To select the function labeled on a key, simply press the key. To select the function labeled below a key, hold down **Func** on the left side of the scanner then press the key.

**F** appears on the display.

If your scanner's keys seem confusing at first, the following information should help you understand each key's function.

| Key Name         | Description  |
|------------------|--|
| <b>Hold/</b>     | <p><b>Hold</b> – Holds the scan or the frequency search.</p> <p><b>Func</b> +  – Quickly turns the Close Call feature on or off (see “Setting Close Call Options” on Page 87).</p> |
| <b>Scan/Srch</b> | <p><b>Scan</b> – Scans the stored channels.</p> <p><b>Func</b> + <b>Srch</b> – Starts quick search or quickly accesses the search menu.</p>  |

| Key Name  | Description   |
|---|---|
| L/O   | <p>L/O – Lets you lock out a selected channel or skip a specified frequency.</p> <p><b>[Func]</b> + L/O – Press quickly to lock and unlock a selected system in Scan or Scan Hold mode and review search lockout frequencies in Search or Search Hold mode. Press and hold for more than 2 seconds to lock all groups and channels in a system.</p> |
|  /  | <p> – Turns the display backlight on or off.</p> <p><b>[Func]</b> +  – Locks and unlocks the keypad.</p>  |
|   | <p>Press and hold for more than 2 seconds to turn the scanner on or off. Press quickly to cancel a prompt.</p>  |
| 1-9, 0  | <p>1-9, 0 – Enters a frequency, enters quick key numbers, and selects a custom search range in Custom Search mode.</p> <p>Selects systems by quick key in scan mode.</p> <p><b>[Func]</b> + 1-9, 0 – Selects groups by quick key in scan mode.</p>  |
| 1/Pri   | <p>1 – Enters a 1.</p> <p><b>[Func]</b> + Pri – Selects the priority mode in scan hold mode.</p>  |

| Key Name         | Description  |
|------------------|--|
| <b>2/Wx</b>      | <p><b>2</b> – Enters a 2.</p> <p><b>[Func] + WX</b> – Selects the weather function in the menu in the Hold mode.</p>   |
| <b>&lt;/4</b>    | <p><b>4</b> – Enters a 4.</p> <p><b>[Func] + &lt;</b> – Moves the active character to the left while editing data.</p>   |
| <b>6/&gt;</b>    | <p><b>6</b> – Enters a 6.</p> <p><b>[Func] + &gt;</b> – Moves the active character to the right while editing data.</p>  |
| <b>7/Rcl</b>     | <p><b>7</b> – Enters a 7.</p> <p><b>[Func] + Rcl</b> – Displays a series of prompts to quickly select a specific channel in the scan hold mode.</p>  |
| <b>No/•/Rev</b>  | <ul style="list-style-type: none"> <li>• – Enters a decimal point or dash in a frequency or talk group ID, enters an “i” for I-Call input.</li> </ul> <p>At a prompt, answers “No.”</p> <p><b>[Func] + Rev</b> – Monitors the currently-tuned frequency’s reverse frequency.</p>   |
| <b>E/Yes/Att</b> | <p><b>E</b> – Press to select input and menu items, to quickly edit a channel in Scan Hold Mode, and store a frequency into memory in Scan Hold mode.</p> <p>At a prompt, answers “Yes.”</p> <p><b>[Func] + Att</b> – Turns the scanner’s attenuator on or off for the current channel (for conventional systems) or system (for trunked systems).</p> |

## Setting Up Your Scanner

---

---

## A Look At The Display

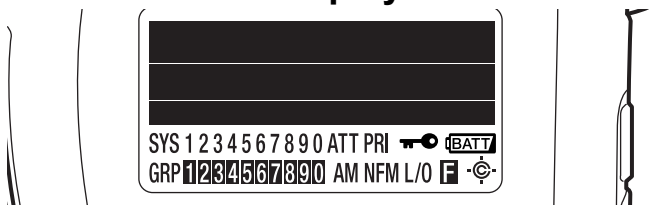



The display has indicators that show the scanner's current operating status. The display information helps you understand how your scanner operates. The dark area shown above the icons in this illustration is the text display area. Information about the currently tuned frequency appears here.

**SYS** - shows the currently activated system, appears with numbers (0-9). The currently active system indicator flashes.

**ATT** - appears when the attenuation feature is turned on (see "Setting System Attenuation (Trunked Systems Only)" on Page 70).

**PRI** - appears when the priority feature is turned on (see "Priority Scan" on Page 46).



 - appears when you lock the keypad (see "Locking/Unlocking the Keypad" on Page 46).

 - alerts you when the battery power gets low.

**GRP** - shows the currently activated group, appears with numbers (**0-9**). The currently active group indicator flashes.

**AM/FM/NFM** - appears to show the type of transmission.

**L/O** - appears when you manually select a channel you locked out or a skip frequency.

 - appears when you hold down  to select a function.

 - appears when the scanner is set to a Close Call feature mode (see "Using the Close Call Feature" on Page 86).

---

---

## Using Menu

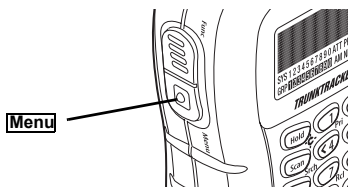

Press **Menu** on the left side of the scanner to enter the menu. See “Using the Menu” on Page 50 for more information about the scanner’s menu options.

## Using Func

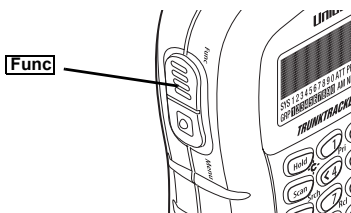

To select the function labeled below a key on the front of the scanner, hold down **Func** on the left side of the scanner, then press that key. To hold on a system while scanning or temporarily stop on a channel while searching, press **Func**. To select a system in Scan or Scan Hold mode, hold down **Func** and rotate the scroll control.

## Using the Scroll Control

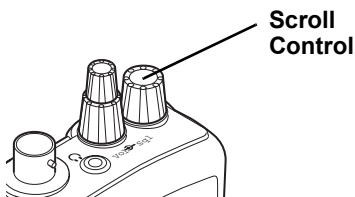

Turn the scroll control on top of the scanner to select a channel or frequency in Hold mode, select menu items in Menu mode, and to select a character while editing a name. You can also press the scroll control down instead of pressing **E** on the keypad to select an item.

## Setting Up Your Scanner



---

---

# Basic Operation

---

---

## Turning On the Scanner and Setting the Squelch

**Note:** Make sure the scanner's antenna is connected before you turn it on.

1. Turn **SqI** fully counterclockwise.
2. Press and hold **⏻** for about 2 seconds to turn on the scanner, then turn **Vol** clockwise until you hear a hissing sound.
3. Turn **SqI** clockwise until the hissing stops.

## Scanning Systems

To begin scanning programmed systems, press **Scan**. The BC246T scans all unlocked systems in all activated quick-key groups.

Notes:

- If no systems are programmed, or all systems are locked out, an error message appears. Program a system or select a system to scan.
- When scanning multiple systems, the BC246T scans systems according to the assigned quick key. Systems assigned to quick key 1 are scanned first, then 2, 3, 4, etc. Systems not assigned to a quick key are scanned last. Within a quick key, systems are scanned in the order they were assigned.
- Within a system, channels are scanned according to the assigned channel group, with the same priority as described above for systems.
- The BC246T scans a system for the duration you set using the System Hold Time option (see "Setting the System Hold Time" on Page 64). For trunked systems, the scanner moves to the next system after the hold time expires, the current transmission ends, and the channel delay expires. Conventional systems operate similarly, but all unlocked channels are scanned at least one time regardless of the hold time setting.

---

---

## ***Preprogrammed System Tips***

All systems preprogrammed into the scanner are assigned to quick key 9. To turn the preprogrammed systems on or off, simply press **9** while scanning.

You can scan preprogrammed systems more efficiently by preventing the BC246T from scanning systems that are not in your area. There are three ways to do this:

- Lock out the faraway systems (see “Locking/Unlocking Systems” on Page 43).
- Reassign your local systems to another quick key (see “Editing the System Quick Key” on Page 63).
- Delete the faraway systems (see “Deleting Systems” on Page 70).

**Important!** You cannot restore preprogrammed systems if you delete them.

## **Selecting Systems to Scan**

To select systems to scan, press **Scan** then press the number button corresponding to the quick key assigned to the system or systems. To stop scanning the system(s), press the number button again.

The SYS indicators on the display show the systems that are currently selected.

To select or lock out a system that is not assigned to a key, press and hold **FUNC** while you rotate the scroll control until the desired system is selected. Then, continue to hold **FUNC** and press **L/O** to either lock out or unlock the system.

## **Selecting System Channel Groups**

Within a system, you can assign groups of channels to a group quick key (see “Setting the Group Quick Key” on Page 72).

Follow these steps to activate or deactivate a channel group within a system while scanning.

- 
- 
1. Press **[Func]** to hold on the system (or hold **[Func]** and rotate the scroll control to select the system).
  2. Continue to hold **[Func]** and press the number key corresponding to the channel group you want to activate or deactivate.

## Locking/Unlocking Systems

Follow these steps to lock out a system so that it does not scan even if its quick key is selected.

1. While holding down **[Func]**, rotate the scroll control to select the system.
2. Continue to hold down **[Func]** and press **L/O** to lock out the system.
3. Repeat Steps 1 and 2 to unlock a system you have previously locked.

## Locking/Unlocking Channels

Follow these steps to lock out a channel so that it does not scan even if its system and channel group are selected.

1. While holding down **[Func]**, rotate the scroll control to select the system where the channel is stored.
2. Release **[Func]** then press **Hold** within 2 seconds to hold on the system.
3. Rotate the scroll control to select the channel you want to lock or unlock.
4. Press **L/O** to lock or unlock the channel.

You can also lock out an active channel by pressing **L/O** while the scanner is stopped on the channel.

## ID Scan/ID Search Mode

While you are scanning a trunked system, the scanner can be in either ID Scan or ID Search mode:

- 
- 
- ID Scan – the scanner only stops on talk group ID's that you have programmed into the system
  - ID Search – the scanner stops on any unlocked talk group that becomes active.

To toggle between ID Scan and ID Search, press **Scan** while the scanner is scanning the system.

## Temporarily Holding On a System

To temporarily hold on a system, press and hold **[Func]**. To hold on a different system, continue to hold **[Func]** and rotate the scroll control to select the system. Normal scanning resumes 2 seconds after you release **[Func]**.

## Holding On a Channel

To hold on a channel, press **Hold** while the channel is active. To select a different channel, rotate the scroll control. If you scroll past the beginning or end of the current system, the scanner selects channels in the previous or next system. To resume scanning, press **Scan**.

## Quickly Storing an ID During ID Search

To quickly store an active talk group ID during ID search, press **E**. You see:

```
QUICK TGID SAVE?  
4128
```

To save the ID into a channel, press **E**. Otherwise, press **No**. If you press **E**, the scanner stores the ID into a channel group called *QCK SAVE GRP* in the current system.

## Quick-Storing Channels or Talk Group ID's

1. Hold on an existing channel in any system.
2. Enter the frequency or talk group ID you want to store (press **•** twice to enter hyphens in talk group ID's).
3. To quick-store the channel or talk group ID, press **E**. Otherwise, press **No**.

**Basic Operation**

---

---

If you enter a frequency then press **E**, the scanner stores it in the *QCK SAVE GRP* group in a system called *QCK SAVE CNV SYS*. These are created if they do not exist. Then, the scanner prompts you to save other channel settings.

If you enter a talk group ID then press **E**, the scanner prompts you to rotate the scroll control to select the system where you want to store the ID. The ID is stored into a channel group named *QCK SAVE GRP* in the selected system. Only systems that match the ID type are shown.

If you pressed **No** in Step 3, the scanner prompts you to select the system and the group where you want to store the frequency or talk group ID.

## Quickly Recalling Channels

1. Press **Hold** to hold on any channel.
2. Press **[Func]** + **Rcl**. The scanner prompts you to select the system where the channel is stored.
3. Rotate the scroll control to select the system, then press **E**. The scanner prompts you to select the channel group where the channel is stored.
4. Rotate the scroll control to select the group, then press **E**. The scanner prompts you to select a channel.
5. Rotate the scroll control to select the channel, then press **E** to hold on that channel.

## Monitoring Trunking Activity

To monitor trunking activity, press **Hold** then turn the scroll control to select the control channel frequency (for a Motorola or EDACS system) or any system frequency (for an LTR system). Active talk group ID's appear on the second line of the display.

---

---

## Other Settings

---

---

### Displaying System Information

#### Viewing Memory Used

**Menu** → ↻ SEE SCANNER INFO → **E** ↻  
% MEMORY USED → **E**

A bar showing the percent of memory used appears.  
Press any key to return to the previous menu.

#### Viewing the Firmware Version

**Menu** → ↻ SEE SCANNER INFO → **E** ↻  
FIRMWARE VERSION → **E**



Press any key to return to the previous menu.

### Adjusting the Key Beep

**Menu** → ↻ ADJUST KEY BEEP → **E**

- **OFF**: The scanner is silent when you press a key.
- **ON**: The scanner beeps when you press a key.

### Locking/Unlocking the Keypad

Press and hold down **Func** then  /  to lock or unlock the keypad.

### Turning Power Save On or Off

**Menu** → ↻ SET BATTERY SAVE → **E**

- **ON**: The scanner goes into low-power mode when you monitor a conventional channel that has no activity.
- **OFF**: Power save is off.

### Priority Scan

**Menu** → ↻ SET PRIORITY → **E**

Or, while holding on any channel, press **Func** + **1/Pri** to select one of these priority modes:

- 
- 
- *PRIORITY OFF*: Normal scanning
  - *PRIORITY ON*: While scanning a conventional system, the scanner interrupts every 2 seconds and checks the priority channels in each unlocked conventional system. Priority channels in lower priority key numbered systems (starting from 1) have highest priority. *PRI* appears when you select this mode.
  - *PRIORITY PLUS*: The scanner only scans priority channels in unlocked conventional systems. *PRI* flashes when you select this mode.

## Using the Backlight

**Menu** → ⏪ *SET BACKLIGHT* → **E**

- *10 SEC* The backlight stays on for 10 seconds after you press 🗑️.
- *30 SEC* The backlight stays on for 30 seconds after you press 🗑️.
- *SQUELCH* The backlight turns on when the squelch opens then stays on for 5 seconds.
- *KEYPRESS* The backlight turns on when any key is pressed then stays on for 10 seconds.
- *INFINITE* The backlight turns on when you press 🗑️ then stays on until you press 🗑️ again.

Pressing any key while the backlight is on extends the backlight period. Pressing 🗑️ while the backlight is on turns off the backlight.

## Initializing the Scanner's Memory

**Important!** This deletes all preprogrammed data. You cannot restore preprogrammed data that has been deleted.

To initialize the scanner's memory, turn off the scanner. Then, press **2, 9,** and **Hold** while turning it on.

## Other Settings

---

---

## Using the PC Control and Cloning Options

Use the included connection cable to connect your scanner to another BC246T scanner or your personal computer.

**Menu** → ↻ *XFER INFORMATION* → **E**

- *PC CONTROL* Lets you set the baud rate your scanner uses to communicate with a personal computer. See “Connecting Your Scanner to a Personal Computer”.
- *CLONE* Lets you set your scanner as a master or a slave, letting you transfer programming to or from another BC246T scanner. See “Cloning the Scanner” on Page 49.

### Connecting Your Scanner to a Personal Computer

To connect your scanner to a personal computer, you must first set the scanner’s baud rate (the rate at which data is transferred between the scanner and the computer, in bits per second (bps)).

Hint: If you have trouble transferring data between your scanner and your computer, try setting the baud rate to a slower setting.

**Menu** → ↻ *XFER INFORMATION* → **E** →

*PC CONTROL* → **E** → ↻

- *OFF* The baud rate is not set.
- *9600 BPS* The baud rate is set to 9600 bps.
- *19200 BPS* The baud rate is set to 19,200 bps.
- *38400 BPS* The baud rate is set to 38,400 bps.
- *57600 BPS* The baud rate is set to 57,600 bps.

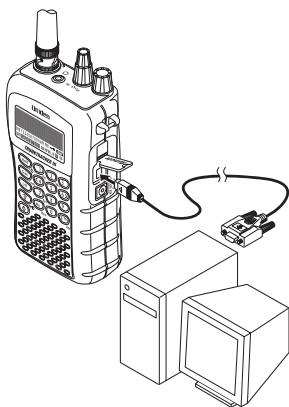

### Other Settings



---

---

## Cloning the Scanner

To clone (copy) data from one BC246T scanner to another BC246T scanner, you must first connect the scanners to each other using the included connection cables and a DB9 null modem adapter and DB9 gender changer (neither included), available at most computer stores. Then you must set one scanner as the master (source) and the other as the slave (destination).

Plug the smaller end of each of the included connection cables into **Remote** on the right side of each scanner. Then connect the other end of the cables together using the null modem connector and gender changer.

Then set up both scanners.

**Menu** → ↻ *XFER INFORMATION* → **E** →

*CLONE* → **E** → ↻

- *MASTER* This will be the master (source) scanner.
- *SLAVE* This will be the slave (destination) scanner.

(Master scanner) *CLONE MASTER PRESS SCAN KEY* → **E**

(Slave scanner) *CLONE SLAVE PRESS SCAN KEY* → **E** →

When you are ready to clone the scanner, press **Scan** on the slave scanner first, then on the master scanner.

The master scanner checks the connection between the two scanners, then transfers its data to the slave scanner.

When the transfer is complete, *COMPLETE* appears on both scanners. If the transfer did not work, *ERROR* appears on the master scanner.

---

---

# Using the Menu

---

---

The scanner's menu lets you select options that let you set up and use the scanner.

To use the menu, press **Menu** on the left side of the scanner. In most cases, the current menu position appears on the upper line of the menu. Menu items and a place to input information appear on the lower line of the menu. To select a menu item, turn the scroll control on top of the scanner clockwise or counterclockwise. When the menu item you want to select appears, press **E** or press the scroll control down to select it. To back up a level or return to the previous level, press **Menu**. To exit the menu mode, press **Scan**.

This table shows the available menu options and where you can find more information about how to use them.

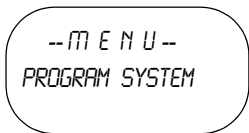
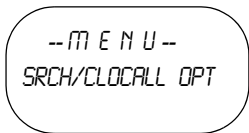
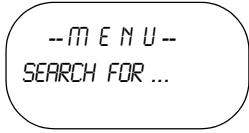
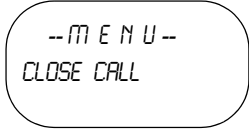
| Menu Item  | Lets You ...                               | See ...                                    |
|--|--|--|
|   | Set up the scanner's scan options.         | "Programming Radio Systems" on Page 52.    |
|  | Set up the scanner's Close Call option.    | "Using the Close Call Feature" on Page 86. |
|  | Set up the scanner's search option.        | "Searching and Storing" on Page 80.        |
|  | Set up the scanner's Close Call operation. | "Setting Close Call Options" on Page 87.   |

| <b>Menu Item</b>                        | <b>Lets You ...</b>   | <b>See ...</b>                              |
|---|---|---|
| <p>--M E N U--<br/>SET PRIORITY</p>     | Set up priority options.                                    | "Priority Scan" on Page 46.                 |
| <p>--M E N U--<br/>WX OPERATION</p>     | Set up weather options.                                     | "Using Weather Alert (SAME)" on Page 94.    |
| <p>--M E N U--<br/>SET BACKLIGHT</p>    | Set up backlight options.                                   | "Using the Backlight" on Page 47.           |
| <p>--M E N U--<br/>ADJUST KEY BEEP</p>  | Set up key beep options.                                    | "Adjusting the Key Beep" on Page 46.        |
| <p>--M E N U--<br/>SET BATTERY SAVE</p> | Set up battery save options.                                | "Turning Power Save On or Off" on Page 46.  |
| <p>--M E N U--<br/>SEE SCANNER INFO</p> | View information about your scanner.                        | "Displaying System Information" on Page 46. |
| <p>--M E N U--<br/>XFER INFORMATION</p> | Transfer information between it and your personal computer. | "Installing the Demo Software" on Page 35.  |

## Using the Menu

---

---

# Programming Radio Systems

---

---

Your BC246T comes preprogrammed with the major analog systems used in the 25 most populous counties in the US. However, to get the most enjoyment from your scanner (especially if you do not live near one of these counties), you must customize the programming for your area.

To edit an existing system, use the menu to navigate to the system setting you want to change. This section assumes you are programming a new system.

Programming radio systems is completed in two major steps. Don't skip either step!

1. Plan the system.
2. Program the system into your scanner according to the plan you prepared in Step 1.

To make planning easier, planning worksheets are included in the back of this manual for each system type. Copy the worksheets (or download this manual from the Uniden America Corporation website and print extra sheets), then use them to plan out how you will program the scanner.

**Important!** Before you start programming your scanner, make sure the batteries are fresh or fully charged. If the scanner loses power while you program it, its memory might be corrupted which will require you to reinitialize it (see "Initializing the Scanner's Memory" on Page 47). All information programmed in the scanner, including preprogrammed systems, might be lost.

## General Notes

- You can store up to 200 systems.
- Trunking systems can have up to 200 channels each. The number of conventional system channels you can have is limited only by the amount of scanner memory remaining.
- You can store up to 20 channel groups per system.
- Total channels are limited to about 2500.
- Channels that have text tags use more memory than those that do not. If you use a text tag for every channel, total channels are reduced from 2500 (1600 is typical).

## Programming Radio Systems

---

---

## Programming Conventional Systems

**Menu** → PROGRAM SYSTEM → E ↻  
NEW SYSTEM → E → CONVENTIONAL →  
E → CONFIRM? → E

The scanner creates an empty conventional system, with a default name of *SYSTEM MNN C*. *MNN* increments as you add new systems. *C* indicates that this is a conventional system.

Refer to the appropriate section to set system-wide options:

- See “Editing the System Name” on Page 63
- See “Editing the System Quick Key” on Page 63
- See “Setting System Lockout” on Page 64
- See “Setting the System Hold Time” on Page 64
- See “Setting the Channel Delay Time” on Page 65
- See “Setting Data Skip (Conventional Systems Only)” on Page 66
- See “Deleting Systems” on Page 70
- See “Copying Systems” on Page 71
- See “Entering/Editing Conventional Channel Groups” on Page 53

### ***Entering/Editing Conventional Channel Groups***

To enter channels in a conventional system, first set up a channel group (or groups) to hold the channels. Then, enter the channel and channel parameters in the group(s).

#### **Setting Up a Channel Group**

↻ → EDIT GROUP → E →  
↻ → NEW GROUP → E

The scanner creates a group with a default name of *GROUP NN*. *NN* increments by one for each new group you create within a system.

## Programming Radio Systems

---

---

Refer to the appropriate section to set group-wide options:

- See “Entering/Editing the Group Name” on Page 71
- See “Setting the Group Quick Key” on Page 72
- See “Deleting Groups” on Page 73
- See “Setting System Lockout” on Page 64
- See “Entering/Editing Conventional Channels” on Page 54

## ***Entering/Editing Conventional Channels***

↻ → *EDIT CHANNEL* → **E** →

↻ → *NEW CHANNEL* → **E** → *INPUT FREQUENCY*

Enter the frequency for the channel, then press **E**. Then, refer to the appropriate section to change a channel setting:

- See “Editing the Channel Name” on Page 73
- See “Setting Channel Priority (Conventional Channels Only)” on Page 74
- See “Setting Channel Alert” on Page 74
- See “Deleting Channels” on Page 78
- See “Copying/Pasting Channels” on Page 79

To program another channel within the same group, press **Menu**, then repeat the above.

To create another channel group and enter more channels, press **Menu** four times, then proceed from “Setting Up a Channel Group” on Page 53.

## **Programming Motorola Systems**

**Menu** → *PROGRAM SYSTEM* → **E** ↻

*NEW SYSTEM* → **E** → *MOT* → **E**

Next, rotate the scroll control to select the type of Motorola system you want to program, then press **E**.

## **Programming Radio Systems**

- 
- 
- *800MHZ STANDARD* - Use for 800 MHz systems that use the standard band plan
  - *800MHZ SPLINTER* - Use for 800 MHz systems that use the splinter band plan (typically near international borders)
  - *900MHZ BAND* - Use for 900 MHz systems
  - *VHF BAND* - Use for VHF systems
  - *UHF BAND* - Use for UHF systems

Next, refer to the appropriate section to set system-wide options. For most settings, you can accept the default. However, for the items in **bold**, you must enter information in order for your scanner to scan the system.

- See “Editing the System Name” on Page 63
- See “Editing the System Quick Key” on Page 63
- See “Setting System Lockout” on Page 64
- See “Setting the System Hold Time” on Page 64
- See “Setting the Channel Delay Time” on Page 65
- See “Setting ID Scan/Search (Trunked Systems Only)” on Page 65
- See “Editing the Fleet Map (Motorola Systems Only)” on Page 66 (**must be set up for Type I systems**)
- See “Setting the Motorola Status Bit (Motorola Systems Only)” on Page 67
- See “Setting the End Code Operation (Motorola Systems Only)” on Page 67
- See “Setting I-Call (Motorola and EDACS Systems Only)” on Page 68
- See “Setting Emergency Alert (Motorola and EDACS Systems Only)” on Page 68
- See “Setting Control-Channel Only (Motorola Systems Only)” on Page 69
- See “Setting System Lockout” on Page 64
- See “Reviewing Locked Out Frequencies” on Page 89
- See “Setting System Attenuation (Trunked Systems Only)” on Page 70

## Programming Radio Systems

- 
- 
- See “Deleting Systems” on Page 70
  - See “Copying Systems” on Page 71
  - **See “Setting System Frequencies” on Page 56**
  - **See “Entering/Editing Motorola Channel Groups” on Page 56**

## **Setting System Frequencies**

SET FREQUENCIES → E

↻ NEW FREQUENCY → E

Input a system frequency, then press E.

To enter additional frequencies, press **Menu**, use the scroll control to select *NEW FREQUENCY*, then repeat the above.

Note: If you select Control Channel Only mode (see “Setting Control-Channel Only (Motorola Systems Only)” on Page 69), you only need to enter the frequency(s) that can be assigned as the control channel. Most frequency lists usually indicate which of the frequencies are the control channel frequencies. Otherwise, you must enter all of the frequencies.

## **Entering/Editing Motorola Channel Groups**

To enter channels in a system, first set up a channel group (or groups) to hold the channels. Then, enter the channel and channel parameters in the group(s).

### **Setting Up a Channel Group**

↻ EDIT GROUP → E ↻ NEW GROUP → E

The scanner creates a group with a default name of *GROUP NN*. *NN* increments by one for each new group you create within a system.

Next, refer to the appropriate section to set group-wide options:

- See “Entering/Editing the Group Name” on Page 71
- See “Setting the Group Quick Key” on Page 72

## **Programming Radio Systems**



- 
- 
- See “Deleting Groups” on Page 73
  - See “Copying Systems” on Page 71
  - See “Entering/Editing Motorola Channels” on Page 57

## ***Entering/Editing Motorola Channels***

↻ EDIT CHANNEL → **E**

↻ NEW CHANNEL → **E** INPUT TGID

Enter the Talk Group ID for the channel, then press **E**.

Notes:

- Motorola Type 2 Talk Group ID's are entered as 5-digit numbers.
- Motorola Type 1 Talk Group ID's are entered as two numbers separated by a hyphen. Use the decimal point to enter the hyphen.
- To enter an I-Call ID, press **•**, then enter the ID. The **•** appears as an **i** when entering the ID, but it appears as a seven (7) when it is active on a Type 2 system.

Then, refer to the appropriate section to change a channel setting:

- See “Setting Emergency Alert (Motorola and EDACS Systems Only)” on Page 68
- See “Editing the Channel Name” on Page 73
- See “Setting Channel Alert” on Page 74
- See “Setting Channel Lockout” on Page 78
- See “Deleting Channels” on Page 78
- See “Copying/Pasting Channels” on Page 79

To program another channel within the same group, press **Menu**, then repeat the above.

To create another channel group and enter more channels, press **Menu** three times, then proceed from “Entering/Editing Motorola Channel Groups” on Page 56.

---

---

## Programming EDACS Systems

**Menu** → PROGRAM SYSTEM → **E** ↻

NEW SYSTEM → **E** ↻ EDACS → **E**

Next, rotate the scroll control to select the type of EDACS system you will program, then press **E**.

- *WIDE* - Use for wideband EDACS systems
- *NARROW* - Use for narrowband EDACS systems
- *SCAT* - Use for EDACS SCAT (Single Channel Autonomous Trunking)

When the scanner prompts *CONFIRM?*, press **E** to accept the settings. The scanner creates an empty EDACS system, with a default name of *SYSTEM NNN E*. *NNN* increments as you add new systems. The *E* indicates that this is an EDACS system.

Next, refer to the appropriate section to set system-wide options. For most settings, you can accept the default. However, for the items in **bold**, you must enter information in order for your scanner to scan the system.

- See “Editing the System Name” on Page 63
- See “Editing the System Quick Key” on Page 63
- See “Setting System Lockout” on Page 64
- See “Setting the System Hold Time” on Page 64
- See “Setting the Channel Delay Time” on Page 65
- See “Setting ID Scan/Search (Trunked Systems Only)” on Page 65
- See “Setting I-Call (Motorola and EDACS Systems Only)” on Page 68
- See “Setting Emergency Alert (Motorola and EDACS Systems Only)” on Page 68
- See “Setting the EDACS ID Format (EDACS Systems Only)” on Page 69
- See “Reviewing Locked Out Frequencies” on Page 89
- See “Setting Channel Attenuation (Conventional Channels Only)” on Page 76

## Programming Radio Systems

- 
- 
- See “Deleting Systems” on Page 70
  - See “Copying Systems” on Page 71
  - **See “Setting System Frequencies” on Page 59**
  - **See “Entering/Editing EDACS Channel Groups” on Page 59**

## **Setting System Frequencies**

*SET FREQUENCIES* → **E** →

↻ → *NEW FREQUENCY* → **E**

Input a system frequency, then press **E**. The scanner then prompts you to enter the LCN for the entered frequency. Enter the LCN, then press **E**.

To enter additional frequencies, press **Menu**, scroll to *NEW FREQUENCY*, then repeat the above.

Note: The scanner only accepts a single frequency and no LCN for SCAT systems.

## **Entering/Editing EDACS Channel Groups**

To enter channels in a system, first set up a channel group (or groups) to hold the channels. Then, enter the channel and channel parameters in the group(s).

### **Setting Up a Channel Group**

↻ → *EDIT GROUP* → **E** →

↻ → *NEW GROUP* → **E**

The scanner creates a group with a default name of *GROUP NN*. *NN* increments by one for each new group you create within a system.

Next, refer to the appropriate section to set group-wide options:

- See “Entering/Editing the Group Name” on Page 71
- See “Setting the Group Quick Key” on Page 72
- See “Deleting Groups” on Page 73
- See “Editing the Channel Name” on Page 73
- See “Setting Group Lockout” on Page 72

---

---

## Entering/Editing EDACS Channels

↻ → *EDIT CHANNEL* → **E** →

↻ → *NEW CHANNEL* → **E** → *INPUT TGID*

Enter the talk group ID for the channel, then press **E**.

Notes:

- If you have selected to use AFS format for talk group ID's (the default), press **•** to enter a hyphen.
- To enter an I-Call ID, press **•**, then enter the ID.
- If you omit the fleet and/or subfleet, the scanner treats these fields as wildcards.

Note: Press **•** to enter a hyphen.

Then, refer to the appropriate section to change a channel setting:

- See “Editing the Channel Name” on Page 73
- See “Setting Channel Alert” on Page 74
- See “Setting Channel Lockout” on Page 78
- See “Deleting Channels” on Page 78
- See “Copying/Pasting Channels” on Page 79

To program another channel within the same group, press **Menu**, then repeat the above. To create another channel group and enter more channels, press **Menu** three times, then proceed from “Entering/Editing EDACS Channel Groups” on Page 59.

## Programming LTR Systems

**Menu** → *PROGRAM SYSTEM* → **E** ↻

*NEW SYSTEM* → **E** → *LT* →

**E** → *CONFIRM?* → **E**

When the scanner prompts *CONFIRM?*, press **E** to accept the settings. The scanner creates an empty LTR system, with a default name of *SYSTEM NNN L*.

*NNN* increments as you add new systems. *L* indicates that this is an LTR system.

## Programming Radio Systems

---

---

Next, refer to the appropriate section to set system-wide options. For most settings, you can accept the default. However, for the items in **bold**, you must enter information in order for your scanner to scan the system.

- See “Editing the System Name” on Page 63
- See “Setting the System Hold Time” on Page 64
- See “Editing the System Quick Key” on Page 63
- See “Setting the Channel Delay Time” on Page 65
- See “Setting ID Scan/Search (Trunked Systems Only)” on Page 65
- See “Reviewing Locked Out Frequencies” on Page 89
- See “Setting Channel Attenuation (Conventional Channels Only)” on Page 76
- See “Deleting Systems” on Page 70
- See “Copying Systems” on Page 71
- **See “Setting System Frequencies” on Page 61**
- **See “Entering/Editing LTR Channel Groups” on Page 61**

## ***Setting System Frequencies***

*SET FREQUENCIES* → **E**

↻ *NEW FREQUENCY* → **E**

Input a system frequency, then press **E**. The scanner then prompts you to enter the LCN for the entered frequency. Enter the LCN, then press **E**.

To enter additional frequencies, press **Menu**, use the scroll control to select *NEW FREQUENCY*, then repeat the above.

## ***Entering/Editing LTR Channel Groups***

To enter channels in a system, first set up a channel group (or groups) to hold the channels. Then, enter the channel and channel parameters in the group(s).

---

---

## Setting Up a Channel Group

↻ → *EDIT GROUP* → **E** →

↻ → *NEW GROUP* → **E**

The scanner creates a group with a default name of *GROUP NN*. *NN* increments by one for each new group you create within a system.

Next, refer to the appropriate section to set group-wide options:

- See “Entering/Editing the Group Name” on Page 71
- See “Setting the Group Quick Key” on Page 72
- See “Setting Group Lockout” on Page 72
- See “Deleting Groups” on Page 73
- See “Entering/Editing LTR Channels” on Page 62

## Entering/Editing LTR Channels

↻ → *EDIT CHANNEL* → **E** →

↻ → *NEW CHANNEL* → **E** →

*INPUT TGID*

Enter the talk group ID for the channel, then press **E**.

Note: Press • to enter a hyphen.

Then, refer to the appropriate section to change a channel setting:

- See “Editing the Channel Name” on Page 73
- See “Setting Channel Alert” on Page 74
- See “Setting Channel Lockout” on Page 78
- See “Deleting Channels” on Page 78
- See “Copying/Pasting Channels” on Page 79

To program another channel within the same group, press **Menu**, then repeat the above.

To create another channel group and enter more channels, press **Menu** four times, then proceed from “Setting Up a Channel Group” on Page 62.

---

---

## Programming/Editing Optional Settings

---

---

This section details the instructions for each of the optional programming steps referred to in “Programming Radio Systems” on Page 52. Use the instructions in the appropriate section to enter or edit a setting.

### System-Level Settings

These settings apply to the entire system.

#### *Editing the System Name*

**Menu** → PROGRAM SYSTEM → **E** ↻

Select the system → **E**

EDIT NAME → **E**

Follow these steps to enter/edit the system name.

1. Rotate the scroll control to select the first letter.
2. Press and hold down **Func** then rotate the scroll control once to select the next letter.
3. Repeat Steps 1 and 2 until you have entered the system name. Then press **E** or press down on the scroll control to accept the setting.

Hints:

- Each system name can be up to 16 characters. Abbreviate as necessary to fit.
- The default system names include the following letter in the 16th position to indicate the system type:

**M** = Motorola

**E** = EDACS

**L** = LTR

**C** = Conventional

- Press **•** twice to delete the current character.
- Press **•** three times to clear the entire alpha tag.

#### *Editing the System Quick Key*

**Menu** → PROGRAM SYSTEM → **E** ↻

Select the system → **E** ↻

## Programming/Editing Optional Settings

---

---

*EDIT SYS OPTION* → **E** ↻

*SET QUICK KEY* → **E**

After selecting this option, press **0-9** to assign the system to a quick key or press **No** to assign the system to no quick key, then press **E**.

Hints:

- You can assign as many systems to the same quick key as you want.
- Preprogrammed systems are set to quick key 9.
- To be scanned, a system's quick key must be activated and the system must be unlocked.

## **Setting System Lockout**

**Menu** → *PROGRAM SYSTEM* → **E** ↻

Select the system → **E** ↻

*EDIT SYS OPTION* → **E** ↻

*SET LOCKOUT* → **E**

This setting controls whether the system is scanned when its quick key is enabled. Rotate the scroll control to select your setting, then press **E**.

*LOCKED* - the system is not scanned

*UNLOCKED* - the system is scanned

Note: You can also lock or unlock a system by pressing **Func**, selecting the system, then pressing **Func** + **L/O**.

## **Setting the System Hold Time**

**Menu** → *PROGRAM SYSTEM* → **E** ↻

Select the system → **E** ↻

*EDIT SYS OPTION* → **E** ↻

*SET HOLD TIME* → **E**

This setting controls how many seconds the scanner scans a system before moving to the next unlocked system. Enter a value from 0-255, then press **E** to save the setting.

## **Programming/Editing Optional Settings**



---

---

## Notes:

- If you select 0, the scanner stays on the system for a minimal time (only long enough to check current system activity).
- The default setting is 2 seconds for each system.
- For conventional systems, all unlocked channels will be scanned at least once regardless of this setting.
- The scanner moves to the next system after the hold time expires, any current transmission ends, and the channel delay time expires.

## **Setting the Channel Delay Time**

**Menu** → PROGRAM SYSTEM → E ↻

Select the system → E ↻

EDIT SYS OPTION → E ↻

SET DELAY TIME → E

This setting controls how many seconds the scanner waits after a transmission ends before resuming scanning. Enter a value from 1-5 or OFF, then press E.

## Notes:

- The default setting is 2 seconds for each system.
- This setting applies to all channels within the system.

## **Setting ID Scan/Search (Trunked Systems Only)**

**Menu** → PROGRAM SYSTEM → E ↻

Select the system → E ↻

EDIT SYS OPTION → E ↻

ID SCAN/SEARCH → E

This setting controls how the system will be scanned. Select your setting, then press E.

ID SCAN - the scanner only stops on channels you have programmed into the system.

## **Programming/Editing Optional Settings**

---

---

*ID SEARCH* - the scanner stops on any transmission for unlocked talk group ID's.

Note: You can also change this setting by pressing **Scan** while scanning the system.

## **Setting Data Skip (Conventional Systems Only)**

**Menu** → *PROGRAM SYSTEM* → **E** ↻

Select the system → **E** ↻

*EDIT SYS OPTION* → **E** ↻

*SET DATA SKIP* → **E**

This setting controls how the scanner behaves when it stops on a channel that has a data signal.

*ON* - the scanner stops briefly on the channel, but then immediately resumes scanning automatically. Press **E** to select.

*OFF* - the scanner remains on the channel until the transmission stops. Press **E** to select.

Notes:

- This setting is ignored for AM channels.
- The default setting for this feature is *ON*.

## **Editing the Fleet Map (Motorola Systems Only)**

**Menu** → *PROGRAM SYSTEM* → **E** ↻

Select the system → **E** ↻

*EDIT SYS OPTION* → **E** ↻

*EDIT FLEET MAP* → **E**

For Motorola Type I systems, you must enter a system fleet map in order for the scanner to properly track and display talk group ID's. The fleet map is usually included in the same resource that provided system frequencies and talk group ID lists.

## **Programming/Editing Optional Settings**

---

---

Rotate the scroll control to select the fleet map:

*PRESET* - select from the 16 most common fleet maps (see "Preset Fleet Maps" on Page 105). Press **E** to select.

*CUSTOM* - allows you to enter a custom fleet map. Enter the size code for each block. Press **E** to select.

Notes:

- If you don't know the fleet map for your Motorola Type I system, check the Internet. This information is commonly posted on sites such as those we reference in "Where To Get More Information" on Page 27.
- The default setting of no fleet map is the correct setting for Motorola Type II systems.

## **Setting the Motorola Status Bit (Motorola Systems Only)**

**[Menu]** → *PROGRAM SYSTEM* → **E** ↻

Select the system → **E** ↻

*EDIT SYS OPTION* → **E** ↻

*SET STATUS BIT* → **E**

Motorola systems use talk group ID's in multiples of 16. ID numbers that fall between these ID's indicate special status flags for the system. This setting determines how the scanner will handle ID's that are not multiples of 16. Select your setting then press **E**.

*IGNORE* - the scanner rounds all received ID's down to the next interval of 16.

*YES* - the scanner treats all received ID's as unique ID's.

Note: The default setting is *IGNORE*.

## **Setting the End Code Operation (Motorola Systems Only)**

**[Menu]** → *PROGRAM SYSTEM* → **E** ↻

Select the system → **E** ↻

## **Programming/Editing Optional Settings**

---

---

EDIT SYS OPTION → E ↻

SET END CODE → E

This setting determines how the scanner handles the transmission end code sent by most Motorola systems. Select your setting then press **E**.

*YES* - the scanner immediately returns to the control channel when it detects the end code.

*IGNORE* - the scanner does not return to the control channel until the carrier drops.

Note: The default setting is *YES*.

## **Setting I-Call (Motorola and EDACS Systems Only)**

**Menu** → PROGRAM SYSTEM → E ↻

Select the system → E ↻

EDIT SYS OPTION → E ↻

SET I CALL → E

I-calls are direct "individual" radio calls made from one radio to another. This setting determines how your scanner treats I-calls while ID Searching.

*ON* - the scanner tracks I-calls. Press **E** to select.

*OFF* - the scanner ignores I-calls. Press **E** to select.

*ONLY* - the scanner only tracks I-calls and ignores other radio traffic on the system. Press **E** to select.

Note: The default setting is *OFF*.

## **Setting Emergency Alert (Motorola and EDACS Systems Only)**

**Menu** → PROGRAM SYSTEM → E ↻

Select the system → E ↻

EDIT SYS OPTION → E ↻

SET EMERGENCY ALERT → E

## **Programming/Editing Optional Settings**

---

---

This setting determines how your scanner handles radio traffic that has the emergency flag set. Select your setting then press **E**.

*ALERT* - the scanner sounds an alert beep to notify you of the emergency transmission.

*IGNORE* - the scanner does not alert you to emergency transmissions.

Note: The scanner defaults to *IGNORE*.

## **Setting the EDACS ID Format (EDACS Systems Only)**

**Menu** → PROGRAM SYSTEM → **E** ↻

Select the system → **E** ↻

EDIT SYS OPTION → **E** ↻

EDACS ID FORMAT → **E**

EDACS talk group ID's are commonly provided in one of two formats: AFS and Decimal. This setting determines how you enter EDACS ID's and how the scanner displays them.

*AFS FORMAT* - the scanner uses AFS format for talk group ID's

*DECIMAL FORMAT* - the scanner uses decimal format for talkgroup ID's

Notes:

- The scanner defaults to AFS (agency, fleet, subfleet) format - the format used in most EDACS systems.
- See "EDACS Trunking" on Page 25 for more information about the AFS format.

## **Setting Control-Channel Only (Motorola Systems Only)**

**Menu** → PROGRAM SYSTEM → **E** ↻

Select the system → **E** ↻

EDIT SYS OPTION → **E** ↻

SET C-CH ONLY → **E**

---

---

This setting determines the frequencies you need to enter for Motorola systems. Select your setting, then press **E**.

*OFF* - you must enter all voice and control channel frequencies.

*ON* - you only need to enter control channel frequencies.

Note: The scanner defaults to *OFF*.

## **Setting System Attenuation (Trunked Systems Only)**

**Menu** → PROGRAM SYSTEM → **E** ↻

Select the system → **E** ↻

SET ATTENUATION → **E**

This setting controls whether the attenuator will be on or off for the current system. Select your setting then press **E**.

*OFF* - the attenuator is off.

*ON* - system frequencies are attenuated by about 18 dB.

Notes:

- Turn on this setting if you are near strong signal sources. Attenuation can help reduce interference and desensitization that strong signals create.
- You can also turn this setting on or off by holding on a trunked system, then pressing **Func** + **E**.

## **Deleting Systems**

**Menu** → PROGRAM SYSTEM → **E** ↻

Select the system → **E** ↻

DELETE SYSTEM → **E**

The scanner prompts you to confirm deletion. To confirm, press **E**. To cancel, press **No**.

Notes:

- Deleted systems cannot be restored. You must re-enter them.
- You cannot restore preloaded systems.

## **Programming/Editing Optional Settings**

---

---

## Copying Systems

To copy a system including all settings, groups, and channels:

**Menu** → PROGRAM SYSTEM → E ↻

Select the system → E ↻

COPY SYSTEM → E → NEW SYS NAME

Enter a name for the copied system, then press E.

## Group-Level Settings

The settings in this section apply to all of the channels stored in the current group.

### Entering/Editing the Group Name

**Menu** → PROGRAM SYSTEM → E ↻

Select the system → E ↻

EDIT GROUP → E ↻

Select the group → E

EDIT NAME → E

Follow these steps to enter/edit the group name.

1. Rotate the scroll control to select the first letter.
2. Press and hold down **Func** then rotate the scroll control once to select the next letter.
3. Repeat Steps 1 and 2 until you have entered the system name. Then press **E** or press down on the scroll control to accept the setting.

Hints:

- Each group name can be up to 16 characters. Abbreviate as necessary to fit.
- The group and system name alternate in the top line of the display when the scanner stops on a channel.
- Press • twice to delete the current character.
- Press • three times to clear the entire alpha tag.

## Programming/Editing Optional Settings

---

---

## Setting the Group Quick Key

**Menu** → PROGRAM SYSTEM → E ↻

Select the system → E ↻

EDIT GROUP → E ↻

Select the group → E ↻

SET QUICK KEY → E

After selecting this option, press **0-9** to assign the group to a quick key or press **No** to assign the system to no quick key, then press **E**.

Hints:

- You can assign as many groups to the same quick key as you want.
- To be scanned, a group's quick key must be activated.

## Setting Group Lockout

**MENU** → PROGRAM SYSTEM → E ↻

Select the system → E ↻

EDIT GROUP → E ↻

Select the group → E ↻

SET LOCKOUT → E

This setting determines whether the scanner will scan this group when it is enabled. Select your setting, then press **E**.

*LOCKOUT* - the group is not scanned.

*UNLOCKED* - the group is scanned.

Note: The default setting is Unlocked.



---

---

## Deleting Groups

**[Menu]** → PROGRAM SYSTEM → **E** ↻

Select the system → **E** ↻

EDIT GROUP → **E** ↻

Select the group → **E** ↻

DELETE GROUP → **E**

The scanner prompts you to confirm deletion. To confirm, press **E**. To cancel, press **No**.

Note: Deleted groups cannot be restored. You must re-enter them.

## Channel-Level Settings

These settings affect only the channel you are programming.

### Editing the Channel Name

**[Menu]** → PROGRAM SYSTEM → **E** ↻

Select the system → **E** ↻

EDIT GROUP → **E** ↻

Select the group → **E** ↻

EDIT CHANNEL → **E** ↻

Select the channel → **E**

EDIT NAME → **E**

Follow these steps to enter/edit the channel name.

1. Rotate the scroll control to select the first letter.
2. Press and hold down **[Func]** then rotate the scroll control once to select the next letter.
3. Repeat Steps 1 and 2 until you have entered the channel name. Then press **E** or press down on the scroll control to accept the setting.

Hints:

- Each channel name can be up to 16 characters. Abbreviate as necessary to fit.

## Programming/Editing Optional Settings

- The channel name appears on the second line of the display when the scanner stops on a channel.
- If you do not enter a channel name, the scanner displays the frequency (for conventional systems) or the talk group ID (for trunked systems) when it stops on a channel.
- Press **E** twice to delete the current character.
- Press **E** three times to clear the entire alpha tag.
- Channel names take up extra memory. To maximize channels, use channel names only where necessary.

## **Setting Channel Priority (Conventional Channels Only)**

**Menu** → PROGRAM SYSTEM → **E** ↻

Select the system → **E** ↻

EDIT GROUP → **E** ↻

Select the group → **E** ↻

EDIT CHANNEL → **E** ↻

Select the channel → **E** ↻

SET PRIORITY → **E**

This setting controls whether the scanner treats the channel as a priority channel while scanning. Select your setting, then press **E**.

*ON* - when you turn on the Priority feature, the channel will be scanned every 2 seconds. *P* appears at the end of the default name.

*OFF* - the channel will not be treated with priority.

Note: The default setting is *OFF*.

## **Setting Channel Alert**

**Menu** → PROGRAM SYSTEM → **E** ↻

Select the system → **E** ↻

EDIT GROUP → **E** ↻

Select the group → **E** ↻

## **Programming/Editing Optional Settings**

---

---

*EDIT CHANNEL* → **E** ↻

Select the channel → **E** ↻

*SET ALERT* → **E**

This setting controls whether the scanner will alert you when the channel becomes active. Select your setting, then press **E**.

*ON* - the scanner beeps when the channel becomes active.

*OFF* - no alert sounds.

Note: The default setting is *OFF*.

## **Setting CTCSS/DCS (Conventional Channels Only)**

**Menu** → *PROGRAM SYSTEM* → **E** ↻

Select the system → **E** ↻

*EDIT GROUP* → **E** ↻

Select the group → **E** ↻

*EDIT CHANNEL* → **E** ↻

Select the channel → **E** ↻

*SET CTCSS/DCS* → **E**

This setting controls how a subaudible CTCSS or DCS is used for the channel. Select your setting, then press **E**.

*OFF* - any signal opens squelch.

*SEARCH* - the scanner searches for and displays any CTCSS or DCS tone that accompanies the transmission.

*CTCSS* - the scanner only opens squelch if the CTCSS tone you select is also present with the signal. The scanner then prompts you to enter or scroll to the desired tone.

*DCS* - the scanner only opens squelch if the DCS tone you select is also present with the signal. The scanner then prompts you to enter or scroll to the desired tone.

*SET LOCKOUT* - the scanner does not stop on the channel if the tone you select is present. The scanner prompts you to select a CTCSS or DCS tone.

## **Programming/Editing Optional Settings**

---

---

Notes:

- The default setting is *OFF*.
- See “What is CTCSS/DCS?” on Page 19 for a complete list of CTCSS and DCS tones.

## **Setting Channel Modulation (Conventional Channels Only)**

**Menu** → PROGRAM SYSTEM → E ↻

Select the system → E ↻

EDIT GROUP → E ↻

Select the group → E ↻

EDIT CHANNEL → E ↻

Select the channel → E ↻

SET MODULATION → E

This setting controls the demodulation method used for the channel. Select your setting, then press **E**.

*AUTO* - the scanner uses the default modulation for the frequency (see the table at the front of the manual).

*AM* - the scanner uses AM (amplitude modulation) for the frequency.

*FM* - the scanner uses FM (frequency modulation) for the frequency.

*NFM* - the scanner uses narrowband FM for the frequency.

Note: The default setting is *AUTO*.

## **Setting Channel Attenuation (Conventional Channels Only)**

**Menu** → PROGRAM SYSTEM → E ↻

Select the system → E ↻

EDIT GROUP → E ↻

Select the group → E ↻

## **Programming/Editing Optional Settings**

---

---

*EDIT CHANNEL* → **E** ↻

Select the channel → **E** ↻

*SET ATTENUATOR* → **E**

This setting controls whether the scanner attenuates signals on this channel. Select your setting, then press **E**.

*ON* - the channel is attenuated by about 18 dB.

*OFF* - the channel is not attenuated.

Notes:

- The default setting is *OFF*.
- For trunked systems, the attenuation is a system-level setting.
- You can also toggle this setting by holding on the channel and pressing **[Func]** and **E**.

## ***Setting the Frequency Step (Conventional Channels Only)***

**[Menu]** → *PROGRAM SYSTEM* → **E** ↻

Select the system → **E** ↻

*EDIT GROUP* → **E** ↻

Select the group → **E** ↻

*EDIT CHANNEL* → **E** ↻

Select the channel → **E** ↻

*SET STEP* → **E**

This setting selects the frequency step used for setting the channel's. Select your setting, then press **E**.

*AUTO* - the step is based on the band (see the table at the front of the manual)

*5.0 KHZ, 6.25 KHZ, 7.5 KHZ, 10.0 KHZ, 12.5 KHZ, 15.0 KHZ,  
20.0 KHZ, 25.0 KHZ, 50.0 KHZ, 100.0 KHZ* - The scanner uses the selected step.

Note: The scanner defaults to *AUTO*.

---

---

## Setting Channel Lockout

**MENU** → PROGRAM SYSTEM → **E** ↻

Select the system → **E** ↻

EDIT GROUP → **E** ↻

Select the group → **E** ↻

EDIT CHANNEL → **E** ↻

Select the channel → **E** ↻

SET LOCKOUT → **E**

This setting determines whether the scanner will scan this channel when its system and group are enabled. Select your setting, then press **E**.

*LOCKOUT* - the channel is not scanned.

*UNLOCKED* - the channel is scanned.

Notes:

- The default setting is Unlocked.
- You can also lock or unlock a channel by selecting it while scanning or holding, then pressing **L/O**. See "Basic Operation" on Page 41.

## Deleting Channels

**Menu** → PROGRAM SYSTEM → **E** ↻

Select the system → **E** ↻

EDIT GROUP → **E** ↻

Select the group → **E** ↻

EDIT CHANNEL → **E** ↻

Select the channel → **E** ↻

DELETE CHANNEL → **E**

The scanner prompts you to confirm deletion. To confirm, press **E**. To cancel, press **No**.

Note: Deleted channels cannot be restored. You must re-enter them.

---

---

## ***Copying/Pasting Channels***

To copy a channel including all settings:

**[Menu]** → *PROGRAM SYSTEM* → **E** ↻

Select the system → **E** ↻

*EDIT GROUP* → **E** ↻

Select the group → **E**

*EDIT CHANNEL* → **E** ↻

Select the channel → **E**

*COPY CHANNEL* → **E**

The scanner copies the channel into a copy buffer.

To paste the channel into the same or another system:

**[Menu]** → *PROGRAM SYSTEM* → **E** ↻

Select the system → **E** ↻

*EDIT GROUP* → **E** ↻

Select the group → **E**

*EDIT CHANNEL* → **E** ↻

Select the channel → ↻

*PASTE CHANNEL* → **E**

Then, if necessary, edit the channel you copied to give it a unique name and other settings.

Note: The paste option appears only if you have previously copied a channel from a system of the same type you are currently editing.

---

---

# Searching and Storing

---

---

## Service Search

Service Search lets you quickly select and search the scanner's preprogrammed search ranges. During service search, the scanner searches starting with the lowest frequency in the search range you select to the highest frequency in the range.

1. Press **Menu** then turn the scroll control until *SEARCH FOR . . .* appears. Then press **E**. Or press **Func** and **Srch**, then **No**. The search feature options appear.
2. Turn the scroll control until *SERVICE SEARCH* appears, then press **E** to select it.
3. Turn the scroll control until the type of service search you want appears, then press **E** to select it. The following search bands appear.

*PUBLIC SAFETY  
NEWS  
HAM RADIO  
MARINE  
RAILROAD  
AIR  
CB RADIO  
FRS/GMRS  
RACING  
SPECIAL*

The scanner searches the service you selected, stopping on any transmission it finds and displaying the frequency. Turn the scroll control to change the search direction. An arrow appears, showing the current search direction.

To hold searching, press **Hold**. To resume searching, press **Func** then press **Scan/Srch**. Or, press **Hold**.

To lock out a frequency found while searching, press **L/O**. *SEARCH LOCKOUT?* appears. Press **E** to lock out the frequency or **No** to continue monitoring.

Notes:

- If all frequencies in the search band you selected are locked out, *ALL LOCKED!* appears and the scanner does not search the band.

## Searching and Storing



- 
- 
- If the service you select uses channels (such as CB radio or marine), the scanner displays the service channel number.

## Quick Search

Quick Search lets you search from the currently-tuned frequency if you are scanning a conventional system or sets the system to ID search if you are scanning a trunked system.

If you are on a conventional system or channel, press **[Func]** and **Scan/Srch** to start quick search. *QUICK SEARCH?* appears. *QUICK SEARCH MODE* appears if you press **Hold**. Press **E** to start quick search or **No** to go to the search menu.

## CTCSS/DCS Search

CTCSS/DCS Search lets you search for CTCSS or DCS tones when it finds an active frequency in search and Close Call modes. You can identify up to 50 CTCSS tones and 104 DCS codes.

Turning this option on lets the scanner search for CTCSS/DCS tones. If the scanner detects the tone, it displays the tone's frequency and DCS code.

1. Press **[Menu]** then turn the scroll control until *SRCH/CLOCALL OPT* appears. Then press **E**. One of the search feature options appear.
2. Turn the scroll control until *CTCSS/DCS SEARCH* appears, then press **E** to select it.
3. Turn the scroll control until *ON* appears to turn on CTCSS/DCS search or until *OFF* appears to turn it off, then press **E**.

## Custom Search

Custom Search lets you program and search 10 custom search ranges. You can search any of these ranges simultaneously and select each custom search range you set. During custom search, the scanner searches starting

### Searching and Storing

---

---

with the lowest frequency in the search range you select to the highest frequency in the range.

Notes:

- Search ranges are preset. See “Editing a Custom Search Range” on Page 82 to change the range.
  - You cannot turn off all custom search ranges.
1. Press **Menu** then turn the scroll control until *SEARCH FOR ...* appears. Then press **E**. Or, press **Func** + **Scan/Srch**, then select **No**. One of the search feature options appear.
  2. Turn the scroll control until *CUSTOM SEARCH* appears, then press **E** to select it. The scanner starts custom search of the custom search range you selected, stopping on any transmission it finds and displaying the frequency. Turn the scroll control to change the search direction. An arrow appears, showing the current search direction.

To turn search ranges on or off, press **0** and **1-9**.

To hold searching, press **Hold**. To resume searching, press **Func** then press **Scan/Srch** or **Hold** again.

To lock out a frequency found while searching, press **L/O**. *SEARCH LOCKOUT?* appears. Press **E** to lock out the frequency or **No** to continue monitoring.

If you turn off the active custom search range, the scanner skips to the next custom search range and continues searching.

Note: If all frequencies in all active custom search ranges are locked out, *ALL LOCKED!* appears and the scanner does not stop.

## ***Editing a Custom Search Range***

You can edit up to 10 custom search ranges. The names of the custom search ranges appear on the display. The default custom search range names appear as *CUSTOM 1*, *CUSTOM 2*, and so on.

## **Searching and Storing**

- 
- 
1. Press **Menu** then turn the scroll control until *SEARCH FOR ...* appears. Then press **E**. Or press **Func** and **Srch**, then **No**. One of the search feature options appear.
  2. Turn the scroll control until *EDIT CUSTOM* appears, then press **E** to select it.
  3. Turn the scroll control until the name of the custom search range you want to edit appears, then press **E** to select it. The following options appear as you turn the scroll control.

*EDIT NAME* - lets you edit the custom search range's name

*EDIT SRCH LIMIT* - lets you view and select the frequency ranges to search. The scanner prompts you to enter the upper and lower search limits.

*SET DELAY TIME* - lets you set the amount of time the scanner will delay before continuing to search after a transmission ends

*SET MODULATION* - lets you set the custom search range's modulation type

*SET ATTENUATOR* - lets you set whether the scanner will attenuate reception by 18dB during search

*SET DATA SKIP* - lets you set whether the scanner will skip data transmissions during search

*SET STEP* - lets you set the custom search range's step (the gap between frequencies)

4. Select the option you want to change for the custom search range you selected, then press **E**.

## Auto Search and Store

Your scanner's Auto Store feature lets you search for new frequencies in custom search ranges or within a service search range on a conventional system, or new talk group ID's on a trunked system.

---

---

## Selecting a System

To store frequencies or talk group ID's you find during Auto Store, you must first select a system where the frequencies or talk group ID's will be stored.

1. Press **Menu** then turn the scroll control until *SEARCH FOR ...* appears. Then press **E**. One of the search feature options appear.
2. Turn the scroll control until *SEARCH AND STORE* appears, then press **E** to select it.
3. Turn the scroll control until the system where you want to store the frequencies or talk group ID's appears, then press **E** to select it.

If no systems are programmed, or all systems are locked out, *NO SYSTEM STORED* appears.

## Storing a Conventional System

You can store frequencies into the system you selected in "Selecting a System". Otherwise, the scanner stores frequencies in a new group it creates.

1. Follow Steps 1-3 under "Selecting a System". A search option appears.
2. Turn the scroll control until the type of search you want appears, then press **E** to select it. A search band appears.

If all systems are locked out, *ALL LOCKED!* appears and the scanner does not store any frequencies.

When you select a search range, the scanner looks for active frequencies within that range and *SEARCH AND STORE* appears on the display's lower line and the system name and search range name appear on the display's upper line. When the scanner finds an active transmission, it checks to see if the frequency has already been stored in the system. If the frequency has already been stored, the scanner continues to search. If the frequency has not been stored, it stores the frequency into a group named *FOUND CHANNELS*, then resumes

## Searching and Storing

---

---

searching. The scanner creates this group if it does not already exist.

## ***Storing a Trunked System***

You can store talk group ID's into the system you selected in "Selecting a System". Otherwise, the scanner stores talk group ID's in a new group it creates.

Note: Trunked system search and store does not work if an EDACS SCAT system is selected, a system with no frequency is selected, the selected system is locked out or the quick key for system to which the system belongs is turned off, and the group you selected to store found talk group ID's contains more talk group ID's than the maximum set in Max Auto Store.

1. Follow Steps 1-3 under "Selecting a System". A search option appears.
2. Turn the scroll control until the type of search you want appears, then press **E** to select it. A search band appears.

If all systems are locked out, *ALL LOCKED!* appears and the scanner does not store any frequencies.

When you select a search range, the scanner looks for active talk group ID's within that range and *ID SEARCH AND STORE* appears on the display's lower line and the system name and search range name appear on the display's upper line. When the scanner finds an active talk group ID, it checks to see if the talk group ID has already been stored in the system. If the talk group ID has already been stored, the scanner continues to search. If the talk group ID has not been stored, it stores the talk group ID into a group named *FOUND CHANNELS*, then resumes searching. The scanner creates this group if it does not already exist.

---



---

# Using the Close Call Feature

---

---

Your scanner's Close Call™ feature lets you set the scanner so it detects, displays the frequency of, and lets you hear a nearby strong radio transmission. You can set the scanner so the Close Call feature works "in the background" while you are scanning other frequencies, turn off normal scanning while the Close Call feature is working, or turn off the Close Call feature and use the scanner normally. You can set the scanner so it alerts you when the Close Call feature finds a frequency. You can also set the frequency band where you want the scanner to look for transmissions.

To turn Close Call detection on or off, press **[Func]** then . When the feature is on,  appears on the display and normal operation is briefly interrupted about every 2 seconds.

## Notes:

- The Close Call feature works well for locating the source of strong local transmissions such as mobile and handheld two-way radios in areas with no other strong transmission sources. Several factors affect Close Call performance, however. Performance is increased with higher transmit power, receive antenna tuned to the target band, and a low background RF level. Other than the antenna, you have no control over these factors, but they explain why performance might vary by both location and time.
- The Close Call feature cannot detect satellite dishes or any transmitter with a frequency above or below the frequency ranges listed under "Setting Close Call Options" on Page 87.
- The Close Call feature works better with some types of transmissions than others. It might not correctly display frequency information for transmitters using a highly directional antenna (such as an amateur radio beam antenna) or if there are many transmitters operating at the same time in the same area.

---

---

## Setting Close Call Options

1. Press **Menu** then turn the scroll control until *CLOSE CALL* appears. Then press **E**. Close Call feature options appear.
2. Turn the scroll control to select an option.

- *CLOSE CALL ONLY*: Lets you set the scanner only for Close Call searching. The scanner does not scan frequencies or channels when this option is turned on. To select this option, press **E**.

- *SET CC BANDS*: Lets you select the Close Call band settings. You can turn the following bands on or off.

*VHF LOW* (25.0000 - 54.0000 MHz)

*AIR BAND* (108.0000 - 136.9750 MHz)

*VHF HIGH* (137.0000 - 224.9950 MHz)

*UHF* (400.0000 - 512.0000 MHz)

*800MHZ+* (806.0000 - 956.0000 MHz)

Use the scroll control to select a band, press **E**, then use the scroll control to select *ON* or *OFF* and press **E**. Turning off undesired bands speeds up Close Call operation. (The Close Call feature does not work for frequencies greater than 956 MHz.)

- *SET CC ALERT*: Lets you select how the scanner alerts you when it receives a Close Call signal. You can select any of the following options.

*BEEP+LIGHT* (the scanner beeps and the backlight turns on when it receives a Close Call signal)

*LIGHT* (the backlight turns on when it receives a Close Call signal)

*BEEP* (the scanner beeps when it receives a Close Call signal)

*NONE* (the scanner does not alert)

Turn the scroll control to display an option, then press **E**.

- *SET CC OVERRIDE*: Lets you select how the Close Call feature works with other scanning activities. If you turn this option off, when the scanner detects a Close Call signal, *CC FOUND!* and *E TO LISTEN*

## Using the Close Call Feature

---

---

appear for about 3 seconds. Press **E** when this appears to jump to and hold on the frequency.

If this option is turned on, the scanner overrides the current channel and goes to the Close Call hit. The scanner displays *CC FOUND! PRESS ANY KEY.* When you press a key, the frequency is displayed.

Turn the scroll control to display an option, then press **E**.

- *SET CC MODE:* Lets you select the Close Call mode. If you turn this option on, the scanner sets itself to its Close Call settings about once every 2 seconds.

Turn the scroll control to display an option, then press **E**.

You can also toggle this setting by pressing **[Func]** then .

- *CC AUTOSTORE:* Lets you select whether the scanner automatically stores Close Call hits into channels. If you turn this option on, the scanner starts Close Call mode and stores any Close Call hits, up to the maximum you specified in the Max Auto Store setting. If the scanner stores more hits this setting, it stops Autostore operation.

Turn the scroll control to display an option, then press **E**.

## Close Call Hits

When the scanner detects a Close Call hit, it alerts you according to the Override and Alert settings in the previous section. While listening to a Close Call hit, you can press **Hold** to hold on the hit frequency, press **E** to quickly save the frequency into memory, press **L/O** to lock out the frequency from Close Call and Search operation, or wait for the transmission to end. If you are in Close Call Only or Close Call Override mode, and you do not press any key, the scanner returns to its previous operation after the transmission ends and the set delay time expires.

If you are holding on the frequency, press **Hold** again to resume the previous operation.

## Using the Close Call Feature



---

---

# Search and Close Call Options

---

---

The settings in this section affect custom searches, service searches, and Close Call operation.

## Managing Locked-Out Frequencies

While searching or during Close Call operation, if you press **L/O** while the scanner is stopped on a frequency, that frequency is locked out of these modes. You can lock out up to 200 frequencies.

Note: Locking out a frequency does not lock out a channel that contains that frequency.

### Unlocking All Frequencies

**Menu** → ↻ SRCH/CLOCALL OPT → **E** ↻  
FREQ LOCKOUTS → **E** → UNLOCK ALL → **E**

The scanner prompts you to confirm deletion. To confirm and delete all locked-out frequencies, press **E**. Otherwise, to cancel, press **No**.

### Reviewing Locked Out Frequencies

**Menu** → ↻ SRCH/CLOCALL OPT → **E** ↻  
FREQ LOCKOUTS → **E** → RVW SEARCH L/O → **E**

The scanner displays the first locked-out frequency and prompts you to unlock the frequency. Press **E** to unlock the frequency. Or, rotate the scroll control or press **No** to select a different frequency. To exit the review, press

**Menu** .

## Searching for Subaudible Tones

**MENU** → ↻ SRCH/CLOCALL OPT → **E** ↻  
CTCSS/DCS SEARCH → **E**

This setting controls whether the scanner will search for a subaudible tone when it stops on a transmission during search or Close Call operation.

**OFF** The scanner does not search for subaudible tones.

**ON** The scanner searches for and displays any subaudible tone found.

## Search and Close Call Options

---

---

Note: This feature does not operate when the scanner is in AM modulation mode.

## Screening Out Paging Systems

**Menu** →  *SRCH/CLOCALL OPT* → **E**   
*PAGER SCREEN* → **E**

This setting determines whether the scanner automatically ignores transmissions found during searching or Close Call operation that are on common paging system frequencies.

*ON* The scanner skips known paging system frequencies.

*OFF* The scanner stops on any detected transmission, including paging systems.

Notes:

- The default setting for this feature is *ON*.
- The frequencies include paging systems and also the NOAA weather frequencies.
- Even with the feature on, you might hear some paging systems. Some frequencies are shared between business radio systems and paging systems. If the scanner stops on a paging system even with this feature turned on, manually lock it out by pressing **L/O**.

## Finding Repeater Output Frequencies

**Menu** →  *SRCH/CLOCALL OPT* → **E**   
*REPEATER FIND* → **E**

This feature sets whether the scanner tries to tune to a repeater output frequency during Close Call operation when it detects a transmission on a repeater input frequency. Since you can normally only hear one side of a conversation when you listen to an input frequency transmission, turning this feature on can let you hear both sides of the conversation.

## Search and Close Call Options

---

---

**ON** The scanner automatically applies repeater reverse to detected transmissions. If the scanner detects the transmission on the output frequency, it beeps, *REPEATER FIND* appears, and it remains on the output frequency until transmissions end. If it does not detect a transmission on the output frequency, it remains on the original frequency.

**OFF** The scanner does not try to find the output frequency.

## Setting the Maximum Auto Store Value

**Menu** → ↻ *SRCH/CLOCALL OPT* → **E** ↻  
*MAX AUTO STORE* → **E**

This value sets how many hits the scanner will automatically store when it is in either Search and Store or Close Call Auto Store mode.

Use the number keys to enter a value from 1 - 256, then press **E**.

When the scanner reaches the maximum number of hits you set, it stops the auto-store operation.

## Setting the Modulation Type

**Menu** → ↻ *SRCH/CLOCALL OPT* → **E** ↻  
*SET MODULATION* → **E**

This setting controls the modulation type used for quick search and Close Call operations. Select your setting, then press **E**.

**AUTO** Uses the default setting for the current frequency (see the table at the front of the manual)

**AM** Uses AM (amplitude modulation)

**FM** Uses FM (frequency modulation)

**NFM** Uses narrowband FM

---

---

## Setting Attenuation

**Menu** → ↻ SRCH/CLOCALL OPT → **E** ↻  
SET ATTENUATION → **E**

This setting controls the attenuator for quick search and Close Call operation. Select your setting, then press **E**.

*OFF* The attenuator is off.

*ON* Reception is attenuated by about 18 dB.

Note: Turn on this setting if you are near other strong signal sources. Attenuation sometimes helps to reduce interference and desensitization that strong signals create.

## Setting Data Skip

**Menu** → ↻ SRCH/CLOCALL OPT → **E** ↻  
SET DATA SKIP → **E**

This setting controls how the scanner behaves when it detects a constant-level transmission during quick search or Close Call operation. Select your setting, then press **E**.

*OFF* The scanner remains on the transmission until it ends.

*ON* The scanner quickly resumes searching or Close Call operation.

Notes:

- If you are trying to test the Close Call feature with a nearby transmitter and you do not talk into the transmitter, the scanner will detect this as data and will skip the frequency when Data Skip is on. Turn the feature off or talk into the transmitter.
- The default for this feature is *ON*.

---

---

## Setting the Delay Time

**Menu** → ↻ SRCH/CLOCALL OPT → **E** ↻  
SET DELAY TIME → **E**

This setting determines how long the scanner waits after a transmission ends before resuming quick search or Close Call operation. Select your setting, then press **E**.

*OFF* The scanner resumes immediately when the transmission ends.

*1-5 SEC* The scanner waits the set amount of time after the transmission ends before resuming.

Note: The default setting is 2 seconds.

## Setting the Search Frequency Step

**Menu** → ↻ SRCH/CLOCALL OPT → **E** ↻  
SET STEP → **E**

This setting selects the frequency step used for setting the channels. Select your setting, then press **E**.

*AUTO* The step is based on the band (see the table at the front of the manual)

*5.0 KHZ, 6.25 KHZ, 7.5 KHZ, 10.0 KHZ, 12.5 KHZ, 15.0 KHZ,  
20.0 KHZ, 25.0 KHZ, 50.0 KHZ, 100.0 KHZ* The scanner  
uses the selected step.

Note: The scanner defaults to *AUTO*.

---

---

## Using Weather Alert (SAME)

---

---

Your scanner has been primarily designed to be a radio scanner. While it incorporates weather alert as one of its features, we strongly recommend that you not use the scanner as your sole means for receiving emergency alerts. Your local electronics retailer carries several weather radios specifically designed for this function.

Your scanner allows you to search for a local NOAA weather broadcast and set it to alert when a SAME weather alert is broadcast on a NOAA channel. You can also program SAME codes into the scanner and set a weather channel as a priority channel.

In the following sections, you can also access the weather menu from Hold mode by holding **[Func]** then pressing **Wx**.

### Searching For a Weather Broadcast

**[Menu]** →  *LWX OPERATION* → **E** →  
*WEATHER SCAN* → **E**

The scanner starts scanning the preprogrammed weather frequencies, and stops on the first signal. If this station is weak, rotate the scroll control to check for other weather broadcasts in your area.

**Note:** NOAA broadcasts are continuous broadcasts. You will only lose reception if you move out of a coverage area. If the signal is lost, the scanner resumes searching for a weather transmission.

### Turning Weather Alert On/Off

In weather alert mode, your scanner functions as a severe weather warning radio. This is especially useful when your area is expecting severe weather conditions late at night. When you set the scanner to weather alert mode, it holds on the weather channel, but does not play the channel's audio. If it detects a weather alert, it sounds a tone, displays information about the weather alert, and turns on the audio so you can hear the weather broadcast.

## Using Weather Alert (SAME)

---

---

**Menu** → ↻ *WX OPERATION* → **E** ↻  
*WEATHER ALERT* → ↻

This setting determines which types of signals will trigger an alert. Select your setting, then press **E**.

*ALERT ONLY* - the scanner alerts when it detects the 1050 Hz tone that accompanies all weather alerts.

*ALL FIPS* - the scanner alerts and displays information about the weather alert when it receives any FIPS code (see “Programming a SAME Group” on Page 95).

*SAME 1-5* - the scanner alerts and displays information about the weather alert when it receives a weather alert signal that includes any FIPS code you have programmed into the specified SAME group.

## Programming a SAME Group

You can edit any of the 5 SAME groups in your scanner. Each group can have up to 8 FIPS codes.

SAME (Specific Area Messaging System) is a system developed by the National Weather Service to reduce the number of alerts received by consumers by allowing them to hear alerts only for the county(ies) they are interested in. Each alert contains information about the type and severity of the alert, as well as the specific geographic locations affected by the alert.

The geographic locations are designated using FIPS codes. Each county or parish in the US and its territories are assigned a FIPS code. In addition, certain special regions and wildcard settings can be assigned.

FIPS codes are in the format nSSCCC:

n: A special subcounty designator. For an entire county, use 0.

SS: The state code.

CCC: The county code.

## Using Weather Alert (SAME)

---

---

For example, Tarrant County in Texas is assigned to FIPS code 048439.

0 indicates the entire county

48 indicates the state of Texas

439 indicates Tarrant County

To get the FIPS code for your county, visit the National Weather Service web site at <http://www.nws.noaa.gov> and search for "FIPS Listing".

**Menu** → ↻ *WX OPERATION* → **E** ↻  
*PROGRAM SAME* → **E** ↻ *SELECT SAME* →  
↻ select the SAME group to edit → **E** → ↻

Select the setting to change, then press **E**.

*EDIT NAME* - enter the name you want to assign to the SAME group you selected (see "Entering Text" on Page 17).

*EDIT COUNTY* - select the position you want to store the FIPS code into, then press **E**, enter the FIPS code, and press **E** again.

## Setting WX Alert Priority

**Menu** → ↻ *WX OPERATION* → **E** ↻  
*WX ALT PRIORITY* → **E** → ↻

*ON* - the scanner checks the weather channels every 5 seconds for a 1050 Hz weather alert signal. Press **E** to select.

*OFF* - the scanner does not check the weather channels. Press **E** to select.

## Using Weather Alert (SAME)



---

---

# Care and Maintenance

---

---

## General Use

- Turn the scanner off before disconnecting the power.
- Always write down the programmed frequencies in the event of memory loss.
- If memory is lost, simply reprogram each channel.
- Always press each button firmly until you hear the entry tone for that key entry.

## Location

- Do not use the scanner in high-moisture environments such as the kitchen or bathroom.
- Avoid placing the unit in direct sunlight or near heating elements or vents.
- If the scanner receives strong interference or electrical noise, move it or its antenna away from the source of the noise. If possible, a higher elevation might provide better reception.
- Also try changing the height or angle of the antenna.

## Cleaning

- Disconnect the power to the unit before cleaning.
- Clean the outside of the scanner with a mild detergent.
- To prevent scratches, do not use abrasive cleaners or solvents. Be careful not to rub the LCD window.
- Do not use excessive amounts of water.

---

---

## Repairs

Do not attempt any repair. The scanner contains no user serviceable parts. Contact the Uniden Customer Service Center or take it to a qualified repair technician.

## Birdies

All radios can receive “birdies” (undesired signals). If your scanner stops during Scan mode and no sound is heard, it might be receiving a birdie. Birdies are internally generated signals inherent in the electronics of the scanner.

Press **L/O** to lock out the channel.

# Troubleshooting

If your BC246T is not performing properly, try these steps.

| Problem                   | Possible Cause   | Suggestion  |
|---------------------------|--|---|
| The scanner doesn't work. | The scanner might not be receiving any power.          | Make sure the AC adapter is connected to an AC outlet and the scanner.  |
|                           |  | If there is a wall switch that controls power to the AC outlet where you connected the AC adapter, make sure it is on.              |
| Improper reception.       | The antenna might need to be adjusted.                 | Check the antenna connection or move or reposition the antenna.   |
|                           |  | Move the scanner.   |
|                           |  | You might be in a remote area that could require an optional multi-band antenna. Check with your dealer or local electronics store. |
| Scan won't stop.          | The squelch might need to be adjusted.                 | Adjust the squelch threshold. See "Turning On the Scanner and Setting the Squelch" on Page 41.                                      |
|                           | The antenna might need to be adjusted.                 | Check the antenna connection.   |
|                           | One or more channels might be locked out.              | Make sure the channels you want to scan are not locked out.   |
|                           | The channel's frequency might not be stored in memory. | Make sure the channel's frequency is stored in the scanner's memory.  |
|                           | The channel might not be active.                       | Wait for a transmission on the channel.   |
| Scan won't start.         | You must press <b>Scan</b> to scan.                    | Press <b>Scan</b> .   |
|                           | The squelch might need to be adjusted.                 | Adjust the squelch threshold. See "Turning On the Scanner and Setting the Squelch" on Page 41.                                      |

## Troubleshooting

|  |   |  |
|--|---|--|
| Scan won't start<br><i>(continued)</i> | One or more channels might be locked out.                 | Make sure the channels you want to scan are not locked out.                                    |
|  | The antenna might need to be adjusted.                    | Check the antenna connection.  |
| Weather scan doesn't work.             | The squelch might need to be adjusted.                    | Adjust the squelch threshold. See "Turning On the Scanner and Setting the Squelch" on Page 41. |
|  | The antenna might need to be adjusted.                    | Check the antenna connection.  |
|  | There might not be a NOAA weather broadcast in your area. | Move to an area with a NOAA weather broadcast.   |

If you experience difficulty while in TrunkTracker™ mode, try the following steps.

| <b>Problem</b>                        | <b>Possible Cause</b>   | <b>Suggestion</b>   |
|---------------------------------------|---|---|
| Scanner won't track a trunked system. | The system might not be one your scanner can scan.              | Scan another system.  |
|                                       | The data frequency might be missing.                            | Enter the data frequency.   |
|                                       | The scanner might need to be changed to a Type 1 scanner setup. | Change to a Type 1 scanner setup. Review "Programming Motorola Systems" on Page 54.   |
|                                       | The system you are trying to scan might be LTR or EDACS.        | Set the scanner to scan LTR or EDACS systems. Review "Programming LTR Systems" on Page 60 and "Programming EDACS Systems" on Page 58. |

## Troubleshooting

|   |   |   |
|---|---|---|
| Scanner won't stop scanning a trunked system. | No ID's have been programmed.                                   | Program one or more ID's or use the ID Search mode.   |
|   | The ID's you have stored are not active.                        | Wait for the ID's to become active or scan another system.  |
| Scanner won't acquire the data channel.       | The squelch might need to be adjusted.                          | Adjust the squelch threshold. See "Turning On the Scanner and Setting the Squelch" on Page 41.  |
|   | The frequency used for the data channel might be missing.       | Check your frequency list for the data channel.   |
| Missing replies to conversations.             | The scanner might need to be changed to a Type 1 scanner setup. | Change to a Type 1 scanner setup. See "Programming Motorola Systems" on Page 54.  |
|   | The fleet map might be incorrect.                               | Try another preset fleet map or program your own fleet map.   |
|   | One or more of the system's frequencies might not be entered.   | Make sure all the system's frequencies have been entered.   |
|   | The system you are trying to scan might be LTR or EDACS.        | Set the scanner to scan LTR or EDACS systems. Review "Programming LTR Systems" on Page 60 and "Programming EDACS Systems" on Page 58. |

If you still cannot get satisfactory results while using your scanner or if you want additional information, please call or write the Uniden Parts and Service Division. The address and phone number are listed in the Warranty at the end of this manual. If you would like immediate assistance, please call Customer Service at (800) 297-1023.

If you have Internet access, you can visit <http://www.uniden.com> for additional information.

## Troubleshooting

---

---

# Specifications

---

---

Certified in accordance with FCC Rules and Regulations Part 15, Subpart C, as of date of manufacture.

## Dynamic Allocation Capacity

(with Name Assigned To Each System, Group, and Channel):

Systems: ..... 200 max  
Groups: ..... 20 per system  
Channels: ..... up to 2500  
Channels per Trunked System: ..... up to 200

Attenuation: ..... 18 dB (nominal), 10 dB (limit)

## Frequency Range (MHz):

25.0 - 26.960 ..... Petroleum Prods/Bcst Pinchup Band  
26.965 - 27.405 ..... Citizens Band Class D  
27.410 - 27.995 ..... Business/Forest Prods  
137.0 - 143.995 ..... Military Band  
144.0 - 147.995 ..... 2 Meter Amateur Band  
148.0 - 161.995 ..... VHF High Band  
216.0 - 224.995 ..... 1.25 Meter Amateur Band

## Above bands in 5 kHz steps

28.0 - 29.690 ..... 10 Meter Amateur Band  
29.7 - 49.990 ..... VHF Low Band  
50.0 - 54.0 ..... 6 Meter Amateur Band

## Above bands in 10 kHz steps

162.0 - 174.0 ..... Federal Government  
400.0 - 405.9875 ..... Miscellaneous  
406.0 - 419.9875 ..... Federal Land Mobile  
420.0 - 449.9875 ..... 70 cm Amateur Band  
450.0 - 469.9875 ..... UHF Standard Band  
470.0 - 512.0 ..... UHF TV Band  
806.0 - 823.9875 ..... Public Service Band  
849.0125 - 868.9875 ..... Public Service Band  
894.0125 - 956.0 ..... Public Service Band  
1240.0 - 1300.0 ..... 25 cm Amateur Band

## Above bands in 12.5 kHz steps

108.0 - 136.9750 ..... Aircraft

## Above band in 25 kHz steps

## Operating Temperature:

Normal ..... -20°C to +60°C  
Close Call ..... -10°C to +60°C

## Specifications

---

---

Scan Rate: ..... 100 channels per second  
(conventional mode)

Search Rate: ..... 300 steps per second (5 kHz step only)

Scan Delay: ..... 0-5 seconds

Audio Output: .. 320mW nominal into 8 $\Omega$  internal speaker  
30 mW nominal into 32 $\Omega$  headphone  
6 mW nominal into 64 $\Omega$  earphone

Power Requirements:

2 AA Alkaline Batteries (3V DC),  
or 2 AA Rechargeable Ni-MH Batteries (2.4V DC),  
or AC Adapter (6 VDC 500mA) (AD-0008)

Antenna: ..... 50  $\Omega$  (Impedance)

External Jacks:

Antenna Jack ..... BNC Type

Ext. Speaker Jack ..... 3.5mm

DC Power Jack (EIAJ TYPE-2 Center Positive) 5.5mm

Remote Jack ..... 4 Pin Mini

Size: ..... 2.72 in. (W) x 1.26 in. (D) x 4.6 in. (H)

Weight: ..... 0.48 lbs

Features, specifications, and availability of optional accessories are all subject to change without notice.

## Specifications

---

---

## Optional Accessories

---

---

Contact your local Uniden Dealer or call the Uniden Parts Center at: (800) 554-3988, 8:00AM to 5:00PM EST, Monday through Friday, for information about ordering these optional accessories.

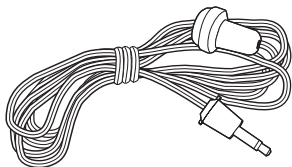

Earphone

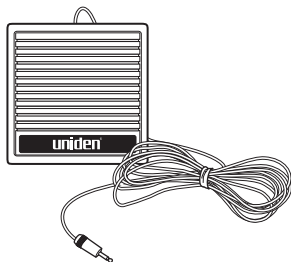

External Amplified Speaker



Betty Bearcat Frequency Directory/  
Local Directories



# Appendix

## Preset Fleet Maps

Preset Map 1

| Block | Size Code    |
|-------|--------------|
| 0     | Size Code 11 |
| 1     | Size Code 11 |
| 2     | Size Code 11 |
| 3     | Size Code 11 |
| 4     | Size Code 11 |
| 5     | Size Code 11 |
| 6     | Size Code 11 |
| 7     | Size Code 11 |

Preset Map 2

| Block | Size Code   |
|-------|-------------|
| 0     | Size Code 4 |
| 1     | Size Code 4 |
| 2     | Size Code 4 |
| 3     | Size Code 4 |
| 4     | Size Code 4 |
| 5     | Size Code 4 |
| 6     | Size Code 4 |
| 7     | Size Code 4 |

Preset Map 3

| Block | Size Code      |
|-------|----------------|
| 0     | Size Code 4    |
| 1     | Size Code 4    |
| 2     | Size Code 4    |
| 3     | Size Code 4    |
| 4     | Size Code 4    |
| 5     | Size Code 4    |
| 6     | Size Code 12   |
| 7     | (Size Code 12) |

Preset Map 4

| Block | Size Code      |
|-------|----------------|
| 0     | Size Code 12   |
| 1     | (Size Code 12) |
| 2     | Size Code 4    |
| 3     | Size Code 4    |
| 4     | Size Code 4    |
| 5     | Size Code 4    |
| 6     | Size Code 4    |
| 7     | Size Code 4    |

Preset Map 5

| Block | Size Code      |
|-------|----------------|
| 0     | Size Code 4    |
| 1     | Size Code 4    |
| 2     | Size Code 12   |
| 3     | (Size Code 12) |
| 4     | Size Code 4    |
| 5     | Size Code 4    |
| 6     | Size Code 4    |
| 7     | Size Code 4    |

Preset Map 6

| Block | Size Code      |
|-------|----------------|
| 0     | Size Code 3    |
| 1     | Size Code 10   |
| 2     | Size Code 4    |
| 3     | Size Code 4    |
| 4     | Size Code 12   |
| 5     | (Size Code 12) |
| 6     | Size Code 12   |
| 7     | (Size Code 12) |

Preset Map 7

| Block | Size Code    |
|-------|--------------|
| 0     | Size Code 10 |
| 1     | Size Code 10 |
| 2     | Size Code 11 |
| 3     | Size Code 4  |
| 4     | Size Code 4  |
| 5     | Size Code 4  |
| 6     | Size Code 4  |
| 7     | Size Code 4  |

Preset Map 8

| Block | Size Code   |
|-------|-------------|
| 0     | Size Code 1 |
| 1     | Size Code 1 |
| 2     | Size Code 2 |
| 3     | Size Code 2 |
| 4     | Size Code 3 |
| 5     | Size Code 3 |
| 6     | Size Code 4 |
| 7     | Size Code 4 |

Preset Map 9

| Block | Size Code   |
|-------|-------------|
| 0     | Size Code 4 |
| 1     | Size Code 4 |
| 2     | Size Code 0 |
| 3     | Size Code 0 |
| 4     | Size Code 0 |
| 5     | Size Code 0 |
| 6     | Size Code 0 |
| 7     | Size Code 0 |

Preset Map 10

| Block | Size Code   |
|-------|-------------|
| 0     | Size Code 0 |
| 1     | Size Code 0 |
| 2     | Size Code 0 |
| 3     | Size Code 0 |
| 4     | Size Code 0 |
| 5     | Size Code 0 |
| 6     | Size Code 4 |
| 7     | Size Code 4 |

Preset Map 11

| Block | Size Code   |
|-------|-------------|
| 0     | Size Code 4 |
| 1     | Size Code 0 |
| 2     | Size Code 0 |
| 3     | Size Code 0 |
| 4     | Size Code 0 |
| 5     | Size Code 0 |
| 6     | Size Code 0 |
| 7     | Size Code 0 |

Preset Map 12

| Block | Size Code   |
|-------|-------------|
| 0     | Size Code 0 |
| 1     | Size Code 0 |
| 2     | Size Code 0 |
| 3     | Size Code 0 |
| 4     | Size Code 0 |
| 5     | Size Code 0 |
| 6     | Size Code 0 |
| 7     | Size Code 4 |

Preset Map 13

| Block | Size Code    |
|-------|--------------|
| 0     | Size Code 3  |
| 1     | Size Code 3  |
| 2     | Size Code 11 |
| 3     | Size Code 4  |
| 4     | Size Code 4  |
| 5     | Size Code 0  |
| 6     | Size Code 0  |
| 7     | Size Code 0  |

Preset Map 14

| Block | Size Code      |
|-------|----------------|
| 0     | Size Code 4    |
| 1     | Size Code 3    |
| 2     | Size Code 10   |
| 3     | Size Code 4    |
| 4     | Size Code 4    |
| 5     | Size Code 4    |
| 6     | Size Code 12   |
| 7     | (Size Code 12) |

Preset Map 15

| Block | Size Code      |
|-------|----------------|
| 0     | Size Code 4    |
| 1     | Size Code 4    |
| 2     | Size Code 4    |
| 3     | Size Code 11   |
| 4     | Size Code 11   |
| 5     | Size Code 0    |
| 6     | Size Code 12   |
| 7     | (Size Code 12) |

Preset Map 16

| Block | Size Code      |
|-------|----------------|
| 0     | Size Code 3    |
| 1     | Size Code 10   |
| 2     | Size Code 10   |
| 3     | Size Code 11   |
| 4     | Size Code 0    |
| 5     | Size Code 0    |
| 6     | Size Code 12   |
| 7     | (Size Code 12) |

---

---

## User Defined Fleet Maps

### *Type I Programming Information*

When a Type I system is designed, the address information for all the ID's is divided into 8 equal sized blocks, numbered 0–7. When you program your scanner to track a Type I system, you must select a size code for each of these blocks. When you have assigned a size code to all 8 blocks, you'll have defined the fleet map for the system you are tracking. Each size code determines the number of fleets, subfleets, and ID's each block will have. For example, a size code of S-4 has one fleet, which is divided into 16 separate subfleets, and it has a total of 512 individual ID's.

When a block is assigned a size code, the fleet or fleets created within the block are assigned a Type I ID. The way these ID's display on your scanner depend on the block number and the block's size code. When a Type I ID appears, the leftmost digit represents the block which contains the ID.

The next 2-3 digits identify which fleet is active, and the last digit(s) identifies the subfleet.

The details concerning how the size codes are selected by a Type I System designer are highly dependent on the specific needs of the system's users. Some organizations might want many subfleets with only a few radios each, while another organization might want only a few subfleets with many radios each. Your task is to program your fleet map with the same size code assignments as the trunked system. If you do this accurately, you'll track all the Fleet-Subfleet combinations used by the system. In other words, you'll hear complete communications while monitoring a trunked system.

If you don't already know the size codes used, you'll have to guess at them. But since you don't have to figure out all the blocks at once, this isn't as hard as it seems. Select a size code for a block, and then press **Scan**. Now listen to the communications. If you decide you are receiving most of the replies to the conversations with ID's assigned to

---

---

the block you just programmed, then you've probably selected the right size code and can work on the next block of the map.

Finally, for most public safety systems there are some size codes which are more common. S-3 and S-4 are probably the most common, followed by S-10, S-11, and S-12.

### ***Size Code Restrictions***

If you select size code S-12, S-13, or S-14, there are some restrictions as to which blocks can be used for these codes.

S-12 can only be assigned to Blocks 0, 2, 4, or 6.

S-13 can only be assigned to Blocks 0 and 4.

S-14 can only be assigned to Block 0.

Since these size codes require multiple blocks, you will be prompted for the next available block when programming a fleet map. For example, if you assign Block 0 as an S-12, you will be prompted for b2, the next block available, instead of b1. And if you assign Block 0 as an S-14, you would not see another prompt because it uses all available blocks.

---

---

# Planning

---

---

## Collecting Information

Getting your scanner programmed and scanning takes a few steps. This help guides you through these steps that will make it easier for you to start scanning.

1. Collect information about the system(s) you want to monitor.

Do you want to listen to your local police and fire departments? How about the highway patrol, ambulance service, and aircraft? You might even want to listen to your local utility company as they track down a break in electrical service in your area.

Make a list of the agencies you want to listen to, then look up the frequencies and systems used by those agencies. The Internet is a great source for current frequencies and information about scanning. Here are a few useful sites:

- <http://www.scannermaster.com/> - frequency resources and home of Police Call.

You can also call them at 1 800 SCANNER (hours are from 10:00 a.m. to 5:00 p.m. Eastern Time Monday through Friday.)

- <http://www.radioreference.com/> - the Internet's premier source for user-supported radio system information.
- <http://www.bearcat1.com/> - frequency information from National Communications.
- <http://svartifoss2.fcc.gov/reports/index.cfm> - conventional frequency information on file with the US Government

### Tips:

- Scanners are designed to monitor complex radio systems. That means that programming your scanner might seem like a daunting task at first. Be patient if you don't get it right the first time. You can also seek out help locally for the systems you want to scan by visiting the forums section of <http://www.radioreference.com/forums>.
- Before you start to program your scanner, decide how you want to organize the frequencies you want to scan. For example, some areas are best organized by

**Planning**

- 
- 
- geographic location (east, north, south, west, central, etc), while others are best organized by agency (police, sheriff, ambulance, fire, etc.). You might even find it easier to organize a mixture of frequencies (north, southeast, and west for police but fire all in one group for example).
2. Organize the system information using these system worksheets included in this appendix.
    - Use "Conventional System Worksheet" on Page 114 to organize info about conventional frequencies.
    - Use "Motorola System Worksheet" on Page 115 to organize information about Motorola frequencies.
    - Use "LTR/EDACS System Worksheet" on Page 117 to organize information about LTR and EDACS frequencies.
  3. Follow the instructions in "Filling Out The Conventional System Worksheet" on Page 110, "Filling Out The Motorola Worksheet" on Page 111, and "Filling Out the LTR and EDACS Worksheet" on Page 113 to program your scanner.

Tips:

- Before you start, make as many copies of the worksheets as you think you'll need. You can also go to the download section of <http://www.uniden.com/productsupport.cfm> and download the worksheets there.
- All worksheet instructions assume that you have completed the critical Step 1 (collecting the system information). Don't skip this step.
- Use a pencil to fill out the worksheets. This lets you change information if necessary.

## **Filling Out The Conventional System Worksheet**

### ***System Name and Quick Key***

Fill in a name that describes the system you want to create. For example, you can enter "Dallas Police" or "Amateur Radio" here. If you want to store more than one type of frequency, you can enter "Mixed."

---

---

Fill in the key you want to press to quickly activate/deactivate the system. You can assign the same quick key to multiple systems.

### ***Group Name and Quick Key***

Each worksheet documents the settings for one channel group within a system. If you have fewer channels in the group than fits on the page, you can skip a line and enter an additional group of channels (enter the group info in the line you skipped). If you have more channels for the group than will fit on the page, use additional pages.

Fill in the key you want to press with **[Func]** to quickly activate/deactivate the channel group. You can assign the same quick key to multiple groups within a system.

### ***Frequency-Alpha Tag-Priority-CTCSS/DCS***

Fill in the details for each channel you want to store in this channel group.

## **Filling Out The Motorola Worksheet**

### ***System Name and Quick Key***

Fill in a name that describes the system you want to create. For example, you can enter "Dallas Police" or "Amateur Radio" here. If you want to store more than one type of frequency, you can enter "Mixed."

Fill in the key you want to press to quickly activate/deactivate the system. You can assign the same quick key to multiple systems.

### ***System Type***

Circle in the type of Motorola system you are scanning.

- Type 1. A fleet map is supplied for this type of system.
- Type 2 800 MHz Standard. Used for most 800 MHz systems. No fleet map is supplied for this type of system.
- Type 2 800 MHz Splinter. Used for some 800 MHz systems near border areas.
- Type 2 900 MHz. The supplied frequencies are between 935.0125 MHz and 939.9875 MHz. No fleet map is supplied for this type of system.

**Planning**

- 
- 
- Type 2 UHF. The supplied frequencies are between 406 MHz and 512 MHz. No fleet map is supplied for this type of system.
  - Type 2 VHF. The supplied frequencies are between 136 MHz and 174 MHz. No fleet map is supplied for this type of system.

## ***System Frequencies***

Enter the frequencies used by the system. Motorola systems can use up to 28 frequencies. Place an asterisk or other mark next to frequencies identified as data channels.

## ***Fleet Map (Type I or Type I/Type II Hybrid Only)***

Fill in the fleet map used by this agency.

## ***Band Plan (VHF or UHF Only)***

A band plan is required so the scanner can correctly determine the voice channel frequency. Fill in the band plan used by this agency, consisting of:

- Base frequency
- Step frequency
- Channel offset

You can enter up to three band plans.

## ***Group Name and Quick Key***

Each “Motorola System Worksheet 2” documents the settings for one channel group within a system. If you have fewer channels in the group than fits on the page, you can skip a line and enter an additional group of channels (enter the group information in the line you skipped). If you have more channels for the group than will fit on the page, use additional pages.

Fill in the key you want to press with **[Func]** to quickly activate/deactivate the channel group. You can assign the same quick key to multiple groups within a system.



---

---

## ***Talk Group ID-Alpha Tag-Alert***

Fill in the details for each channel you want to store in this channel group.

## **Filling Out the LTR and EDACS Worksheet**

### ***System Name and Quick Key***

Fill in a name that describes the system you want to create. For example, you can enter "Dallas Police" or "Amateur Radio" here. If you want to store more than one type of frequency, you can enter "Mixed."

Fill in the key you want to press to quickly activate/deactivate the system. You can assign the same quick key to multiple systems.

### ***System Frequencies and LCN***

Fill in each system frequency and its associated Logical Channel Number (LCN).

### ***Group Name and Quick Key***

Each "LTR/EDACS System Worksheet 2" documents the settings for one channel group within a system. If you have fewer channels in the group than fits on the page, you can skip a line and enter an additional group of channels (enter the group information in the line you skipped). If you have more channels for the group than will fit on the page, use additional pages.

Fill in the key you want to press with **[Func]** to quickly activate/deactivate the channel group. You can assign the same quick key to multiple groups within a system.

## ***Talk Group ID-Alpha Tag-Alert***

Fill in the details for each channel you want to store in this channel group.



# Motorola System Worksheet

| Motorola System Worksheet 1 |                  |  |  |
|-----------------------------|------------------|--|--|
| System Name                 |                  |  |  |
| System Quick Key            |                  |  |  |
| System Frequencies          | Type I           |  |  |
|                             | Type II 800 MHz: |  |  |
|                             | Standard         |  |  |
|                             | Splinter         |  |  |
|                             | Type II UHF      |  |  |
|                             | Type II VHF      |  |  |
|                             |                  |  |  |
|                             | Fleet Map        |  |  |
|                             | Block 0          |  |  |
|                             | Block 1          |  |  |
|                             | Block 2          |  |  |
|                             | Block 3          |  |  |
|                             | Block 4          |  |  |
|                             | Block 5          |  |  |
|                             | Block 6          |  |  |
|                             | Block 7          |  |  |
|                             | Band Plan A      |  |  |
|                             | Base Frequency   |  |  |
|                             | Step Frequency   |  |  |
|                             | Offset           |  |  |
|                             | Band Plan B      |  |  |
|                             | Base Frequency   |  |  |
|                             | Step Frequency   |  |  |
|                             | Offset           |  |  |
|                             | Band Plan C      |  |  |
|                             | Base Frequency   |  |  |
|                             | Step Frequency   |  |  |
|                             | Offset           |  |  |
|                             |                  |  |  |
|                             |                  |  |  |

**Motorola System Worksheet 2**

| System Name   |           | Group Name      |  |  |
|---------------|-----------|-----------------|--|--|
|               |           | Group Quick Key |  |  |
| Talk Group ID | Alpha Tag | Alert           |  |  |
|               |           |                 |  |  |
|               |           |                 |  |  |
|               |           |                 |  |  |
|               |           |                 |  |  |
|               |           |                 |  |  |
|               |           |                 |  |  |
|               |           |                 |  |  |
|               |           |                 |  |  |
|               |           |                 |  |  |
|               |           |                 |  |  |
|               |           |                 |  |  |
|               |           |                 |  |  |
|               |           |                 |  |  |
|               |           |                 |  |  |
|               |           |                 |  |  |
|               |           |                 |  |  |
|               |           |                 |  |  |
|               |           |                 |  |  |
|               |           |                 |  |  |
|               |           |                 |  |  |
|               |           |                 |  |  |
|               |           |                 |  |  |
|               |           |                 |  |  |
|               |           |                 |  |  |
|               |           |                 |  |  |
|               |           |                 |  |  |
|               |           |                 |  |  |
|               |           |                 |  |  |
|               |           |                 |  |  |
|               |           |                 |  |  |
|               |           |                 |  |  |
|               |           |                 |  |  |

**Planning**

---

---

# LTR/EDACS System Worksheet

| LTR/EDACS System Worksheet 1 |                 |  |  |
|------------------------------|-----------------|--|--|
| System Name                  |                 |  |  |
| System Quick Key             |                 |  |  |
| System Frequency             | Logical Channel |  |  |
|                              |                 |  |  |
|                              |                 |  |  |
|                              |                 |  |  |
|                              |                 |  |  |
|                              |                 |  |  |
|                              |                 |  |  |
|                              |                 |  |  |
|                              |                 |  |  |
|                              |                 |  |  |
|                              |                 |  |  |
|                              |                 |  |  |
|                              |                 |  |  |
|                              |                 |  |  |
|                              |                 |  |  |
|                              |                 |  |  |
|                              |                 |  |  |
|                              |                 |  |  |
|                              |                 |  |  |
|                              |                 |  |  |
|                              |                 |  |  |
|                              |                 |  |  |

## LTR/EDACS System Worksheet 2

| System Name      |           | Group Name      |  |
|------------------|-----------|-----------------|--|
| System Quick Key |           | Group Quick Key |  |
| Talk Group ID    | Alpha Tag | Alert           |  |
|                  |           |                 |  |
|                  |           |                 |  |
|                  |           |                 |  |
|                  |           |                 |  |
|                  |           |                 |  |
|                  |           |                 |  |
|                  |           |                 |  |
|                  |           |                 |  |
|                  |           |                 |  |
|                  |           |                 |  |
|                  |           |                 |  |
|                  |           |                 |  |
|                  |           |                 |  |
|                  |           |                 |  |
|                  |           |                 |  |
|                  |           |                 |  |
|                  |           |                 |  |
|                  |           |                 |  |
|                  |           |                 |  |
|                  |           |                 |  |
|                  |           |                 |  |
|                  |           |                 |  |
|                  |           |                 |  |

---

---

# Preprogrammed Systems

---

---

Your scanner is preprogrammed with over 400 channels covering police, fire, and ambulance operations in the 25 most populated counties in the US. The following list details the preprogrammed information.

By default, all of the preprogrammed systems are unlocked, and your scanner begins to scan them when you turn it on. To speed up scanning, you can lock out systems that are beyond your reception area (typically no more than 25 miles using the supplied antenna).

Follow these steps to lock out systems:.

1. Press and hold **[Func]** .
2. While continuing to hold **[Func]** , rotate the scroll control to select a system you want to lock out.
3. While continuing to hold **[Func]** , press **L/O** to lock out the system.
4. Repeat Steps 2, 3, and 4 to lock out additional systems.

The preprogrammed systems provide a starting point; you will want to find out more information about your local radio systems so you can customize the programming to better suit your listening preferences.

Notes:

- You might hear transmissions on frequencies assigned to very distant stations. This will happen if a local system also uses the same frequency. Disregard the text tag for these transmissions (e.g. if you are in California, you aren't really receiving Florida transmissions even if the scanner displays *DADE COUNTY*).
- To free up memory, you can delete systems that you will not be monitoring. Refer to "Deleting Systems" on Page 70.
- Data used for the preprogrammed information was supplied courtesy of <http://www.radioreference.com> , the Internet's premier scanning resource (RadioReference is not affiliated with Uniden America Corporation).

| State             | County      | City                              | System           |
|-------------------|-------------|-----------------------------------|------------------|
| <b>Arizona</b>    |             |                                   |                  |
| Arizona           | Maricopa    | Avondale                          | Maricopa Conv    |
| Arizona           | Maricopa    | Capitol                           | Maricopa Conv    |
| Arizona           | Maricopa    | Chandler                          | Chandler MOT     |
| Arizona           | Maricopa    | Chandler                          | Maricopa Conv    |
| Arizona           | Maricopa    | El Mirage                         | Maricopa Conv    |
| Arizona           | Maricopa    | Fort McDowell<br>Indian Community | Maricopa Conv    |
| Arizona           | Maricopa    | Goodyear                          | Maricopa Conv    |
| Arizona           | Maricopa    | Salt River Indian<br>Community    | Maricopa Conv    |
| Arizona           | Maricopa    | Scotsdale                         | Maricopa Conv    |
| Arizona           | Maricopa    | Tempe                             | Tempe MOT        |
| Arizona           | Maricopa    | Tolleson                          | Maricopa Conv    |
| Arizona           | Maricopa    | Tonopah                           | Maricopa Conv    |
| Arizona           | Maricopa    | Wickenburg                        | Maricopa Conv    |
| <b>California</b> |             |                                   |                  |
| California        | Alameda     | Alameda                           | Alameda MOT      |
| California        | Alameda     | Albany                            | Alameda Conv     |
| California        | Alameda     | East Bay Park                     | Alameda Conv     |
| California        | Alameda     | Fremont                           | Alameda MOT      |
| California        | Alameda     | Hayward                           | Alameda MOT      |
| California        | Alameda     | Newark                            | Alameda MOT      |
| California        | Alameda     | Oakland                           | Oakland EDACS    |
| California        | Alameda     | Piedmont                          | Oakland EDACS    |
| California        | Alameda     | San Leandro                       | Alameda MOT      |
| California        | Alameda     | Union City                        | Alameda MOT      |
| California        | Los Angeles | Alhambra                          | Los Angeles Conv |
| California        | Los Angeles | Altaden Crest Valley              | Los Angeles Conv |
| California        | Los Angeles | Arcadia                           | Los Angeles Conv |
| California        | Los Angeles | Avalon                            | Los Angeles Conv |
| California        | Los Angeles | Baldwin Park                      | Los Angeles Conv |
| California        | Los Angeles | Bell                              | Los Angeles Conv |
| California        | Los Angeles | Bell Gardens                      | Los Angeles Conv |
| California        | Los Angeles | Beverly Hills                     | Los Angeles Conv |
| California        | Los Angeles | Burbank                           | Los Angeles Conv |
| California        | Los Angeles | Carson                            | Los Angeles Conv |
| California        | Los Angeles | Century                           | Los Angeles Conv |
| California        | Los Angeles | Claremont                         | Los Angeles Conv |
| California        | Los Angeles | College/Transit                   | Los Angeles Conv |
| California        | Los Angeles | Compton                           | Los Angeles Conv |
| California        | Los Angeles | Covina                            | Los Angeles Conv |
| California        | Los Angeles | Crescenta                         | Los Angeles Conv |
| California        | Los Angeles | Culver City                       | Culver City MOT  |
| California        | Los Angeles | Downey                            | Los Angeles Conv |
| California        | Los Angeles | El Segundo                        | Los Angeles Conv |
| California        | Los Angeles | Gardena                           | Los Angeles Conv |
| California        | Los Angeles | Glendora                          | Los Angeles Conv |
| California        | Los Angeles | Hawthorn                          | Los Angeles Conv |

## Preprogrammed Systems



| <b>State</b> | <b>County</b> | <b>City</b>          | <b>System</b>    |
|--------------|---------------|----------------------|------------------|
| California   | Los Angeles   | Hermosa Beach        | Los Angeles Conv |
| California   | Los Angeles   | Huntington Park      | Los Angeles Conv |
| California   | Los Angeles   | Industry             | Los Angeles Conv |
| California   | Los Angeles   | Inglewood            | Los Angeles Conv |
| California   | Los Angeles   | Irwindale            | Los Angeles Conv |
| California   | Los Angeles   | LA County            | Los Angeles Conv |
| California   | Los Angeles   | La Habra Heights     | Los Angeles Conv |
| California   | Los Angeles   | La Verne             | Los Angeles Conv |
| California   | Los Angeles   | Lakewood             | Los Angeles Conv |
| California   | Los Angeles   | Lancaster            | Los Angeles Conv |
| California   | Los Angeles   | Lennox               | Los Angeles Conv |
| California   | Los Angeles   | Lomita               | Los Angeles Conv |
| California   | Los Angeles   | Long Beach           | Los Angeles Conv |
| California   | Los Angeles   | Lost Hills           | Los Angeles Conv |
| California   | Los Angeles   | Manhattan Beach      | Los Angeles Conv |
| California   | Los Angeles   | Marina Del Rey       | Los Angeles Conv |
| California   | Los Angeles   | Maywood              | Los Angeles Conv |
| California   | Los Angeles   | Monrovia             | Los Angeles Conv |
| California   | Los Angeles   | Montebello           | Los Angeles Conv |
| California   | Los Angeles   | Monterey Park        | Los Angeles Conv |
| California   | Los Angeles   | Norwalk              | Los Angeles Conv |
| California   | Los Angeles   | Pasadena             | Los Angeles Conv |
| California   | Los Angeles   | Pico Rivera          | Los Angeles Conv |
| California   | Los Angeles   | Pomona               | Los Angeles Conv |
| California   | Los Angeles   | Redondo Beach        | Los Angeles Conv |
| California   | Los Angeles   | San Dimas            | Los Angeles Conv |
| California   | Los Angeles   | San Fernando         | Los Angeles Conv |
| California   | Los Angeles   | Santa Clarita Valley | Los Angeles Conv |
| California   | Los Angeles   | Santa Monica         | Los Angeles Conv |
| California   | Los Angeles   | Signal Hill          | Signal Hill MOT  |
| California   | Los Angeles   | South Bay            | Los Angeles Conv |
| California   | Los Angeles   | Temple City          | Los Angeles Conv |
| California   | Los Angeles   | Verdugo              | Los Angeles Conv |
| California   | Los Angeles   | Walnut               | Los Angeles Conv |
| California   | Los Angeles   | West Covina          | Los Angeles Conv |
| California   | Los Angeles   | West Hollywood       | Los Angeles Conv |
| California   | Los Angeles   | Whittier             | Los Angeles Conv |
| California   | Orange        | Brea                 | Orange MOT       |
| California   | Orange        | Costa Mesa           | Orange MOT       |
| California   | Orange        | La Habra             | Orange MOT       |
| California   | Orange        | Laguna Beach         | Orange MOT       |
| California   | Orange        | Orange County        | Orange MOT       |
| California   | Orange        | Santa Ana            | Orange MOT       |
| California   | Riverside     | Banning              | Riverside Conv   |
| California   | Riverside     | Beaumont             | Riverside Conv   |
| California   | Riverside     | Blythe               | Riverside Conv   |
| California   | Riverside     | Cathedral            | Riverside Conv   |
| California   | Riverside     | Corona               | Riverside Conv   |
| California   | Riverside     | Desert Hot Springs   | Riverside Conv   |
| California   | Riverside     | Hemet                | Riverside Conv   |

## Preprogrammed Systems

| <b>State</b> | <b>County</b> | <b>City</b>      | <b>System</b>     |
|--------------|---------------|------------------|-------------------|
| California   | Riverside     | Murrietta        | Riverside Conv    |
| California   | Riverside     | Palm Springs     | Palm Springs MOT  |
| California   | Riverside     | Palm Springs     | Riverside Conv    |
| California   | Riverside     | Riverside        | Riverside Conv    |
| California   | Riverside     | San Jacinto      | Riverside Conv    |
| California   | San Bernadino | Adelanto         | SanBernadinoE MOT |
| California   | San Bernadino | Barstow          | SanBernadinoD MOT |
| California   | San Bernadino | Big Bear         | SanBernadinoA MOT |
| California   | San Bernadino | Chino            | SanBernadinoA MOT |
| California   | San Bernadino | Chino            | SanBernadinoB MOT |
| California   | San Bernadino | Colton           | SanBernadinoA MOT |
| California   | San Bernadino | Fontana          | SanBernadinoB MOT |
| California   | San Bernadino | Greater Highland | SanBernadinoB MOT |
| California   | San Bernadino | Loma Linda       | SanBernadinoB MOT |
| California   | San Bernadino | Lucerne Valley   | SanBernadinoC MOT |
| California   | San Bernadino | Montclair        | SanBernadinoA MOT |
| California   | San Bernadino | Ontario          | SanBernadinoA MOT |
| California   | San Bernadino | Rancho Cucamonga | SanBernadinoB MOT |
| California   | San Bernadino | Redlands         | SanBernadinoB MOT |
| California   | San Bernadino | Rialto           | SanBernadinoB MOT |
| California   | San Bernadino | San Bernadino    | SanBernadinoA MOT |
| California   | San Bernadino | Twin Peaks       | SanBernadinoA MOT |
| California   | San Bernadino | Upland           | SanBernadinoA MOT |
| California   | San Bernadino | Wrightwood       | SanBernadinoA MOT |
| California   | San Bernadino | Yucaipa          | SanBernadinoB MOT |
| California   | San Diego     | Camp Pendalton   | San Diego MOT     |
| California   | San Diego     | Del Mar          | San Diego MOT     |
| California   | San Diego     | Escondido        | San Diego MOT     |

## Preprogrammed Systems

| <b>State</b>    | <b>County</b> | <b>City</b>      | <b>System</b>      |
|-----------------|---------------|------------------|--------------------|
| California      | San Diego     | Inland           | San Diego MOT      |
| California      | San Diego     | Monte Vista      | San Diego MOT      |
| California      | San Diego     | National City    | National City MOT  |
| California      | San Diego     | North County     | San Diego MOT      |
| California      | San Diego     | Rancho           | San Diego MOT      |
| California      | San Diego     | San Diego        | San Diego City MOT |
| California      | San Diego     | San Diego County | San Diego Conv     |
| California      | San Diego     | South Bay        | San Diego MOT      |
| California      | Santa Clara   | Gilroy           | Santa Clara Conv   |
| California      | Santa Clara   | Milpitas         | Santa Clara Conv   |
| California      | Santa Clara   | Mountain View    | Santa Clara Conv   |
| California      | Santa Clara   | Palo Alto        | Santa Clara Conv   |
| California      | Santa Clara   | San Jose         | Santa Clara Conv   |
| California      | Santa Clara   | Santa Clara      | Santa Clara Conv   |
| California      | Santa Clara   | Santa Clara      | Santa Clara MOT    |
| California      | Santa Clara   | Sunnyvale        | Santa Clara Conv   |
| <b>Florida</b>  |               |                  |                    |
| Florida         | Broward       | Broward          | Broward County MOT |
| Florida         | Broward       | Coconut Creek    | Broward Conv       |
| Florida         | Broward       | Coral Springs    | Coral Springs MOT  |
| Florida         | Broward       | Dania            | Hollywood EDACS    |
| Florida         | Broward       | Fort Lauderdale  | Ft.Lauderdale MOT  |
| Florida         | Broward       | Hollywood        | Hollywood EDACS    |
| Florida         | Broward       | Margate          | Coral Springs MOT  |
| Florida         | Broward       | Miramar          | Broward County MOT |
| Florida         | Broward       | Oakland Park     | Ft.Lauderdale MOT  |
| Florida         | Broward       | PembrokePines    | Broward Conv       |
| Florida         | Broward       | Plantation       | Plantation MOT     |
| Florida         | Broward       | Pompano          | Ft.Lauderdale MOT  |
| Florida         | Broward       | Pompano Beach    | Ft.Lauderdale MOT  |
| Florida         | Broward       | Sunrise          | Broward Conv       |
| Florida         | Dade          | Carol City       | Dade EDACS         |
| Florida         | Dade          | Cutler Ridge     | Dade EDACS         |
| Florida         | Dade          | Dade             | Dade Conv          |
| Florida         | Dade          | Dade             | Dade Fire EDACS    |
| Florida         | Dade          | Doral            | Dade EDACS         |
| Florida         | Dade          | Hammocks         | Dade EDACS         |
| Florida         | Dade          | Homestead        | Dade Conv          |
| Florida         | Dade          | Intracostal      | Dade EDACS         |
| Florida         | Dade          | Kendall          | Dade EDACS         |
| Florida         | Dade          | Miami            | Miami MOT          |
| Florida         | Dade          | Miami Beach      | Miami Beach MOT    |
| Florida         | Dade          | Miami Lakes      | Dade EDACS         |
| Florida         | Dade          | Miccosokuee      | Dade Fire EDACS    |
| Florida         | Dade          | Municipal        | Dade EDACS         |
| Florida         | Dade          | Northside        | Dade EDACS         |
| <b>Illinois</b> |               |                  |                    |
| Illinois        | Cook          | Alsip            | Cook Conv          |
| Illinois        | Cook          | Chicago          | Cook Conv          |

## Preprogrammed Systems

| <b>State</b>         | <b>County</b> | <b>City</b>        | <b>System</b>     |
|----------------------|---------------|--------------------|-------------------|
| Illinois             | Cook          | Englewood          | Cook Conv         |
| Illinois             | Cook          | Evergreen Park     | Cook Conv         |
| Illinois             | Cook          | Franklin Park      | Cook Conv         |
| Illinois             | Cook          | Hoffman            | NW Central MOT    |
| Illinois             | Cook          | Hometown           | Cook Conv         |
| Illinois             | Cook          | Merrion Park       | Cook Conv         |
| Illinois             | Cook          | Northlake          | Cook Conv         |
| Illinois             | Cook          | Northlake          | Cook Conv         |
| Illinois             | Cook          | Oak Lawn           | Cook Conv         |
| Illinois             | Cook          | Rosemont           | Cook Conv         |
| Illinois             | Cook          | Schaumburg         | Schaumburg MOT    |
| Illinois             | Cook          | Streamwood         | NW Central MOT    |
| Illinois             | Cook          | Veteran's Park     | Cook Conv         |
| <b>Massachusetts</b> |               |                    |                   |
| Massachusetts        | Middlesex     | Ashby              | Middlesex Conv    |
| Massachusetts        | Middlesex     | Ayer               | Middlesex Conv    |
| Massachusetts        | Middlesex     | Belmont            | Cambridge MOT     |
| Massachusetts        | Middlesex     | Cambridge          | Cambridge MOT     |
| Massachusetts        | Middlesex     | Shirley            | Middlesex Conv    |
| Massachusetts        | Middlesex     | Townsend           | Middlesex Conv    |
| <b>Michigan</b>      |               |                    |                   |
| Michigan             | Wayne         | Allen Park         | Wayne Conv        |
| Michigan             | Wayne         | Belleville         | Wayne Conv        |
| Michigan             | Wayne         | Canton             | Wayne Conv        |
| Michigan             | Wayne         | Dearborn           | Wayne Conv        |
| Michigan             | Wayne         | Garden City        | Wayne Conv        |
| Michigan             | Wayne         | Huron              | Wayne Conv        |
| Michigan             | Wayne         | Northville         | Wayne Conv        |
| Michigan             | Wayne         | Plymouth           | Wayne Conv        |
| Michigan             | Wayne         | Redford            | Wayne Conv        |
| Michigan             | Wayne         | Romulus            | Wayne Conv        |
| Michigan             | Wayne         | Sumpter            | Wayne Conv        |
| Michigan             | Wayne         | Van Buren          | Wayne Conv        |
| Michigan             | Wayne         | WSU                | Wayne Conv        |
| <b>Nevada</b>        |               |                    |                   |
| Nevada               | Clark         | Clark County       | Clark County MOT  |
| Nevada               | Clark         | Henderson          | Clark County MOT  |
| Nevada               | Clark         | Las Vegas          | Clark County MOT  |
| Nevada               | Clark         | North Las Vegas    | Clark County MOT  |
| <b>New York</b>      |               |                    |                   |
| New York             | New York      | Bronx              | New York Conv     |
| New York             | New York      | Brooklyn           | New York Conv     |
| New York             | New York      | Manhattan          | New York Conv     |
| New York             | New York      | New York           | New York Conv     |
| New York             | New York      | Queens             | New York Conv     |
| New York             | New York      | Staten Island      | New York Conv     |
| New York             | Suffolk       | Amangansett        | East Hampton MOT  |
| New York             | Suffolk       | Amityville Village | SuffolkCounty MOT |
| New York             | Suffolk       | Asharoken          | SuffolkCounty MOT |

## Preprogrammed Systems

| <b>State</b> | <b>County</b> | <b>City</b>        | <b>System</b>     |
|--------------|---------------|--------------------|-------------------|
| New York     | Suffolk       | Bridgehampton      | East Hampton MOT  |
| New York     | Suffolk       | East Hampton       | East Hampton MOT  |
| New York     | Suffolk       | East Hampton       | East Hampton MOT  |
|              |               | East Hampton       |                   |
| New York     | Suffolk       | Village            | East Hampton MOT  |
| New York     | Suffolk       | Islip Township     | SuffolkCounty MOT |
| New York     | Suffolk       | Lloyd Park         | SuffolkCounty MOT |
| New York     | Suffolk       | Montauk            | East Hampton MOT  |
| New York     | Suffolk       | Northport          | SuffolkCounty MOT |
| New York     | Suffolk       | Ocean Beach        | SuffolkCounty MOT |
| New York     | Suffolk       | Riverhead          | SuffolkCounty MOT |
| New York     | Suffolk       | Sag Harbor         | East Hampton MOT  |
| New York     | Suffolk       | Sag Harbor Village | East Hampton MOT  |
| New York     | Suffolk       | Smithtown          | SuffolkCounty MOT |
| New York     | Suffolk       | Springs            | East Hampton MOT  |
| New York     | Suffolk       | Suffolk County     | SuffolkCounty MOT |
| <b>Ohio</b>  |               |                    |                   |
| Ohio         | Cuyahoga      | Bay Village        | Cuyahoga Conv     |
| Ohio         | Cuyahoga      | Beachwood          | Cuyahoga Conv     |
| Ohio         | Cuyahoga      | Bedford            | Cuyahoga Conv     |
| Ohio         | Cuyahoga      | Bedford Heights    | Cuyahoga Conv     |
| Ohio         | Cuyahoga      | Bentleyville       | Cuyahoga Conv     |
| Ohio         | Cuyahoga      | Berea              | Cuyahoga Conv     |
| Ohio         | Cuyahoga      | Bratenhal          | Cuyahoga Conv     |
| Ohio         | Cuyahoga      | Brecksville        | Cuyahoga Conv     |
| Ohio         | Cuyahoga      | Broadview Heights  | Cuyahoga Conv     |
| Ohio         | Cuyahoga      | Brooklyn           | Parma EDACS       |
| Ohio         | Cuyahoga      | Brooklyn Heights   | Cuyahoga Conv     |
| Ohio         | Cuyahoga      | Brookpark          | Brook Park MOT    |
| Ohio         | Cuyahoga      | Chagrin Falls      | Cuyahoga Conv     |
| Ohio         | Cuyahoga      | Cleveland Heights  | Cuyahoga Conv     |
| Ohio         | Cuyahoga      | Cuyahoga           | Cuyahoga Conv     |
| Ohio         | Cuyahoga      | Cuyahoga Heights   | Cuyahoga Conv     |
| Ohio         | Cuyahoga      | East Cleveland     | Cuyahoga Conv     |
| Ohio         | Cuyahoga      | Euclid             | Cuyahoga Conv     |
| Ohio         | Cuyahoga      | Fairview Park      | Cuyahoga Conv     |
| Ohio         | Cuyahoga      | Garfield Heights   | Cuyahoga Conv     |
| Ohio         | Cuyahoga      | Gates Mills        | Cuyahoga Conv     |
| Ohio         | Cuyahoga      | Glenwillow         | Cuyahoga Conv     |
| Ohio         | Cuyahoga      | Highland Heights   | Cuyahoga Conv     |
| Ohio         | Cuyahoga      | Highland Hills     | Cuyahoga Conv     |
| Ohio         | Cuyahoga      | Hunting Valley     | Cuyahoga Conv     |
| Ohio         | Cuyahoga      | Independence       | Cuyahoga Conv     |
| Ohio         | Cuyahoga      | Lakewood           | Cuyahoga Conv     |
| Ohio         | Cuyahoga      | Linndale           | Parma EDACS       |
| Ohio         | Cuyahoga      | Lyndhurst          | Cuyahoga Conv     |
| Ohio         | Cuyahoga      | Maple Heights      | Cuyahoga Conv     |
| Ohio         | Cuyahoga      | Mayfield           | Cuyahoga Conv     |
| Ohio         | Cuyahoga      | Middleburg Heights | Brook Park MOT    |
| Ohio         | Cuyahoga      | Middleburg Heights | Cuyahoga Conv     |

## Preprogrammed Systems

| <b>State</b>        | <b>County</b> | <b>City</b>          | <b>System</b>     |
|---------------------|---------------|----------------------|-------------------|
| Ohio                | Cuyahoga      | Moreland Hills       | Cuyahoga Conv     |
| Ohio                | Cuyahoga      | Newburg Heights      | Cuyahoga Conv     |
| Ohio                | Cuyahoga      | North Olmsted        | Cuyahoga Conv     |
| Ohio                | Cuyahoga      | North Randall        | Cuyahoga Conv     |
| Ohio                | Cuyahoga      | North Royalton       | Brook Park MOT    |
| Ohio                | Cuyahoga      | North Royalton       | Cuyahoga Conv     |
| Ohio                | Cuyahoga      | Oakwood              | Cuyahoga Conv     |
| Ohio                | Cuyahoga      | Olmstead Falls       | Brook Park MOT    |
| Ohio                | Cuyahoga      | Olmsted Falls        | Cuyahoga Conv     |
| Ohio                | Cuyahoga      | Olmsted Township     | Cuyahoga Conv     |
| Ohio                | Cuyahoga      | Orange               | Cuyahoga Conv     |
| Ohio                | Cuyahoga      | Parma                | Parma EDACS       |
| Ohio                | Cuyahoga      | Parma Heights        | Brook Park MOT    |
| Ohio                | Cuyahoga      | Pepper Pike          | Cuyahoga Conv     |
| Ohio                | Cuyahoga      | Richmond Heights     | Cuyahoga Conv     |
| Ohio                | Cuyahoga      | Rocky River          | Cuyahoga Conv     |
| Ohio                | Cuyahoga      | Seven Hills          | Cuyahoga Conv     |
| Ohio                | Cuyahoga      | Shaker Heights       | Cuyahoga Conv     |
| Ohio                | Cuyahoga      | Solon                | Cuyahoga Conv     |
| Ohio                | Cuyahoga      | South Euclid         | Cuyahoga Conv     |
| Ohio                | Cuyahoga      | Strongsville         | Brook Park MOT    |
| Ohio                | Cuyahoga      | University Circle    | Cuyahoga Conv     |
| Ohio                | Cuyahoga      | University Heights   | Cuyahoga Conv     |
| Ohio                | Cuyahoga      | Valley View          | Cuyahoga Conv     |
| Ohio                | Cuyahoga      | Walton Hills         | Cuyahoga Conv     |
| Ohio                | Cuyahoga      | Warrensville Heights | Cuyahoga Conv     |
| Ohio                | Cuyahoga      | Westlake             | Cuyahoga Conv     |
| Ohio                | Cuyahoga      | Woodmere             | Cuyahoga Conv     |
| <b>Pennsylvania</b> |               |                      |                   |
| Pennsylvania        | Philadelphia  | Temple PD            | Philadelphia Conv |
| <b>Texas</b>        |               |                      |                   |
| Texas               | Bexar         | Alamo Heights        | Bexar Conv        |
| Texas               | Bexar         | Balcones Heights     | Bexar Conv        |
| Texas               | Bexar         | Bexar County         | Bexar Conv        |
| Texas               | Bexar         | Castle Hills         | Bexar Conv        |
| Texas               | Bexar         | Hollywood Park       | Bexar Conv        |
| Texas               | Bexar         | Kirby                | Bexar Conv        |
| Texas               | Bexar         | Leon Valley          | Bexar Conv        |
| Texas               | Bexar         | Live Oak             | Bexar Conv        |
| Texas               | Bexar         | Shavano Park         | Bexar Conv        |
| Texas               | Bexar         | Terrell Hills        | Bexar Conv        |
| Texas               | Bexar         | Universal City       | Bexar Conv        |
| Texas               | Bexar         | Windcrest            | Bexar Conv        |
| Texas               | Dallas        | Addison              | Carrolton MOT     |
| Texas               | Dallas        | Carrolton            | Carrolton MOT     |
| Texas               | Dallas        | Cockrell Hill        | Dallas MOT        |
| Texas               | Dallas        | Coppell              | Lewisville MOT    |
| Texas               | Dallas        | Dallas               | Dallas Conv       |
| Texas               | Dallas        | Dallas               | Dallas MOT        |
| Texas               | Dallas        | Desoto               | Dallas Conv       |

## Preprogrammed Systems

| <b>State</b> | <b>County</b> | <b>City</b>           | <b>System</b>     |
|--------------|---------------|-----------------------|-------------------|
| Texas        | Dallas        | Duncanville           | Dallas Conv       |
| Texas        | Dallas        | Farmers Branch        | Carrolton MOT     |
| Texas        | Dallas        | Flower Mound          | Lewisville MOT    |
| Texas        | Dallas        | Garland               | Garland MOT       |
| Texas        | Dallas        | Grand Prairie         | Grand Prairie MOT |
| Texas        | Dallas        | Highland Park         | Dallas Conv       |
| Texas        | Dallas        | Highland Village      | Lewisville MOT    |
| Texas        | Dallas        | Hutchins              | Dallas Conv       |
| Texas        | Dallas        | Irving                | Irving EDACS      |
| Texas        | Dallas        | Lake Cities           | Lewisville MOT    |
| Texas        | Dallas        | Lancaster             | Dallas Conv       |
| Texas        | Dallas        | Lewisville            | Lewisville MOT    |
| Texas        | Dallas        | Mesquite              | Mesquite MOT      |
| Texas        | Dallas        | Richardson            | Richardson EDACS  |
| Texas        | Dallas        | Rowlett               | Garland MOT       |
| Texas        | Dallas        | Sachse                | Garland MOT       |
| Texas        | Dallas        | Seagoville            | Dallas Conv       |
| Texas        | Dallas        | Sunnyvale             | Dallas Conv       |
| Texas        | Dallas        | University Park       | Dallas Conv       |
| Texas        | Dallas        | Wilmer                | Dallas Conv       |
| Texas        | Harris        | Arcola                | Starnet MOT       |
| Texas        | Harris        | Baytown               | Starnet MOT       |
| Texas        | Harris        | Brazoria County       | Starnet MOT       |
| Texas        | Harris        | Cy-Fair               | Harris Conv       |
| Texas        | Harris        | Cypress Creek         | Harris Conv       |
| Texas        | Harris        | Fresno                | Starnet MOT       |
| Texas        | Harris        | Ft Bend County        | Starnet MOT       |
| Texas        | Harris        | Fulshar               | Starnet MOT       |
| Texas        | Harris        | Galena Park           | Starnet MOT       |
| Texas        | Harris        | Harris County         | Starnet MOT       |
| Texas        | Harris        | Humble                | Starnet MOT       |
| Texas        | Harris        | Jersey Village        | Starnet MOT       |
| Texas        | Harris        | Katy                  | Starnet MOT       |
| Texas        | Harris        | Kendleton             | Starnet MOT       |
| Texas        | Harris        | Meadows               | Starnet MOT       |
| Texas        | Harris        | Needville             | Starnet MOT       |
| Texas        | Harris        | Pasadena              | Starnet MOT       |
| Texas        | Harris        | Pecan Grove           | Starnet MOT       |
| Texas        | Harris        | Richmond              | Starnet MOT       |
| Texas        | Harris        | Rosehill              | Harris Conv       |
| Texas        | Harris        | Rosenberg             | Starnet MOT       |
| Texas        | Harris        | Tomball               | Harris Conv       |
| Texas        | Harris        | Webster               | Starnet MOT       |
| Texas        | Harris        | West University Place | Starnet MOT       |
| Texas        | Harris        | Willow Fork           | Starnet MOT       |
| Texas        | Tarrant       | Arlington             | Arlington MOT     |
| Texas        | Tarrant       | Azle                  | Tarrant Conv      |
| Texas        | Tarrant       | Bedford               | NE Tarrant MOT    |
| Texas        | Tarrant       | Benbrook              | Tarrant Conv      |

## Preprogrammed Systems

| <b>State</b>      | <b>County</b> | <b>City</b>          | <b>System</b>     |
|-------------------|---------------|----------------------|-------------------|
| Texas             | Tarrant       | Burleson             | Tarrant Conv      |
| Texas             | Tarrant       | Colleyville          | NE Tarrant MOT    |
| Texas             | Tarrant       | Crowley              | Tarrant Conv      |
|                   |               | Dalworthington       |                   |
| Texas             | Tarrant       | Gardens              | Tarrant Conv      |
| Texas             | Tarrant       | Eagle Mount          | Tarrant Conv      |
| Texas             | Tarrant       | Eules                | NE Tarrant MOT    |
| Texas             | Tarrant       | Forest Hill          | Tarrant Conv      |
| Texas             | Tarrant       | Forest Hills         | Fort Worth MOT    |
| Texas             | Tarrant       | Fort Worth           | Fort Worth MOT    |
| Texas             | Tarrant       | Grapevine            | NE Tarrant MOT    |
| Texas             | Tarrant       | Haltom City          | Fort Worth MOT    |
| Texas             | Tarrant       | Haslet               | Tarrant Conv      |
| Texas             | Tarrant       | Hurst                | Tarrant Conv      |
| Texas             | Tarrant       | Keller               | NE Tarrant MOT    |
| Texas             | Tarrant       | Kennedale            | Fort Worth MOT    |
| Texas             | Tarrant       | Lake Worth           | Tarrant Conv      |
| Texas             | Tarrant       | North Richland Hills | Fort Worth MOT    |
| Texas             | Tarrant       | Rendon               | Tarrant Conv      |
| Texas             | Tarrant       | Richland Hills       | Fort Worth MOT    |
| Texas             | Tarrant       | Saginaw              | Tarrant Conv      |
| Texas             | Tarrant       | Southlake            | Fort Worth MOT    |
| Texas             | Tarrant       | Southlake            | NE Tarrant MOT    |
| Texas             | Tarrant       | Watauga              | Tarrant Conv      |
| Texas             | Tarrant       | Westlake             | NE Tarrant MOT    |
| Texas             | Tarrant       | White Settlement     | Tarrant Conv      |
| <b>Washington</b> |               |                      |                   |
| Washington        | King          | Airport              | PortOfSeattle MOT |
| Washington        | King          | Algona               | Seattle MOT       |
| Washington        | King          | Auburn               | Seattle MOT       |
| Washington        | King          | Bellevue             | Seattle MOT       |
| Washington        | King          | Bothell              | Seattle MOT       |
| Washington        | King          | Des Moines           | Seattle MOT       |
| Washington        | King          | Eastside             | Seattle MOT       |
| Washington        | King          | Enumclaw             | Seattle MOT       |
| Washington        | King          | Federal Way          | Seattle MOT       |
| Washington        | King          | Issaquah             | Seattle MOT       |
| Washington        | King          | Kent                 | Seattle MOT       |
| Washington        | King          | King County          | Seattle MOT       |
| Washington        | King          | Kirkland             | Seattle MOT       |
| Washington        | King          | Mercer Island        | Seattle MOT       |
| Washington        | King          | Muckleshoot          | Seattle MOT       |
| Washington        | King          | Normandy Park        | Seattle MOT       |
| Washington        | King          | Port                 | PortOfSeattle MOT |
| Washington        | King          | Redmond              | Seattle MOT       |
| Washington        | King          | Seattle              | Seattle MOT       |
| Washington        | King          | Snoqualmie           | Seattle MOT       |
| Washington        | King          | Tukwilla             | Seattle MOT       |
| Washington        | King          | Waterfront           | PortOfSeattle MOT |

## Preprogrammed Systems



---

---

# One-Year Limited Warranty

---

---

**Important:** Evidence of original purchase is required for warranty service.

**WARRANTOR: UNIDEN AMERICA CORPORATION** (“Uniden”)

**ELEMENTS OF WARRANTY:** Uniden warrants, for one year, to the original retail owner, this Uniden Product to be free from defects in materials and craftsmanship with only the limitations or exclusions set out below.

**WARRANTY DURATION:** This warranty to the original user shall terminate and be of no further effect 12 months after the date of original retail sale. The warranty is invalid if the Product is (A) damaged or not maintained as reasonable or necessary, (B) modified, altered, or used as part of any conversion kits, subassemblies, or any configurations not sold by Uniden, (C) improperly installed, (D) serviced or repaired by someone other than an authorized Uniden service center for a defect or malfunction covered by this warranty, (E) used in any conjunction with equipment or parts or as part of any system not manufactured by Uniden, or (F) installed or programmed by anyone other than as detailed by the Operating Guide for this product.

**STATEMENT OF REMEDY:** In the event that the product does not conform to this warranty at any time while this warranty is in effect, warrantor will repair the defect and return it to you without charge for parts, service, or any other cost (except shipping and handling) incurred by warrantor or its representatives in connection with the performance of this warranty. THE LIMITED WARRANTY SET FORTH ABOVE IS THE SOLE AND ENTIRE WARRANTY PERTAINING TO THE PRODUCT AND IS IN LIEU OF AND EXCLUDES ALL OTHER WARRANTIES OF ANY NATURE WHATSOEVER, WHETHER EXPRESS, IMPLIED OR ARISING BY OPERATION OF LAW, INCLUDING, BUT NOT LIMITED TO ANY IMPLIED WARRANTIES OF MERCHANTABILITY OR FITNESS FOR A PARTICULAR PURPOSE. THIS WARRANTY DOES NOT COVER OR PROVIDE FOR THE REIM-

**One-Year Limited Warranty**

---

---

BURSEMENT OR PAYMENT OF INCIDENTAL OR CONSEQUENTIAL DAMAGES. Some states do not allow this exclusion or limitation of incidental or consequential damages so the above limitation or exclusion might not apply to you.

**LEGAL REMEDIES:** This warranty gives you specific legal rights, and you might also have other rights which vary from state to state. This warranty is void outside the United States of America.

**PROCEDURE FOR OBTAINING PERFORMANCE OF WARRANTY:** If, after following the instructions in this Operating Guide you are certain that the Product is defective, pack the Product carefully (preferably in its original packaging). Include evidence of original purchase and a note describing the defect that has caused you to return it. The Product should be shipped freight prepaid, by traceable means, or delivered, to warrantor at:

Uniden America Corporation

Parts and Service Division

4700 Amon Carter Boulevard

Fort Worth, TX 76155

(800) 297-1023, 8:00 a.m. to 5:00 p.m., Central, Monday through Friday



**One-Year Limited Warranty**

FOR  
ACCESSORIES,  
GO ONLINE &  
WWW.UNIDEN.COM

REGISTER ONLINE TODAY!

THANK YOU FOR BUYING A UNIDEN PRODUCT.

A World Without Wires®

Uniden®

May be covered under one or more of the following U.S. patents.

|           |           |           |           |           |           |
|-----------|-----------|-----------|-----------|-----------|-----------|
| 4,398,304 | 4,409,688 | 4,455,679 | 4,461,036 | 4,521,915 | 4,597,104 |
| 4,627,100 | 4,841,302 | 4,888,815 | 4,932,074 | 4,947,456 | 5,014,348 |
| 5,199,109 | 5,408,692 | 5,428,826 | 5,438,688 | 5,448,256 | 5,465,402 |
| 5,471,660 | 5,483,684 | 5,530,296 | 5,548,832 | 5,571,071 | 5,574,995 |
| 5,577,076 | 5,589,430 | 5,600,223 | 5,642,424 | 5,710,992 | 5,859,875 |
| 5,896,422 | 5,981,346 | 5,991,603 | 6,012,158 | 6,025,788 | 6,034,573 |
| 6,064,270 | 6,266,521 |           |           |           |           |

©2004. Uniden America Corporation, Fort Worth, Texas  
Contains additional foreign articles. Custom manufactured in China.  
UBZZ01326ZZ