



CORNELL-DUBILIER ELECTRONICS

MODEL AR-40

SOLID STATE AUTOMATIC ANTENNA ROTOR SYSTEM



Downloaded by
Amateur Radio Directory

www.hamdirectory.info

GENERAL

The Cornell-Dubilier AR-40 is an all transistorized Television Antenna Rotor System designed to support and rotate large television antennas. This rotator will support stacked arrays and deep fringe area television antennas.

The AR-40 is rated to support and rotate antennas with up to 1.5 square feet of wind area. The maximum side thrust, or overturning momentum, is approximately 4000 inch pounds without guying.



PRE-INSTALLATION

In the interest of familiarization and checking the equipment, we recommend that the rotor system be set up and checked out prior to actual installation. Please follow the recommended pre-installation check on a step-by-step basis.

1. Remove the control box, rotator unit, and mounting hardware from the packing carton.
2. Check the equipment; if there is any apparent damage or parts missing, return the complete system to your dealer for a replacement.
3. Measure out the maximum amount of 5-wire lead-in cable required for your installation. Prepare all five wires on both ends of the cable by stripping off approximately 1/2" of the insulation. Care must be exercised so as not to cut any of the wire strands. Twist each wire to tighten the strands. It is recommended that you solder each wire to form a solid mass.
4. With the control box and rotator on the work bench, connect the cable between the two units. Make sure wires 1, 2, 3, 4, and 5 control box are to wires 1, 2, 3, 4, and 5 on the rotator respectively.

Caution: Make sure no loose strands of wire are touching adjacent terminals or the metal case of the rotator.

5. With the rotator sitting upright and connected to the control box by the five wire lead-in cable, plug the control box power cord into a convenient 115 VAC 50/60 cycle wall socket.
6. The system is now ready for a pre-installation test.
7. Turn the directional control to "S", momentarily press down on the control knob. The rotator will start to turn and the indicator light on the control box will come on. When the rotator reaches "S", it will automatically stop and the light will go off. Turn the control knob on around to "N" (clockwise), momentarily press the control knob. The rotator will turn to its complete clockwise position (N). Repeat the foregoing procedure in the counter clockwise direction. Leave the system in the "N" position (complete counter-clockwise). No power is applied to any component of the AR-40

when the indicator lamp is off. There is no manual on/off switch as the unit is totally automatic. If rotor light remains on at either full clockwise or counter-clockwise North, adjust pot shaft on underside of control box until light goes off.

8. Disconnect the 115 VAC 50/60 cycle power by removing the plug from the wall socket.
9. Remove the five wire lead-in cable from the control box and the rotator. It is recommended that the wires be tagged with the terminal numbers for ease of installation.
10. The system is now ready for installation.

Do not force knob past "N".

INSTALLATION

Now that the unit has been checked and you have become familiar with its operation, installation can proceed. The most important aspect to a good quality installation is neatness and well secured connections. All wires and cables should be dressed and fixed well. Clamps and guy wires that are not tightened tend to loosen in high wind conditions which could mean that your complete antenna system will be damaged.

1. Prior to installation, lay out all the equipment and tools to be used and check everything carefully.
2. For most mounting, typical requirements are:
 - a. Antenna
 - b. Rotor system
 - c. Main Mast (10' per section)
 - d. 3' upper mast (can be cut from a 10' section)
 - e. Guy wires (min. 3 per 10' section)
 - f. Mast base plate, chimney straps, etc.
 - g. Guy wire tie-down eyes (one per guy wire)
 - h. Five wire rotor control cable
 - i. Antenna lead-in cable (300 ohm twin or coaxial)
 - j. Antenna lead-in stand-off insulators (one per 4' of mast plus one for above and one for below the rotator (see plate two).

NOTICE TO SERVICEMAN: Leave this instruction sheet with the Customer. It contains his operating instructions.

Parts and Service can be obtained through your local dealer, or by writing to Cornell-Dubilier Electronics, Rotor Parts Department, 118 E. Jones Street, Fuquay-Varina, North Carolina 27526.

included. The flat rate charge includes rebuilding the unit and replacing all defective parts.

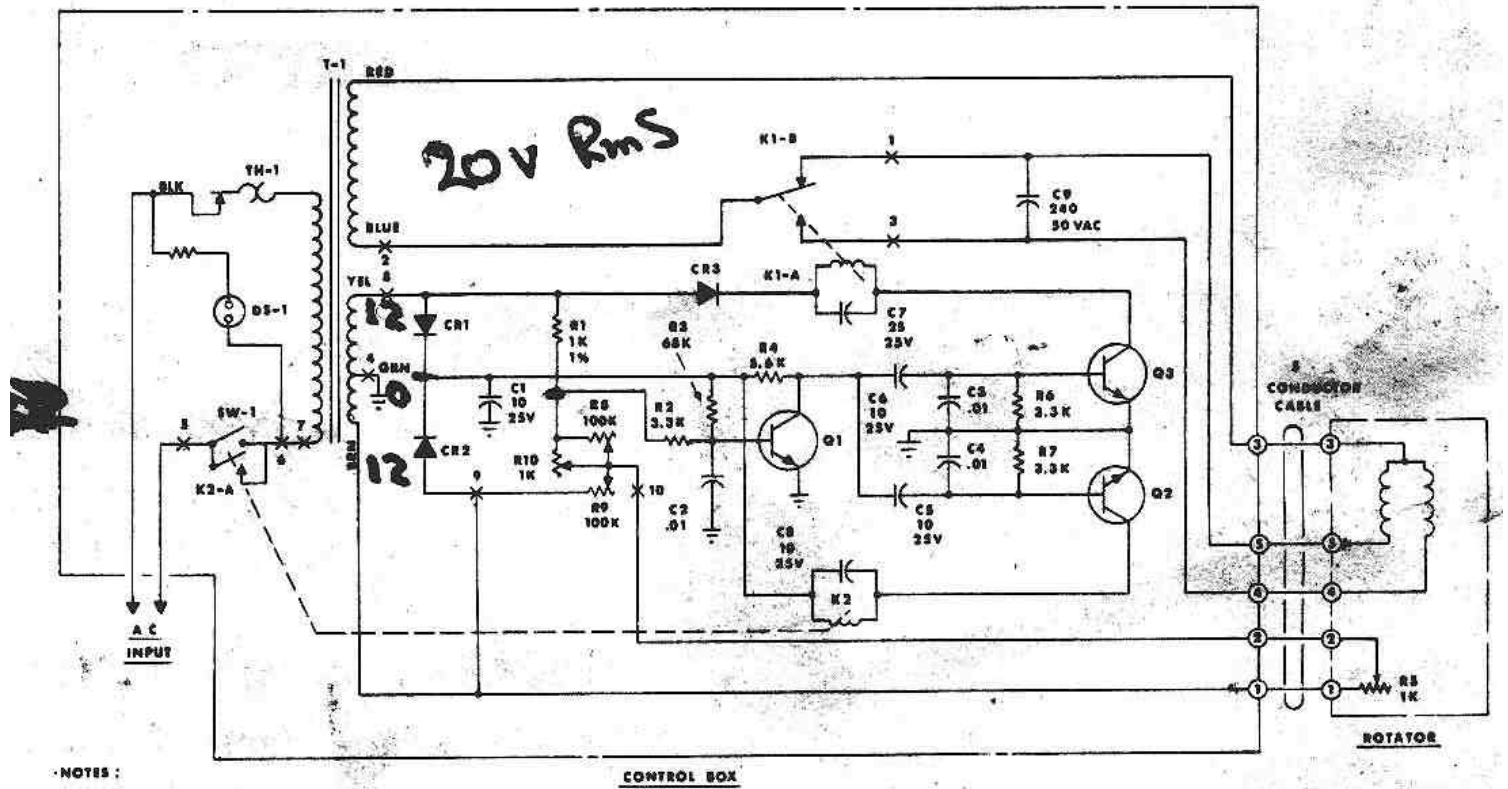

- NOTES:
1. ALL RESISTANCE VALUES ARE IN OHMS.
 2. ALL CAPACITANCE VALUES ARE IN MICROFARADS.
 3. RESISTOR TOLERANCE IS $\pm 10\%$ UNLESS OTHERWISE SPECIFIED.
 4. X DENOTES PRINTED CIRCUIT BOARD CONNECTION.
 5. SW-1 AND R10 ARE INTERCONNECTED AND PART OF THE DIRECTIONAL CONTROL KNOB.
 6. TH-1 THERMOSWITCH IS PART OF T-1 TRANSFORMER.

Plate 3 — SCHEMATIC

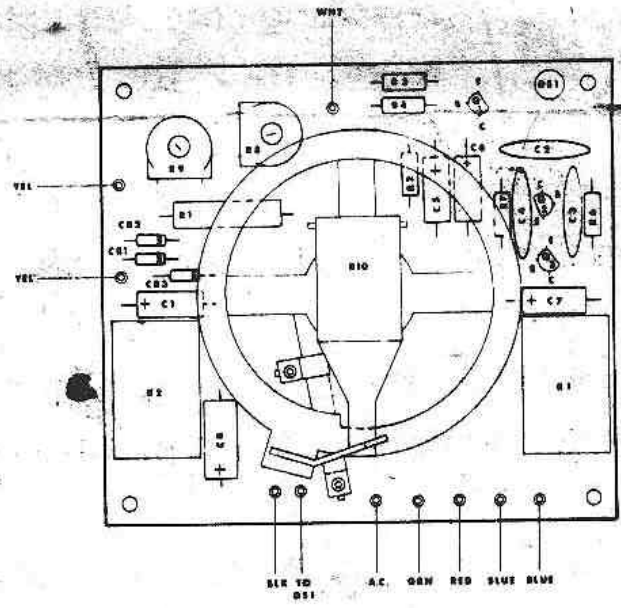

Plate 4 — PRINTED CIRCUIT BOARD ASSEMBLY

GABWA

CDE Rotor System AR-40

Cornell-Dubilier Electronics
Rotor Service Department
118 East Jones Street
Fuquay-Varina, N. C. 27526

For units that are in warranty, no charge will be made for repair. If the unit is out of warranty, the following flat rate charges apply:

Control box only	\$10.00
Rotator only	\$10.00
Complete unit	\$15.00

A check or money order for the amount indicated above should be included. The flat rate charge includes rebuilding the unit and replacing all defective parts.

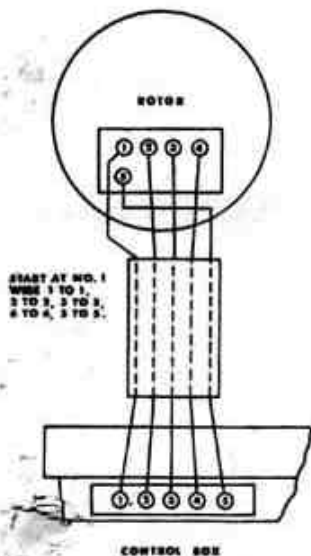

PLATE 1

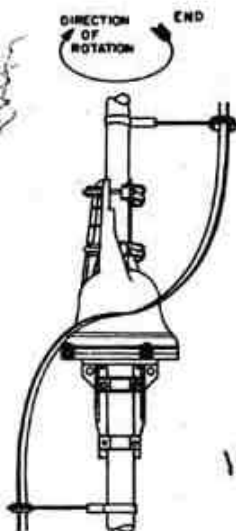

PLATE 2

12-0-12

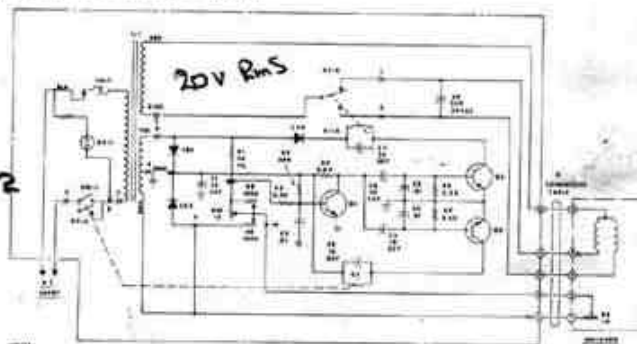

Plate 3 — SCHEMATIC

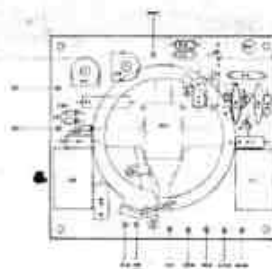

Plate 4 — PRINTED CIRCUIT BOARD ASSEMBLY

WARRANTY

CORNELL-DUBILIER ELECTRONICS warrants each new CORNELL-DUBILIER ROTOR to be free from defect in material arising from normal usage. Its obligation under this warranty is limited to replacing, or at its option repairing the rotor which, after regular installation and under normal usage and service, shall be returned within ONE (1) YEAR from date of original consumer purchase of the rotor to Cornell-Dubilier Electronics, Rotor Service Dept., 118 E. Jones St., Fuquay-Varina, N. C. 27526, together with satisfactory evidence of such purchase, and which shall be found to have been thus defective in accordance with the policies established by CORNELL-DUBILIER ELECTRONICS.

The obligation of CORNELL-DUBILIER ELECTRONICS does not include either the making or the furnishing of any labor in connection with the installation of such repaired or replacement rotor, nor does it include responsibility for any transportation expense.

CONDITIONS AND EXCLUSIONS

This warranty is expressly in lieu of all other agreements and warranties, expressed or implied, and CORNELL-DUBILIER ELECTRONICS does not authorize any person to assume for it the obligation contained in this warranty and neither assumes nor authorizes any representative or other person to assume for it any other liability in connection with such CORNELL-DUBILIER Rotor.

The warranty herein extends only to the original consumer and is not assignable or transferable, and shall not apply to any rotor which has been subject to alternation, misuse, negligence or accident.

CORNELL-DUBILIER ELECTRONICS
118 E. Jones Street
Fuquay-Varina, N. C. 27526

k. Electrical tape

3. Mount mast to roof, chimney, Bi-pod mount, or choice.
4. Mount the rotator on the mast with hardware supplied.
5. Attach one end of the five-wire to the rotator terminals. Use the same sequence as used on the pre-installation check. The cover and grommet must be slipped over the cable prior to attaching it to the terminals on the rotator.
6. Tape the rotor control cable to the mast at points 18" to 24" apart.
7. Attach the antenna lead-in stand-off bracket 36" to 48" apart. Connect the antenna lead-in to the antenna (follow manufacturer's recommendation). Run the antenna lead-in down the mast by inserting it in the insulators. Make sure you have enough slack for the 360° rotation. (The antenna rotates "N" to "E" (clockwise), therefore, slack should wrap clockwise around the mast. (See plate two.)
8. Attached the mast guy wires to the rotator or mast ring.
9. Raise the mast into position. Rotate the mast by hand, until the antenna receiving end is pointing in a northerly direction. Tighten the base clamp. Line up the mast in the vertical position and tighten and secure the guy wires.
10. Continue the antenna lead-in and five-wire control cable into the room where your T.V. set is to be located. Note: in a metal building or a mobile home, stand-off insulators should be used throughout for the antenna lead-in.
11. Connect the five-wire cable to the control box. Use the same sequence as used on the rotator. Note: make sure all connections are clean and that no wires or wire strands are touching unintended terminals.
12. Connect the antenna cable to the T.V. set.
13. Plug the control box line into the wall socket.
14. Check the rotor system operation as done in the pre-installation check.
15. The system is now ready for operation.

SERVICE

Cornell-Dubilier maintains a modern well staffed repair department for all CDE antenna rotors. If service is required, the unit should be packed securely and sent prepaid to:

AR-30/AR-40 CONTROL UNIT - PART KITS

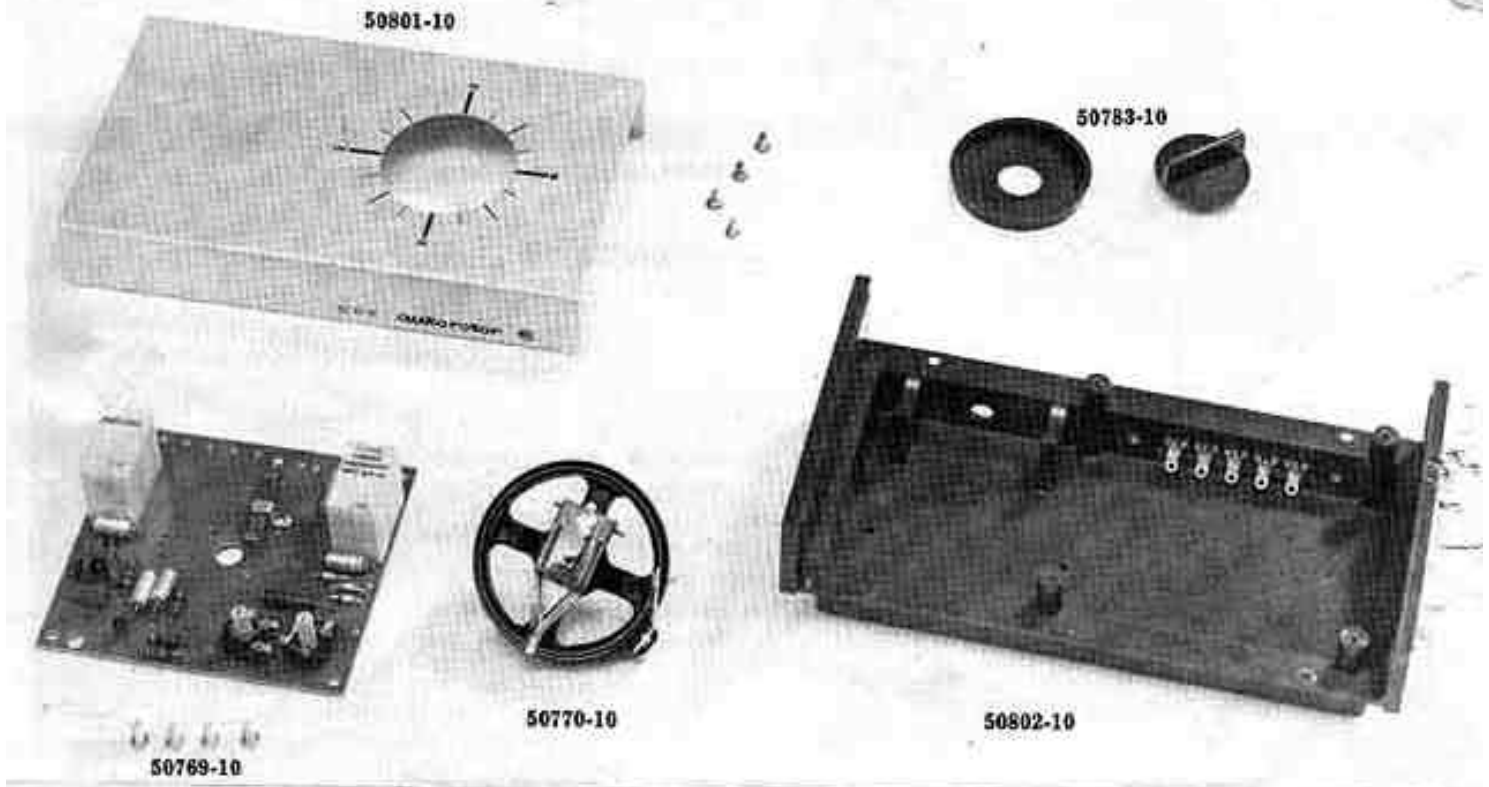

50796-10	Control unit, Complete	\$29.00	50778-10	Motor Start Capacitor Kit: C-9 (1 per kit)	1.65
50769-10	Printed Circuit Assembly Kit	14.50	50779-10	Resistor Kit: R1, R2, R3, R4, R6, and R7 (6 per kit)	1.00
50770-10	Potentiometer Kit; R-10 and Shaft Assy. (1 per kit)	5.80	50781-10	Line Cord Kit: 115 VAC (1 per kit)	1.00
50772-10	Relay Kit: K-2 (1 per kit)	4.00	50782-10	Terminal Kit: 5 terminal connector (1 per kit)	.50
50773-10	Relay Kit: K-1 (1 per kit)	4.50	50783-10	Knob & Eschutcheon Kit (1 per kit)	1.00
50774-10	Potentiometer Kit: R-8 and R-9, End of Rotation (2 per kit)	1.20	50784-10	Transformer Kit: 115 VAC 50/60HZ (1 per kit)	5.50
50775-10	Transistor Kit: Q1, Q2, and Q3 (3 per Kit)	1.90	50785-10	Transformer Kit: 230 VAC 50/60HZ	6.00
50776-10	Diode Kit: CR-1, CR-2 and CR-3 (3 per kit)	1.90	50801-10	Cover Kit (1 per kit)	3.00
50777-10	Capacitor Kit: C-1 thru C-8 (8 per kit)	2.50	50802-10	Chassis Kit: Chassis E/W Feet & Terminal Strip (1 per kit)	3.00

ORDER PARTS USING COMPLETE NUMBER & DESCRIPTION

To order parts, remit check or money order for total parts cost plus \$5.00 for postage and handling to: Cornell-Dubilier Electronics, Department "C", 118 E. Jones Street, Fuquay-Varina, N. C. 27626

50854-10 ROTATOR ASSEMBLY, COMPLETE 41.50
Includes LOWER MAST SUPPORT & HARDWARE

50425-10 MOUNTING HARDWARE KIT 3.60
Includes 4 U-BOLTS
8 NUTS & LOCKWASHERS
4 MAST CLAMPS
4 LOWER MAST SUPPORT SCREWS & HARDWARE

50304-10 UPPER MAST SUPPORT KIT 6.10

50855-10 MOTOR ASSEMBLY KIT 14.70
Includes MOTOR & PINION
POTENTIOMETER ASS'Y
TERMINAL BOARD ASSEMBLY
WIRING, SCREWS, MOTOR MTG. NUTS & LOCKWASHERS.

50420-10 MOTOR MOUNT PLATE KIT 1.80
Includes MOTOR MOUNT PLATE & STUDS,
3 MOUNTING SCREWS, WIRING WRAP LUG & WASHER

50422-10 SPUR GEAR KIT 3.00
Includes 3 ASSEM'D GEARS (SHT. PINION) UPPER 3
1 ASSEM'D GEAR (LG. PINION) UPPER L.
3 STACKED SPUR GEARS (LOWER R.)
5 SPACERS & WASHERS

50313-10 RING GEAR KIT 1.40

50427-10 BEARING STRAP ASSEMBLY KIT 1.60
Includes 12 BALL BEARINGS

50370-10 BASE KIT INCLUDES POSTS 4.25
(Does Not Include Stop Below)

50423-10 STOP ARM KIT .60
Includes STOP & SPRING WASHER

50424-10 BEARING RACE KIT 2.25
Includes RACE & 4 MOUNTING SCREWS

50349-10 MAST SUPPORT KIT 3.70
Includes LOWER MAST SUPPORT, INSPECTION PLATE & GROMMET, 2 MOUNTING SCREWS FOR INSPECTION PLATE

50428-10 GREASE FOR ONE ASSEMBLY .35

HDWE. INCLUDED IN 50425-10 KIT

AR-40 ROTATOR

ORDER PARTS USING COMPLETE NUMBER & DESCRIPTION
To order parts, remit check or money order for total parts cost plus \$.50 for postage and handling to: Cornell-Dubilier Electronics, Department "C", 118 E. Jones Street, Fuquay-Varina, N. C. 27526