

VHF FM HANDHELD TRANSCEIVER

DJ-191

UHF FM HANDHELD TRANSCEIVER

DJ-491**INSTRUCTION MANUAL****ALINCO, INC.**

Head office: *TWIN 21* MID Tower Building 25F
1-61, 2-Chome, Shiromi, Chuo-ku, Osaka 540-8580 Japan
Phone: 06-946-8150 Fax: 06-946-8175 Telex: 63086
E-mail: 101243.1446@compuserve.com

U.S.A.: 438 Amapola Ave., Suite 130, Torrance, CA 90501-6201 U.S.A.
Phone: 310-618-8616 Fax: 310-618-8758
<http://www.alinco.com/>

Germany: Eschborner Landstrasse 55, 60489 Frankfurt am Main, Germany
Phone: 069-786018 Fax: 069-789-60766

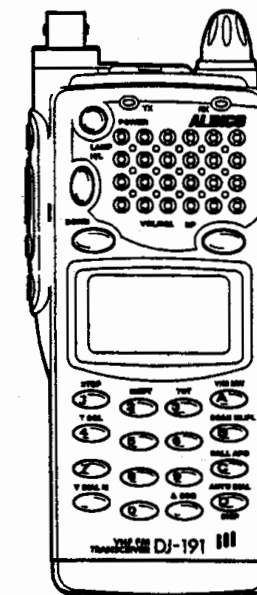

Thank you for purchasing this ALINCO transceiver.

To obtain optimum performance from this transceiver, read this Instruction Manual thoroughly, and keep it for future reference.

The LCD display examples in this Instruction Manual use the DJ-191T's LCD display.

Table of Contents

1. INTRODUCTION	1
2. INNOVATIVE AND NEW FEATURES	1
3. ACCESSORIES	1
3-1 Standard Accessories	1
3-2 Optional Accessories	2
4. INSTALLATION	2
4-1 Mobile Installation	3
4-2 Base Station Installation	3
4-3 Charging Your Battery	3
5. SPECIFICATIONS	4
5-1 General	4
5-2 Transmitter	5
5-3 Receiver	5
6. QUICK REFERENCE	6
6-1 Receive	6
6-2 Transmit	7
6-3 Programming	8
6-4 Scanning	9
6-5 Auto Dial	10
6-6 DSQ (DTMF Code Squelch) Function	11
7. CONTROLS and FUNCTIONS	12
7-1 Top, Front, Sides and Rear View	12
7-2 DTMF Keypad Operation	16
7-3 LCD Display	17
8. GETTING STARTED	19
8-1 Receiving	19
Keypad Direct Entry	19
Step Key	19
Changing Frequency in One MHz Step	20
Clearing Entry	20
8-2 Transmitting	20
8-3 Transceiver Modes	21
VFO (Variable Frequency Oscillator) Mode	21
Memory Mode	21
Programming a Memory Channel	21
Scroll Memory	21
8-4 Other Functions	22
Battery Save Function (BS)	22
Beep ON/OFF	22
KL (Key Lock)	22
FL (Frequency Lock)	22
APO (Automatic Power Off)	23
CTCSS Tone Frequencies	23
Cable Cloning	23
8-5 Resetting	25
8-6 CTCSS Decoder Unit EJ-28U Installation	25
REFERENCE	26
APPENDIX	29

NOTICE

This equipment has been tested and found to comply with the limits pursuant to Part 15 of the FCC Rules. These limits are designed to provide reasonable protection against harmful interference in a residential installation. This equipment generates, uses, and can radiate radio frequency energy, and if not installed and used in accordance with the instructions, may cause harmful interference to radio communications. However, there is no guarantee that interference will not occur in a particular installation. If this equipment does cause harmful interference to radio or television reception, which can be determined by turning the equipment off and on, the user is encouraged to try to correct the interference by one or more of the following measures.

- *Reorient to relocate the receiving antenna.*
- *Increase the separation between the equipment and receiver.*
- *Connect the equipment into an outlet on a circuit different from that which the receiver is onnected.*
- *Consult the dealer or an experienced radio/TV technician for help.*

Information in this document are subject to change without notice or obligation. All brand names and trademarks are the property of their respective owners. Alinco cannot be liable for pictorial or typographical inaccuracies. Some options and/or accessories are unavailable in certain areas. ©Copyright 1996-1997 All rights reserved. No part of this document may be reproduced, copied, translated or transcribed in any form or by any means without the prior written permission of Alinco, Inc., Osaka, Japan. English Edition Printed in Japan

1. INTRODUCTION

We at Alinco would like to thank you for purchasing the ALINCO transceiver. Radios and other products made by ALINCO rank as some of the finest in the world. Your transceiver has been manufactured and tested very carefully at the factory and will give you satisfactory operation for many years.

We are confident that you will be very satisfied with your choice of this fine ALINCO radio.

2. INNOVATIVE AND NEW FEATURES

The transceiver features some of the most advanced features and reliable engineering available anywhere. Our design policy at ALINCO is focused on developing innovative usable features, including the following:

- Easy to readout LCD.
- Comes equipped with a 50 CTCSS Tone encoder, and with the optional EJ-28U Tone Squelch Decoder unit, the CTCSS Tones can be decoded for selective receiving.
- Tone Burst (1750Hz) feature comes built into the transceiver.
- T.O.T. (Time Out Timer) can be set to a Duty Cycle most accommodating to the user's requirements.
- Nine Autodial Memories easily accessed from the DTMF keypad with redial function.
- Cable Cloning function. (not for DJ-491C)
- Direct frequency entry from the DTMF keypad
- Independent Low power output PTT key (DJ-191T/491TA1 ~ TA3)
- Independent TX LED and RX LED

3. ACCESSORIES

3-1 Standard Accessories

When you unpack the ALINCO transceiver, you will find these standard accessories:

- Ni-Cd battery (optional for DJ-491C)*
- EDC-63 (120V AC) Wall charger (T Version)*
- EDC-64 (220V AC) Wall charger (E Version)*
- Flexible rubber duckie antenna (not applicable for DJ-491C)*
- Belt clip with two screws
- Hand strap
- Instruction Manual

*Accessories may differ depending on the version you bought.

3-2 Optional Accessories

EJ-28U	CTCSS Decoder Unit
EBP-33N	(4.8V DC 650mAH) Ni-Cd battery
EBP-34N	(4.8V DC 1200mAH) Ni-Cd battery
EBP-35N	(7.2V DC 900mAH) Ni-Cd battery
EBP-36N	(9.8V DC 650mAH) Ni-Cd battery
EBP-37N	(4.8V DC 700mAH) Ni-Cd battery
EDH-16	Dry-cell battery case (AA x 4)
EDC-36	Mobile Cigarette lighter adapter with active noise filter
EDC-37	External DC supply cable
EDC-60	(120V AC) Rapid charger
EDC-61	(220V AC) Rapid charger
EDC-63	(120V AC) Wall charger
EDC-64	(220V AC) Wall charger
EMS-9	Speaker microphone
EME-12	Headset with VOX
EME-13	Earphone and mic with VOX
EME-6	Earphone
ESC-28	Softcase (for use with EBP-33N)
ESC-29	Softcase (for use with EBP-37N)
ESC-30	Softcase (for use with EBP-34N/35N/36N)
EBC-6	Mobile bracket
EJ-27D	SmarTrunk™ Logic Board (for commercial versions only)

4. INSTALLATION

External Antenna Installation (Not applicable for DJ-491C):

When an external antenna is used, 50 ohms coaxial cable is required for all antenna installations.

Please refer to the antenna manufacturer's manual for the proper installation and mounting information. After installing your antenna, ensure that you have the proper matching and best possible SWR reading. High SWR or improper matching can cause severe damage to your unit and may void the warranty.

(Note: When your DJ-191 is used with an external antenna, you may experience some intermodulation problem from other communication services. This is caused due to the high sensitivity of the DJ-191's receiver front-end circuit and its design for wideband operation. If it is the case, we recommend you to use an antenna that has a lower gain or the rubber duckie antenna which comes standard with the radio.)

Caution: High RF environments can cause severe damage to your unit. Ensure that you are not in a High RF environment when operating your radio.

4-1 Mobile Installation

1. Location

The transceiver may be installed in any position* in your car, where the controls are easily accessible while maintaining safe operation of your vehicle.

(*local regulations may apply)

2. Power Requirements

The transceiver can be operated from any regulated 12 or 13.8V DC negative ground source.

For mobile use, use always with the optional EDC-36 cigarette lighter adapter with active noise filter.

4-2 Base Station Installation

For a fixed base operation, 4.8V DC ~ 13.8V DC Regulated Power Supply providing a minimum of 2A continuous is required.

When using the optional EDC-37 DC cable, connect the red lead of to the Positive (+) terminal, and the black lead to the Negative (-) terminal of the DC Power Supply.

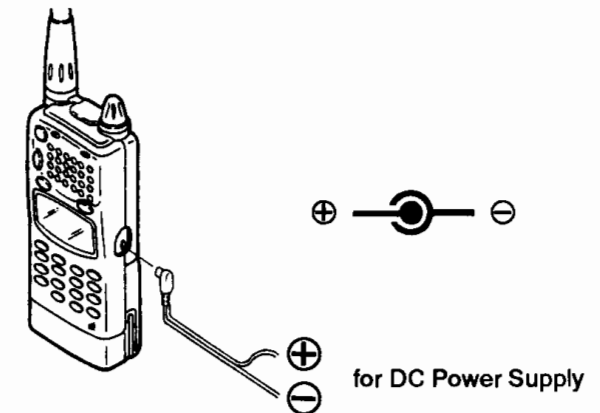

4-3 Charging Your Battery

Before operating your transceiver, you must charge your Ni-Cd battery with the wall charger that comes standard with your radio.

It will take approx. 12 to 14 hours to be fully charged.

5. SPECIFICATIONS

The specifications outlined for this product are for specified TX range only. No guarantee or warranty, either specific or implied, will apply to any function or specification outside the specified TX range, even for reception performance. Individual radios may experience different performance and/or specification levels.

Any modification for the purpose of operation outside of the specified TX range will result in voiding any warranties associated with this transceiver and may be a violation of FCC regulations.

All specifications and features are subject to change without notice or obligation.

5-1 General

Frequency Coverage	RX	TX
DJ-191T (U.S. Amateur Version)	136.000 ~ 173.995MHz	144.000 ~ 147.995MHz
DJ-191E (European Amateur Version)	144.000 ~ 145.995MHz	144.000 ~ 145.995MHz
DJ-191TA1 (Commercial Version)	136.000 ~ 173.995MHz	136.000 ~ 155.000MHz
DJ-191TA2 (Commercial Version)	136.000 ~ 173.995MHz	150.000 ~ 173.995MHz
DJ-491C (European LPD Version)	433.0625 ~ 434.7875MHz	433.0625 ~ 434.7825MHz
DJ-491TA1 (Commercial Version)	400.000 ~ 420.000MHz	400.000 ~ 420.000MHz
DJ-491TA2 (Commercial Version)	450.000 ~ 470.000MHz	450.000 ~ 470.000MHz
DJ-491TA3 (Commercial Version)	430.000 ~ 450.000MHz	430.000 ~ 450.000MHz
Channel Spacing:	5, 10, 12.5, 15, 20, 25, 30kHz steps	
Memory Channels:	40 Channels + 1 Call Channel Memory	
Antenna Impedance:	50 Ohms unbalanced	
Frequency Stability:	± 5 ppm	
Microphone Input Impedance:	2K Ohms nominal.	
Signal Type:	F3E (FM)	
Power Supply Requirements:	4.8 ~ 13.8V DC (4.8V DC standard)	
Current Consumption at 13.8V DC:	Transmitting: Approx. 1.5 Amp. in High Power Setting (0.1 Amp for DJ-491C) Receiving: Squelched Approx. 50mA	
Operating Temperature:	- 10 to + 60 degrees (Celsius), 14 to 140 degrees (Fahrenheit)	
Ground:	Negative	
Dimensions:	57(W) × 151(H) × 28(D) mm without projections, with EBP-37N	
Weight:	Approx. 300g (with EBP-37N)	
DTMF:	16 Buttons Keypad	
Subaudible Tones (CTCSS):	Encoder installed (50 tones)	
European Standard:	ETS-300220 (for DJ-491C only)	

5-2 Transmitter

Output Power:	High: Approx. 5W (at 13.8V DC) / Low: Approx. 0.8W 10mW in High or Low for DJ-491C
Emission Mode:	F3E (FM)
Modulation System:	Variable reactance FM
Max. Freq. Deviation:	± 5kHz
Spurious Emission:	- 70dB or under below carrier level
Tone Frequency:	67.0 to 254.1 Hz (50 selections)
Microphone:	Electret Condenser type
Operating Mode:	Simplex/Semi Duplex: Offset 5kHz or 12.5kHz steps
CTCSS Encoder:	Built-in and included as standard

5-3 Receiver

Receiving System:	Superheterodyne Dual Conversion
Sensitivity (12dB SINAD):	DJ-191 Less than - 16dB μ DJ-491 Less than - 12dB μ
Intermediate Frequency:	DJ-191 1st IF 21.7MHz / 2nd IF 450kHz DJ-491 1st IF 45.1MHz / 2nd IF 455kHz
Selectivity:	More than ± 6kHz at - 6dB, Less than ± 12kHz at - 60dB
Audio Output:	More than 200mW (at 10% THD)
Speaker Impedance:	8 Ω

6. QUICK REFERENCE

(For details, see Section 7 and onwards.)

6-1 Receive

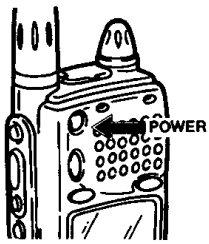

POWER ON

Insert the Ni-Cd battery to the radio. Press the power switch on.

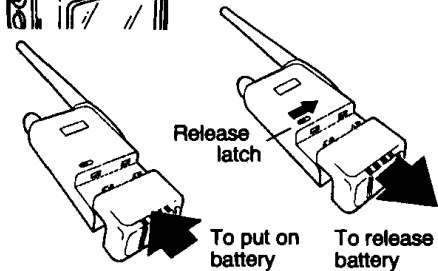

To put on battery To release battery

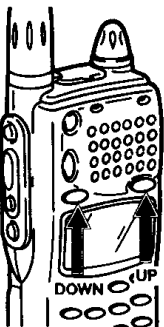

VOLUME

Press the key to increase the speaker volume. Press the key to decrease the speaker volume.

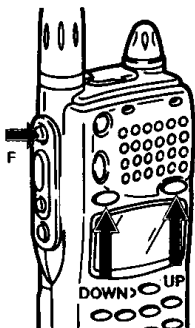

SQUELCH

While holding the (Function) key, press either the key or key until background noise disappear.

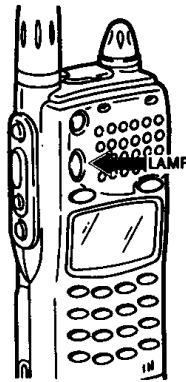

LAMP

Press the key to illuminate the LCD. It will automatically go off after five seconds.

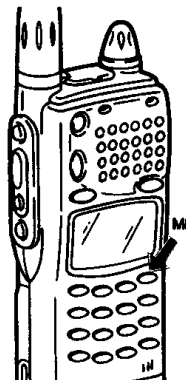

VFO MODE

Press the key so that "M" or "C" icon above the frequency segment on the LCD does not appear.

VFO FREQUENCY

Use the DTMF keypad and enter a frequency. Be sure to enter all digits until the completion high tone beep is heard, even if the last digit is zero. Depending on the selected channel step, last one or two digit(s) may be limited (or compensated) to a frequency permissible in such a step.

6-2 Transmit

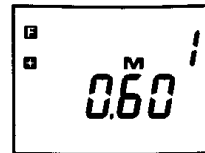

SIMPLEX

Press and hold key on the side, then press the key so that or is not shown on the LCD. (Press PTT on the side once to exit.)

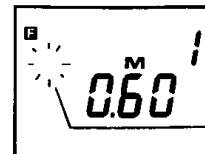
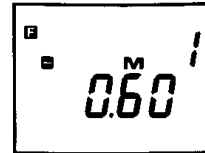

and disappear

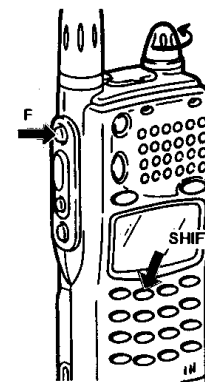

OFFSET

Press and hold the key, then press the key repeatedly until the display indicates either the or icon on the left side above the frequency segment of the LCD. Simplex operation is indicated as absence of either the or icon. Rotate the Main Tuning Dial to change offset frequency. means transmit will

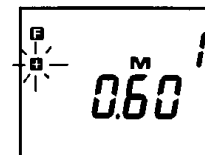

take place on the frequency shifted upwards by the

shown offset than the receiving frequency; means downwards in the same sense. (Press PTT on the side once to exit.)

TONE ENCODE

Press and hold the key, then press the key. Rotate the Main Tuning Dial for the desired tone. The icon appears on the top left of the LCD. (Press PTT on the side once to exit.)

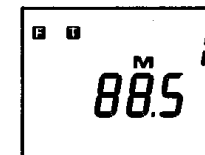
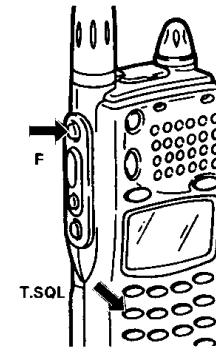

POWER SETTING (Not applicable for DJ-491C)

Press and hold the key, then press the key to select the desired output power setting. When the "L" (Low) icon is NOT displayed on the bottom left of the LCD, the radio is set on the high power setting.

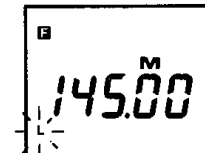
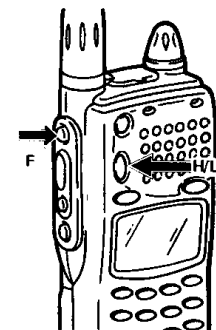

6-3 Programming

MEMORY MODE





Press the  key to display the "M" icon above the frequency segment of the LCD.



Pressing the same key again will bring back the VFO mode (the "M" icon disappears).

MEMORY SCROLL



Enter the MEMORY MODE, rotate the Main Tuning Dial.

MEMORY WRITE



1. Enter the MEMORY MODE.
2. Rotate the Main Tuning Dial to select the desired memory channel to program.
3. Enter the VFO MODE. Set the frequency, tone and shift accordingly.
4. Press and hold the  key, then press the  key to store the information into the memory channel. (Stored information: Frequency, Offset, Shift direction, CTCSS setting, CTCSS frequency, Power H/L, DSQ setting, DSQ code, Skip, Battery Save setting.)
5. A high tone beep will sound indicating that the programming is completed successfully.
6. Memorized items in a channel may be temporarily changed while you stay on that channel, but the written information remains as originally programmed. The original items will be called if you change the memory elsewhere (or to VFO) then come back to the mem-

ory channel, unless re-programmed with  and  keys.

MEMORY ERASE

1. Enter the MEMORY MODE.
2. Rotate the Main Tuning Dial to select the memory channel to erase.
3. Press and hold the  key, then press the  key to erase the program information on the memory channel.
4. A high tone beep will sound and the flashing "M" icon will appear on the LCD indicating that the memory content has been erased.

MEMORY SKIP

1. Enter the MEMORY MODE. Rotate the Main Tuning Dial to the channel you desire to skip during scanning operation.
2. Press and hold the  key, then press the  key.
3. The frequency decimal point will disappear indicating that the memory channel will be skipped when scanning.
4. To cancel the MEMORY SKIP, repeat these steps.



MEMORY CHANNEL DISPLAY MODE

Instead of displaying a frequency, in memory mode, the corresponding memory channel number only may be displayed. In this mode you cannot entre VFO and you cannot program or re-program a memory channel unless you first exit the Memory Channel Display Mode. To entre this mode, first program FL or KL (see Section 8-4 Other Func-

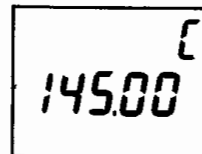

tions), and input through keypad #631. The display turns to Channel Number. (At least one channel has to be already programmed when you do this, or else "ch- ξ r" will appear.) Then cancel the FL or KL. Where "skip" channels have been set, the hyphen between "ch" and the channel number is not displayed. Repeat the same steps to exit this mode and get back the frequency display.



CALL CHANNEL



Press the  key. The "C" icon will appear on the top right of the LCD. Press  to come back to the previous channel.

CALL CHANNEL WRITE

1. Enter the MEMORY MODE.
2. Rotate the Main Tuning Dial to select the call channel.
3. Enter the VFO MODE. Set the frequency, tone and shift accordingly.
4. Press and hold the  key, then press the  key to store the information into the call channel.
5. A high tone beep will sound indicating that the programming is completed successfully.

Note: SCAN,  ,  keys, and the Main Tuning Dial are not operable in the CALL CHANNEL mode.

6-4 Scanning

Transceiver has the timer scan function. In this operation, scan stops at a busy channel and resumes after 5 seconds.

VFO (BAND) SCAN

Enter the VFO MODE. Press the  key, and the frequency decimal point will start blinking to indicate the scanning mode.

MEMORY SCAN

Enter the MEMORY MODE, and press the  key. (Will not start scanning if the call channel is indicated.)

SCAN DIRECTION



In the SCAN MODE, rotate the Main Tuning Dial counter-clockwise to scan downward and clockwise to scan upward.

STOP SCAN

Press the  key again, or press the PTT key.

Note: For those memories programmed with SKIP (see following section), they will be passed without receiving while scanning.

SCAN SKIP

Press and hold the  key and press the  key. Decimal point disappears from the frequency display, and the channel will be skipped when scanning.

6-5 Auto Dial

PROGRAM AUTO DIAL MEMORY

1. Press and hold the **F** key, then press the **0** key. The frequency indication of the LCD will go blank.
2. Rotate the Main Tuning Dial to select an auto dial memory location from 1 ~ 9.
3. Enter up to 16 digits (inclu. pause) thru the DTMF keypad.
4. To complete, press either the **A** key or **PTT** switch.

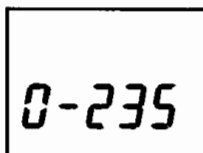

Note:

To enter the pause, press and hold the **F** key, and press the **0** key. It will be indicated with the “-” icon on the LCD. To clear the memory contents, press and hold the **F** key, then press the **C** key.

TRANSMIT AUTO DIAL MEMORY

1. Press and hold the “PTT” switch, and press the **0** key. Then the auto dial memory location number on the keypad. (The number key must follow the **0** key within 4 seconds.)
2. The contents of the auto dial memory pressed by the number key will be transmitted.

REDIAL MEMORY

1. While pressing the **PTT** key, press the **0** key.

2. Within four seconds after pressing the **0** key, press the **0** key on the keypad.
3. The contents of the last dialed DTMF string will be re-transmitted.

AUTO DIAL WITHOUT TRANSMITTING (WHILE RECEIVING)

1. Without pressing the **PTT** key, press the **0** key followed by a memory location number key.
2. The memory content DTMF will be heard without transmitting.

AUTO DIAL TIMING CHANGE

Refer to page 11 “Note:” and page 29 “Appendix”.

6-6 DSQ (DTMF Code Squelch) Function

DSQ (DTMF CODE SQUELCH) serves like the tone squelch. While the tone squelch utilizes the continuous sub-audible tone to unmute the squelch, DSQ uses combination of three DTMF tones as a squelch code.

SETTING A DSQ CODE



1. Press and hold the **F** key, then press the **0** key.
2. The “DSQ” icon will appear on the LCD, and the DSQ code will displayed. The factory's initial setting is “ 000 ”.
3. Enter three digits of numbers from the DTMF keypad.
4. To complete the setting, press either the **A** key or the **PTT** switch.

DSQ CALLING

After setting the DSQ code (the “DSQ” icon is displayed on the LCD), press the **PTT** switch.

DSQ RECEIVING



1. When the set DSQ code signal is received, the DTMF squelch will unmute and the “DSQ” icon starts blinking.
2. To respond to the call, simply press the **PTT** switch and talk into the microphone as usual.

3. If there is no operation activity for two seconds after the “DSQ” icon is blinked, the DTMF squelch will mute automatically. The “DSQ” icon, however, continues to blink until a operation is done.

Note:

Applicable both to AUTO DIALER and DSQ, you can change the pause time from the moment **PTT** is pressed to the start of emitting the first digit. To do this, press and hold the **F** key and press **0** key. The display will show “ dt-0.4 ” as default, meaning that the pause time is 0.4 second. Now turn the dial knob to choose one of 0.1, 0.4, 0.7, or 1.0 second. Press **PTT** to finish and exit. Also refer to page 29 “Appendix” for other functions related to DSQ.

7. CONTROLS/FUNCTIONS

7-1 Top, Front, Sides and Rear View

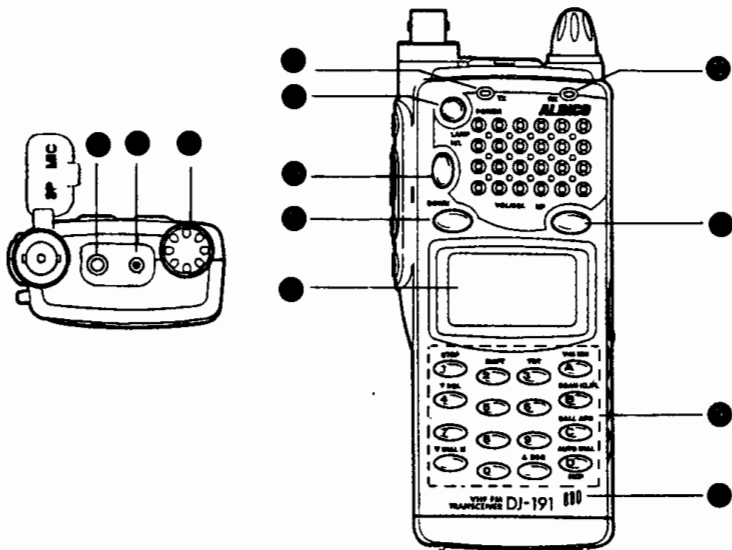

1 LCD DISPLAY PANEL

Highly visible under all lighting conditions, the LCD panel displays functional information during transceiver operations. Refer to LCD DISPLAY section of this manual.

2 MAIN TUNING DIAL

The main tuning dial/knob may be rotated in either direction to select transmit/receive frequencies, memory channels, transmit frequency offsets, and sub-audible tones.

3 EXTERNAL MICROPHONE JACK

When the external microphone is preferred, plug in a 2.5mm stereo plug into this jack.

The impedance of the external microphone is 2k ohms, therefore, most of electret condenser microphone can be used. A dynamic microphone should not be used.

4 EXTERNAL SPEAKER JACK

When an external speaker is preferred, plug in a 3.5mm mono plug into this jack.

The impedance of the external speaker should be 8 ohms. When an external speaker is used, the internal speaker will be disabled.

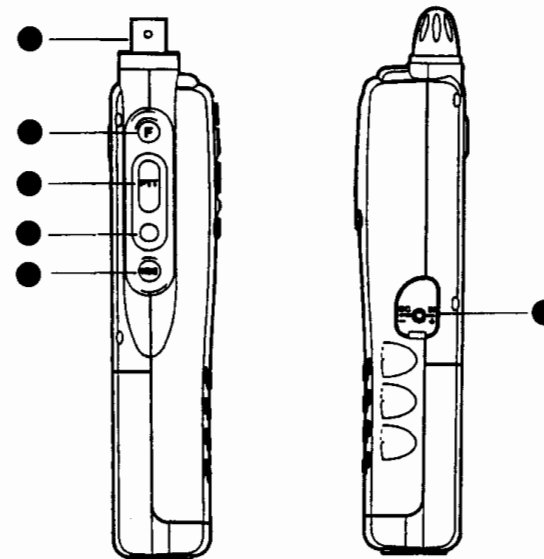

5 BNC ANTENNA CONNECTOR (Not applicable for DJ-491C)

Connect the supplied rubber duckie antenna. When an external antenna is connected, please make sure that your antenna has a low SWR (Standing Wave Ratio).

6 F (FUNCTION) KEY

Before using your transceiver, it is recommended that you thoroughly familiarize yourself with the operation of this key, as it is essential for the majority of the radio's functions.

The **F** key allows you to access the secondary functions.

You may also reset the radio by holding the **F** key as you turn on the unit. This restores the transceiver to the default settings and erases all memory channels besides other settings. (Not applicable for DJ-491C)

To transmit, press and hold this switch. When you release it, the unit will return to the receive mode.

7 PTT (PUSH TO TALK) SWITCH

8 L PTT (LOW POWER OUTPUT PTT) SWITCH (T Version)/ TONE-BURST SWITCH (E Version) (Not applicable for DJ-491C)

T Version:

When this switch is pressed, the radio will transmit with a low power output regardless the output power setting by the **LOW** key.

● **MONI (MONITOR)/BS KEY**

E Version:

When this switch is pressed, the radio will transmit with 1750Hz tone burst.

Pressing and holding this key while turning power on will toggle between low power PTT (LCD to show " Pt-L o ") and tone burst (LCD to show " Pt-t b ") functions for this switch.

This key is used to unmute squelch, and a weak or intermittent signal can be monitored regardless the squelch setting. This is also available to monitor receive frequencies when TSQ (Tone Squelch) or DSQ is set.

Press and hold this key and turn on the power to toggle BS (Battery Save) on/off.

To turn power on the unit, press and hold for about one second.

To turn power off, press again.

When the PTT switch is pressed, this LED lights red indicating that the radio is in the transmit mode.

When incoming signals are received and the squelch is unmuted, this LED lights green.

(During DSQ or TSQ, the audio remains muted unless the tones match, regardless of this RX LED.)

When this key is pressed, the LCD will be illuminated. It will automatically turn off after five seconds. To keep illuminating the LCD, press and hold this key and turn the power on; in this case, each push of the LAMP key will toggle the illumination without the timed light off.

This key is also used to change the output power setting.

To change the output power setting, press and hold the **F** key, and press this key.

When the "L" icon appears on the bottom left of the LCD, the radio is set to the low power output mode.

When the "L" icon is NOT displayed on the LCD, the radio is set to the high power output mode.

This key is used to increase the speaker output volume. While pressing and holding this key, the

● **POWER SWITCH**

● **TX LED**

● **RX LED**

● **LAMP (H/L) KEY**

● **UPWARD KEY**

● **DOWNWARD KEY**

● **DTMF KEYPAD**

● **MIC**

● **DC JACK**

"VOL" icon will appear on the top middle of the LCD indicating that the volume level is setting.

To change the squelch level, press and hold the **F** key, and press this key.

The "SQL" icon will appear on the LCD indicating that the squelch level is setting.

When the squelch level is set higher, only stronger signals will be unmuted.

This key is used to decrease the speaker output volume. While pressing and holding this key, the "VOL" icon will appear on the top middle of the LCD indicating that the volume level is setting.

To change the squelch level, press and hold the **F** key, and press this key.

The "SQL" icon will appear on the LCD indicating that squelch level is setting.

When the squelch level is set lower, weak signals can be unmuted.

During transmission, each numerical or letter key activates one DTMF tone. Press in desired order.

The speaker will emit the DTMF tone to let you monitor successful key activation.

During receiving mode, the number keys will input frequency, and *, #, A, B, C, D keys have their respective functions as inprinted in grey colour on the key panel; when pressed while pressing the **F** key, secondary functions inprinted in green become their respective functions. Invalid entries will be responded in a low-tone beep instead of high-tone beep.

See DTMF KEYPAD OPERATION (Section 7-2) Chart for the details.

Speak into the microphone from approximately 10cm or 3" distance.

Plug in the optional EDC-36 cigarette lighter adapter with active noise filter for mobile operation. The jack is polarized, the center pin is positive and outer pin is negative. Applying excessive or reverse voltage will cause severe damages and will void the radio's warranty.

7-2 DTMF Keypad Operation

KEY	Without pressing the F key	While pressing the F key
STEP 1 ①	Inputs 1	Channel Step setting (page 19)
SHIFT 2 ②	Inputs 2	Shift (offset) frequency setting (page 7)
TOT 3 ③	Inputs 3	Time Out Timer setting (page 23)
T SQL 4 ④	Inputs 4	Tone Encode/Tone Squelch setting (page 7)
⑤	Inputs 5	N/A
⑥	Inputs 6	N/A
⑦	Inputs 7	Change DTMF emission delay time (page 11)
⑧	Inputs 8	N/A
⑨	Inputs 9	N/A
⑩	Inputs 0	N/A
V/M MW A ⑪	Toggles between the VFO mode and Memory mode (page 21)	Memory Write (page 8)
SCAN KL/FL B ⑫	Start/Stop scanning (page 22)	Key Lock/Frequency Lock (page 22)
CALL APO C ⑬	Access the call channel (page 9)	Automatic Power Off setting (page 23)
AUTO DIAL D SKIP ⑭	Operating the auto dialer (page 10)	Memory channel Skip setting (page 9)
▲ DSQ # ⑮	Increments frequency/memory ch.	DSQ code setting (page 11)
▼ DIAL M * ⑯	Decrements frequency/memory ch.	Auto dialer setting (page 10)

7-3 LCD Display

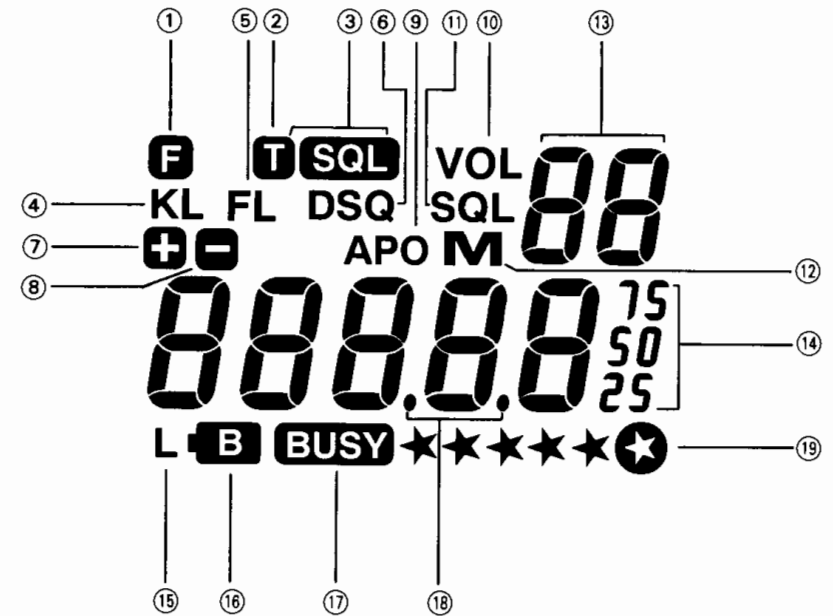

- ① **F** When the **F** icon appears, secondary function keys may be activated.
- ② **T** It appears when the tone encoder is activated.
- ③ **T SQL** It appears when the tone squelch is activated.
- ④ **KL** The "KL" icon appears when the Key Lock is activated.
- ⑤ **FL** The "FL" icon appears when the Frequency Lock is activated.
- ⑥ **DSQ** It appears during DSQ operation.
- ⑦ **+** It indicates the plus offset direction. That is, your transmit frequency will be higher than the receiving frequency by the offset-frequency amount.
- ⑧ **-** It indicates the minus offset direction. That is, your transmit frequency will be lower than the receiving frequency by the offset-frequency amount.
- ⑨ **APO** It appears when the APO (Automatic Power Off) function is activated.

- ⑩ **VOL** It appears while the volume level is being adjusted by either the upward key or downward key.
- ⑪ **SQL** It appears while the squelch level is being adjusted by pressing the **F** key and either the upward key or downward key.
- ⑫ **M** In the Memory Mode, the "M" icon appears.
In the VFO Mode, the "M" icon is not displayed.
- ⑬ **BB** While either the volume level or squelch level is adjusted, some numbers will appear indicating the setting levels (min. 0 ~ max. 31).
In the Memory Mode, it indicates the selected memory channel number (0 ~ 39, or "C" for call channel).
- ⑭ **8888.88** It indicates the transmit/receive frequency, offset frequency, tone frequency, tuning step, DSQ code and AUTO DIAL code.
- ⑮ **L** When the low power output is selected, the "L" icon appears.
When the "L" icon is not displayed, the high power output is selected. (Not applicable for DJ-491C)
- ⑯ **B** When the voltage of the battery is dropped and need to be recharged, the "B" icon appears.
If it is displayed, turn off the power and recharge the battery. It will take approximately 12 to 14 hours to be fully charged with EDC-63 or EDC-64.
- ⑰ **BUSY** The "BUSY" icon will appear when a signal is received, or squelch is unmuted.
(During DSQ or TSQ, the audio remains muted unless the tones match, regardless of the "BUSY" icon.)
- ⑱ **. (decimal point)** It indicates: MHz for transmit/receive and offset frequencies.
kHz for channel step.
Hz for encoded sub-audible tone (CTCSS) tone frequency.
In the Scan Mode, the decimal point flashes.
- ⑲ **★★★★★** It indicates the received signal strength and/or the output power level.

8. GETTING STARTED

8-1 Receiving

1. Adjust the following and controls of the unit.
POWER SWITCH: OFF
VOLUME CONTROL: Set to "0" level
SQUELCH CONTROL: Set to "0" level
2. Connect a battery pack or external 4.8 ~ 13.8 Volt DC Regulated Power Supply to the radio.
3. Ensure an antenna with the appropriate antenna connector is connected.
4. Turn the POWER switch on.
5. Press the upward key until a signal (or noise) is heard through the speaker.
6. The LCD display will indicate frequency.
7. Rotate the Main Tuning Dial, or enter the frequency from the DTMF keypad to select a frequency. Press and hold the **F** key, then press the upward key until the noise disappears from the speaker.

KEYPAD DIRECT ENTRY

When a frequency is selected by the direct keypad entry, numbers will appear on the LCD display as they are entered through each push of a key.

To enter a frequency directly from the keypad, perform the following.

The following example will use frequency 146.52MHz, and step of 5kHz.

1. Enter the 100MHz digit first. Example: 1__ .__ |
2. Enter the 10MHz digit next. Example: 14__ .__ |4
3. Enter the 1MHz digit next. Example: 146__ .__ |46
4. Enter the 100kHz digit next. Example: 146.5__ |46.5
5. Enter the 10kHz digit next. Example: 146.52__ |46.52
6. Enter the 1kHz digit next. Example: 146.520

STEP KEY

The STEP function is used to select the desired incremental changes of receive/transmit frequencies, in step of 5, 10, 12.5, 15, 20, 25, 30kHz. Use this feature as follows:

1. Enter the VFO MODE.
2. Press and hold the **F** key, then press the **STEP** key.
Change the channel step by using the Main Tuning Dial.
3. Press the PTT switch to return to the operating frequency.
4. After the channel step is set, the receive/transmit frequency will increase or decrease by the value selected when you turn the Main Tuning Dial.

Note: The following rules apply to channel steps as indicated.

1. When 5kHz channel step is selected, keys "0" and "5" are available for entry into the 1kHz digit. (Last digit entry other than "0" or "5" will be taken as "0".)
2. When 10kHz channel step is selected, keys "0", "1", "2", "3", "4", "5", "6", "7", "8" and "9" are available for entry into the 10kHz digit.
3. When 12.5kHz channel step is selected, keys "0", "1", "2", "3", "5", "6", "7" and "8" are available for entry into the 10kHz digit.
4. When 15kHz channel step is selected, keys "0", and "5" are available for entry into the 1kHz digit. (Last digit entry other than "0" or "5" will be taken as "0".)
5. When 20kHz channel step is selected, keys "0", "1", "2", "3", "4", "5", "6", "7", "8", "9" and "0" are available for entry into the 10kHz digit.
6. When 25kHz channel step is selected, keys "0", "2", "5" and "7" are available for entry into the 10kHz digit.
7. When 30kHz channel step is selected, keys "0", "1", "2", "3", "4", "5", "6", "7", "8", "9" and "0" are available for entry into the 10kHz digit.

CHANGING FREQUENCY IN ONE MHz STEPS

In the VFO Mode, pressing and holding the **F** key, rotate the Main Tuning Dial. This will change the frequency Up or Down in one MHz Steps.

CLEARING ENTRY

To clear an error during keypad entry, you may press the PTT switch to exit and start over again.

8-2 Transmitting

Cautions: *Ensure that you always use the original rubber duckie antenna or an external antenna with low SWR (Standing Wave Ratio) readings. Improper antenna connection may cause damage to the radio and may void warranty.*

1. Make sure that you follow all steps set forth in the "6. GETTING STARTED" section first.
2. Select a frequency, shift direction, shift value and CTCSS Tone (Sub-Audible Tone) frequency.
3. Check to see that the frequency is not in use before transmitting.
4. Select appropriate transmitter output level.
5. Press and hold the PTT switch and speak approximately 10cm or 3" from the microphone located on the front bottom of the radio.

8-3 Transceiver Modes

Your transceiver has 3 modes; VFO mode, MEMORY mode and CALL mode.

VFO (Variable Frequency Oscillator) MODE

The transceiver will be in the VFO mode. This mode is used to change frequency and select the desired channel step, offset frequency shift direction, tone frequency (encoder and decoder), tone setting, DSQ code, DSQ setting, Power H/L, and BS (battery save ON/OFF).

MEMORY MODE

The following guidelines will help you to program and manipulate memory channels. In the Memory mode, memory channels can be reviewed. To select the Memory mode, press the **A** key.

PROGRAMMING A MEMORY CHANNEL

To write VFO informations into a memory channel, perform the followings.

1. Enter the MEMORY MODE.
2. Rotate the Main Tuning Dial to choose the desired memory channel number (clockwise to increase, counter-clockwise to decrease). Select the desired memory channel number (0 to 39).
3. If the Memory Channel Number is flashing, it indicates the memory channel is vacant. A non-vacant channel can be over-written with new data.
4. Enter the VFO mode.
5. Select the receive frequency.
6. Select the shift **-** or **+**, or none.
7. Select the required offset (Consult your Repeater Directory) if shift is required.
8. Select the proper CTCSS Tone (Sub-Audible Tone) if needed.
9. Select the Tone Squelch if needed (An optional Tone unit (EJ-28U) is required).
10. Other data, such as DSQ code, DSQ activation, Power H/L, and BS (battery save OFF/ON) may be set, if so desired to memorize into the channel.
11. Press and hold the **F** key, and press the **A** key to write (store) the information to the memory.

SCROLL MEMORY

Scrolling memory channels up or down can be accomplished as followings;

1. Select the MEMORY MODE. The memory channel number (0-39) will appear.
2. Turn the Main Tuning Dial to increase or decrease the memory channel.

SCAN/SKIP

You can scan the memory channels with the  key.

Select to skip any memory channel in scan, by pressing and holding **F** key and pressing the  key (frequency's decimal point disappears).

8-4 Other Functions

BATTERY SAVE FUNCTION (BS)

The battery save function helps conserve battery power. When no operation is performed and no signal is received for 5 seconds, the battery save function will activate automatically.

The factory's default setting of the battery save function is ON.

To deactivate this function, press and hold the **MONI** key while pressing and holding the power switch. The "b5 - OF" icon will be displayed on the LCD indicating that the battery save function is disabled.

Repeating above steps will re-activate the battery save function.

(Note: Regardless of the above, the battery save function is temporarily disabled during the DSQ MODE or Scanning mode.)



BEEP ON/OFF

Press and hold the  key while turning on the power switch. This will toggle between beep sound on and off.

KL (KEY LOCK)

This function conveniently locks keys to prevent accidental function access.



Only following controls are available during the activation of the KL function.

1. Main Tuning Dial
2. **PTT** switch
3. **LOW PTT** switch (T Version)/
"Tone Burst" switch (E Version)
4.  key
5. **MONI** key
6.  key (VOL/SQL)
7.  key (VOL/SQL)

FL (FREQUENCY LOCK)

This function conveniently locks keys to prevent accidental frequency changes, function access.

Only following controls are available during the activation of the FL function.

1. **PTT** switch
2. **LOW PTT** switch (T Version)/
"Tone Burst" switch (E Version)
3.  key
4. **MONI** key
5.  key (VOL/SQL)
6.  key (VOL/SQL)

APO (AUTOMATIC POWER OFF)

The APO function automatically turns the transceiver power off if no switches or controls are operated, for 30 minutes. This function protects against battery drainage when you forget to turn the power off.

To activate the APO function, perform the followings:

1. Press and hold the **F** key, then press the  key.
The "APO" icon will appear on the LCD.
2. While the "APO" icon appears, if no operation is performed for 30 minutes, an OFF of Morse Code is automatically heard.
3. At the end of Morse Code, the transceiver power is automatically turned off.

CTCSS TONE FREQUENCIES

There are 50 different tone frequencies available for tone encode. Decoder EJ-28U is available as an option.



Following is the list of those frequencies: (Hz)

67.0	69.3	71.9	74.4	77.0	79.7	82.5	85.4	88.5	91.5
94.8	97.4	100.0	103.5	107.2	110.9	114.8	118.8	123.0	127.3
131.8	136.5	141.3	146.2	151.4	156.7	159.8	162.2	165.5	167.9
171.3	173.8	177.3	179.9	183.5	186.2	189.9	192.8	196.6	199.5
203.5	206.5	210.7	218.1	225.7	229.1	233.6	241.8	250.3	254.1

T.O.T. (Time-Out-Timer)

A time-out-timer automatically shuts down transmission and resumes receiving after a set period of continuous transmit time.

To protect the radio from excessive transmit, a Time Out Timer has been installed. This can be programmed to activate from 0 seconds to 450 seconds (7.5 Minutes).

Press and hold the **F** key and press the  to select the TOT programming mode; the LCD will display the selected Time Out Time in seconds. Use the Main Tuning Dial to change the Time Out setting. Push the  key or PTT to exit.
(Refer to page 29 "Appendix" for T.O.T-Penalty Time function.)

CABLE CLONING (for all versions except DJ-491C)

With an interface cable (see following diagram), cloning is possible with your Alinco transceiver. This means that the entire memory and VFO contents of one transceiver will be transferred to another transceiver via the interface cable.

Here is how it works:

1. Turn power off on both radios.
2. Plug-in one end of the interface cable into the speaker jack of one radio, and plug-in the other end into the speaker jack of the other radio.
3. Turn on the power on both radios.

4. Press and hold the **MONI** key, then press the **PTT** switch **three times** on both radios.
The "*CLonE*" icon will appear on the LCD of both radios.
5. Press the **MONI** key of the radio receiving the information to be copied (SLAVE RADIO).
The "*rEAdY*" icon will appear on the LCD.
6. Press the **PTT** switch of the radio (MASTER RADIO) whose memory will be transferred to the slave radio.
The "*PUSh*" icon will appear on the LCD. Press the **PTT** switch again on the master radio to start transfer of information data.
7. During the cloning, the "*SEnd*" icon will appear on the LCD of the master radio, and the "*GEt*" icon will appear on the LCD of slave radio. After the cloning, the "*End*" icon will appear for two seconds on the LCD of slave radio.
8. Turn the power off on both radios.
9. Disconnect the interface cable.
Clone interface cable should be built as follows:

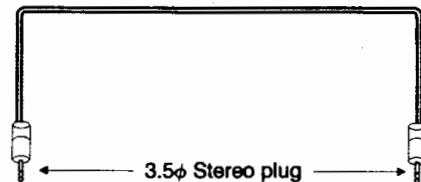

MASTER

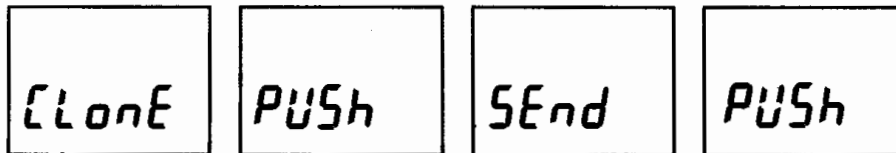

SLAVE

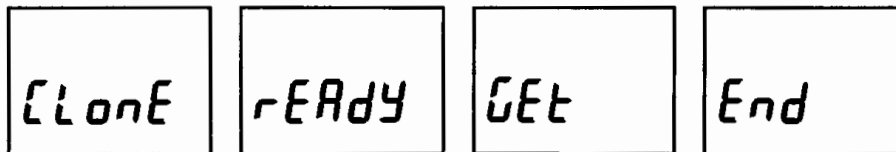

8-5 Resetting (Not applicable for DJ-491C)

While pressing the **F** key, turn on power.

	DJ-191T/TA1/TA2	DJ-191E	DJ-491TA1/TA2/TA3
VFO Frequency	145.000MHz	145.000MHz	445.000MHz
Channel Step	5kHz	12.5kHz	5kHz
Shift	None	None	None
Offset Frequency	0.6kHz	0.6kHz	0.6kHz
Call Frequency	145.000MHz	145.000MHz	445.000MHz
DSQ Setting	None	None	None
DSQ Code	None	None	None
Auto Dialer Code	None	None	None
Tone Setting	None	None	None
Tone Frequency	88.5Hz	88.5Hz	88.5Hz
Transmitter Output	Low	Low	Low
Key Lock	Off	Off	Off
Time Out Timer	Off	Off	Off
Low Power/Tone Burst	Low PTT	Tone Burst	Low PTT
Battery Save function	On	On	On
DTMF pause before first digit	0.4	0.4	0.4

8-6 CTCSS Decoder Unit EJ-28U Installation

As per diagram on the right, install the EJ-28U by mating the connectors.

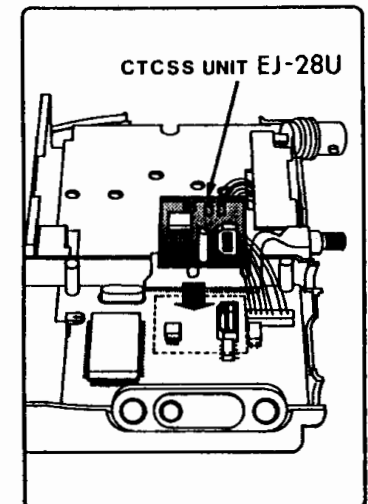

● Charger EDC-63 (for 120VAC), EDC-64 (for 220VAC)

This unit is a Charger for exclusive use of Ni-Cd Battery Packs used with the ALINCO handheld transceiver.

With EDC-63/EDC-64, the battery packs EBP-33N/EBP-34N can be charged while it is attached to the transceiver or the receiver.

< Installation >

Insert the battery-pack fully into the charger unit, matching the grooves. The red lamp will light up and charging will start.



EBP-33N
EBP-34N
EBP-35N
EBP-36N
EBP-37N

EDC-63/64

Caution

1. Turn off the transceiver power while charging.
2. Never charge the battery packs of other makes with this Charger.
3. The required charging time depends on the conditions and the models of battery pack. Refer to the instruction manuals of the battery pack.
4. Never short-circuit the charging terminals of this Charger with a metal object, etc. for the charger may be damaged by a strong current.
5. Precaution
Don't insert the above mentioned Ni-Cd batteries viceversa.
This mis-use causes damage on the drop in charger.
6. Never mount the battery pack in the charger backwards.
7. Charging should be conducted in the temperature range of 0°C to 40°C as incomplete charging or deterioration of battery performance may occur if charged outside this range.

● Ni-Cd Battery EBP-33N/34N/35N/36N/37N

Note

1. The battery pack is not charged when shipped. It must be charged before using.
2. Charging should be conducted in the temperature range of 0°C to 40°C, as incomplete charging or deterioration of battery performance may occur if charged outside this range.
3. Do not modify, dismantle, incinerate or immerse the battery pack in water as this may be dangerous. Be careful not to drop the battery pack or subject it to any severe shocks.

4. Never short-circuit the battery pack terminals, as this may cause damage to the equipment or lead to heating of the battery which may cause burns.
5. Unnecessarily prolonged charging (overcharging) may result in deterioration of battery performance.
6. The battery pack should be stored in a dry place with a temperature range of -20°C to +45°C. Temperatures outside this range or extremely high levels of humidity may lead to leaking of the battery liquid or resting of the metal components of the batteries.
7. Normally the battery pack can be charged up to 300 times. However, the battery pack can be considered to be exhausted if the period of use drops off markedly despite being charged for the aforementioned time. When this happens, a new pack should be used.
8.  ATTENTION: The battery that you have purchased is recyclable. At the end of its useful life, under various state and local laws, it may be illegal to dispose of this battery into the municipal waste stream. Check with your local solid waste officials for details in your area for recycling options or proper disposal.

Charging with EDC-63 or EDC-64 (Normal Charger)

1. Mount the Ni-Cd battery pack in the charger. The red lamp will light up and charging will start.
2. See table 2 for charging time. Dismount the battery pack from the charger after the charging.

Charging with EDC-60 or EDC-61 (Quick Charger)

1. Mount the Ni-Cd battery pack in the charger. The red lamp will light up and charging will start.
2. When the battery pack is mounted correctly, the red lamp will light up and quick charging will start.
When quick charging is completed, the red lamp will go off/the green lamp will light up. The charge rate will be then reduced to a weak supplementary charge rate to protect the battery pack from overcharging.

Specifications

	BATTERY CAPACITY	OUTPUT VOLTAGE
EBP-33N	650mAH	4.8V
EBP-34N	1200mAH	4.8V
EBP-35N	900mAH	7.2V
EBP-36N	650mAH	9.6V
EBP-37N	700mAH	4.8V

Charging Times and Chargers

	EDC-63 (for 120V) EDC-64 (for 220V)	EDC-60 (for 120V) EDC-61 (for 220V)
EBP-33N	Approx. 10 hours	Approx. 0.7 hour
EBP-34N	Approx. 18 hours	Approx. 1.2 hours
EBP-35N	Approx. 10 hours	Approx. 1.7 hours
EBP-36N	Approx. 10 hours	Approx. 1.2 hours
EBP-37N	Approx. 11 hours	Approx. 0.7 hour

The above times are required for completely discharged battery pack.

ATTENTION !

PREVENT SHORT-CIRCUITING OF THE NI-Cd BATTERY PACK

Be extra cautious when carrying the Ni-Cd battery pack; short-circuiting will produce surge current flow resulting in possible fire.

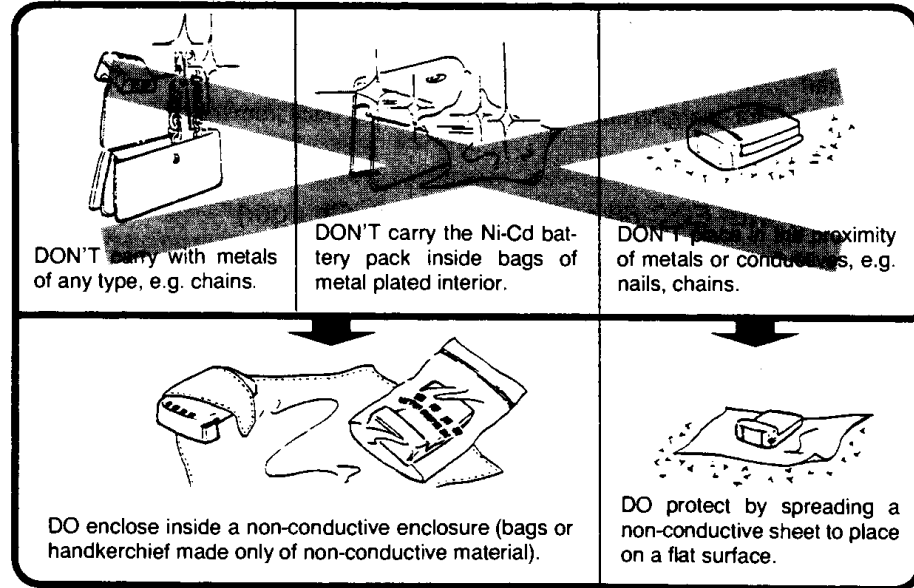
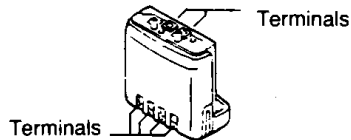

*For Carrying The battery pack, it should be kept in the bag provided.

● # 824 Functions

The Transceiver supports the following # 824 functions.

BCLO (busy channel lock out): Enables or disables the busy channel lock out.

Default setting: Disabled.

ANS (answer-back): Enables or disables the answer-back.

Default setting: Disabled.

BPT (burst/pause time): Sets the DTMF burst/pause time.

Default setting: 60 msec.

BST (burst time): Sets the burst time for the first digit of the DTMF code.

Default setting: 60 msec.

TOT-P (TOT penalty time): Sets the penalty time.

Default setting: 5 sec.

Starting and Exiting the # 824-Function Mode

To enter the # 824-function mode:

1. Hold down the **F** key and press the **SCAN/HL/PL** key until either "KL" or "FL" is displayed.
2. Enter the password "# 824" with the numeric keys. When you enter the correct password, "oPEn" will appear for a few seconds.
3. Activate the desired function by holding down the **F** key and pressing the appropriate numeric key. See the following table.

To activate:	Press:
BCLO (busy channel lock out)	F + 5
ANS (answer-back)	F + 6
BPT (burst/pause time)	F + 8
BST (burst time)	F + 9
TOT-P (TOT penalty time)	F + 0

For more information about these functions, see the following sections.

To exit the # 824-function mode:

1. Hold down the **F** key and press the **SCAN/HL/PL** key until either "KL" or "FL" is displayed.
2. Enter the password "# 824" with the numeric keys. When you enter the correct password, "CLoSE" will appear for a few seconds, indicating that you can no longer use the # 824 functions.

BCLO (Busy Channel Lock Out)

Turning on the BCLO disables transmission, except when:

- No signal is received ("BUSY" disappears).
- The tone matches and the squelch is unmuted (while using tone squelch* only).
- The code matches and the squelch is unmuted (while using code squelch only).
- Both the tone and code match and the squelch is unmuted (while using the code and tone squelch*).

If you press the PTT key in the BCLO mode, you will hear a warning beep and "BUSY" will blink once, instead of the transceiver transmitting data.

*optional EJ-28U required.

To enable or disable the BCLO:

1. In the #824-function mode, hold down the **F** key and press the **6** key.
The current BCLO status appears.
2. Turn the Main Tuning Dial to select the desired value.
L0-0F The BCLO is disabled (default).
L0-0n The BCLO is enabled.
3. Press the PTT or **A** key. Or hold down the **F** key and press the **6** key.

ANS (Answer-Back)

To work with the answer-back, you must previously program the DSQ. When the DSQ code matches and the squelch is unmuted, the transceiver automatically sends a single 852 Hz, 10 second tone. The answer-back is activated even when the transceiver is in the BUSY status (the squelch has been unmuted).

To enable or disable the ANS:

1. In the #824-function mode, hold down the **F** key and press the **6** key.
The current answer-back setting is displayed.
2. Turn the Main Tuning Dial to select the desired value.
Rn-0F The answer-back is disabled (default).
Rn-0n The answer-back is enabled.
3. Press the PTT or **A** key. Or hold down the **F** key and press the **6** key.

BPT (Burst/Pause Time)

The auto dialer and DSQ uses the time you specify here as the burst and pause durations for the DTMF code. Note that you cannot change the burst/pause time in the Channel Indication mode.

To set the BPT:

1. In the #824-function mode, hold down the **F** key and press the **6** key.
The current burst/pause time appears.

2. Turn the Main Tuning Dial to select the desired value.

Display	Burst time	Pause time
P-60	60 msec.	60 msec. (Default)
P-80	80 msec.	80 msec.
P-160	160 msec.	160 msec.
P-200	200 msec.	200 msec.

3. Press the PTT or **A** key. Or hold down the **F** key and press the **6** key.

BST (Burst Time)

Sets the burst duration for the first digit of the DTMF code. The auto dialer and DSQ use the time you specify here as the burst duration for the first digit of the DTMF code. Note that you cannot change the burst time in the Channel Indication mode.

To set the BST:

1. In the #824-function mode, hold down the **F** key and press the **6** key. The current burst/pause time appears.

2. Turn the Main Tuning Dial to select the desired value.

Display	1st digit burst time
b-60	60 msec. (Default)
b-80	80 msec.
b-160	160 msec.
b-200	200 msec.

3. Press the PTT or **A** key. Or hold down the **F** key and press the **6** key.

TOT-P (TOT Penalty Time)

If the TOT (Time Out Timer) expires, the transmission is prohibited until the TOT penalty time you specify elapses. If you press the PTT key during the penalty time, you will hear an alarm beep. However, if you are still holding down the PTT key after the TOT expires, the penalty will be cancelled just after the TOT penalty time elapses.

To set the TOT-P:

1. In the #824-function mode, hold down the **F** key and press the **6** key.
The current penalty time appears.

2. Turn the Main Tuning Dial to select the desired value. The range is from 0 to 15 seconds, and the default is 5 seconds. For example, when the LCD displays:

tP-05 the penalty time is set to 5 seconds.

3. Press the PTT or **A** key. Or hold down the **F** key and press the **6** key.