

FT-411

TECHNICAL SUPPLEMENT



MANUALE DI SERV. X
FT-411

05910801



2 005910 801004

YAESU MUSEN CO., LTD.

C.P.O. BOX 1500, TOKYO, JAPAN

YAESU U.S.A.

17210 Edwards Rd., Cerritos, California 90701, U.S.A.

YAESU EUROPE B.V.

Snipweg 3. 1118AA Schiphol, The Netherlands

This manual is intended to serve as a supplement to the FT-411 Operating Manual. Specifications and details of operation and options are provided in the Operating Manual, and are not reprinted herein. Therefore, this manual is not intended to serve as an independent reference, but to be used in conjunction with the information provided in the Operating Manual.

Two layout diagrams are provided for each double-sided glass-epoxy circuit board in the FT-411. Each side of the board is identified by the type of the majority of components installed on that side. In most cases one side has only chip components, and the other has either a mixture of both chip and lead components (trimmers, coils, electrolytic capacitors, packaged ICs, etc.), or leaded components only.

While we believe the technical information in this manual is correct, Yaesu assumes no liability for damage that may occur as a result of typographical or other errors that may be present. Your cooperation in pointing out any inconsistencies in the technical information would be appreciated.

Yaesu Musen reserves the right to make changes in the circuitry of this transceiver, in the interest of technological improvement, without notification of the owners.

CONTENTS

CIRCUIT BOARD ACCESS	1
EXPLODED VIEW	2
MOTHER BOARD UNIT PARTS LAYOUT	3
MOTHER BOARD UNIT CIRCUIT DIAGRAM	5
MOTHER BOARD UNIT PARTS LIST	6
IF UNIT PARTS LAYOUT/CIRCUIT DIAGRAM	9
IF UNIT PARTS LIST	10
REG UNIT PARTS LAYOUT/CIRCUIT DIAGRAM	11
REG UNIT PARTS LIST	12
ANT SW UNIT PARTS LAYOUT/CIRCUIT DIAGRAM	13
ANT SW UNIT PARTS LIST	14
PLL,CLOCK UNIT PARTS LAYOUT/CIRCUIT DIAGRAM	15
PLL,CLOCK UNIT PARTS LIST	16
CONTROL UNIT PARTS LAYOUT	18
CONTROL UNIT CIRCUIT DIAGRAM	20
CONTROL UNIT PARTS LIST	21
SW UNIT A & B	24
T-BURST UNIT	25
FTS-17 PARTS LAYOUT/CIRCUIT DIAGRAM (OPTION)	26
FTS-17 PARTS LIST	27
BLOCK DIAGRAM	28
CONNECTION DIAGRAM	29
ALIGNMENT	30
ALIGNMENT (PLL & Transmitter)	31
ALIGNMENT (Receiver)	32

CIRCUIT BOARD ACCESS

- 1) Make sure the transceiver is off. Remove the hard or soft case, if used, and remove the battery pack. Also remove the antenna.
- 2) Remove the four screws affixing the battery spring plate on the bottom of the transceiver, and carefully remove the plate and the battery catch button.
- 3) Pull off the three knobs on the top panel. Then remove the five screws affixing the panel and carefully remove it and the rubber gasket underneath.
- 4) Remove the two screws affixing the front and rear halves of the case, and slowly separate the halves, using care not to stress the inter-connecting cable.

To separate the front and rear halves of the chassis, use a small screwdriver to pry up one side of the plug on the "rear panel end" of the flat cable (see upper inset in diagram below), and then gently pull the plug out of its jack.

To remove the Control Unit from the front half of the chassis, remove the five screws indicated in the diagram, and unsolder the shield plate (2 places) and the loudspeaker wires (2 places).

To remove the Mother Board Unit from the rear half of the chassis, unsolder the ANT jack from the Mother Board (2 places, see lower inset), and then remove the five screws shown.

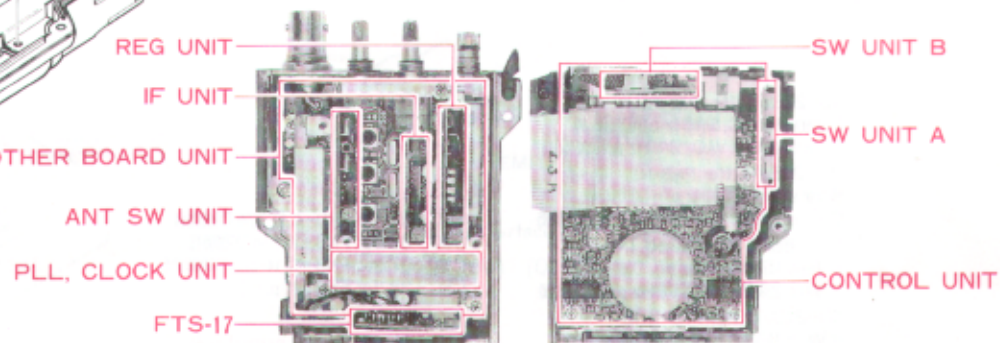
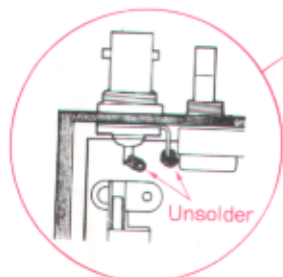
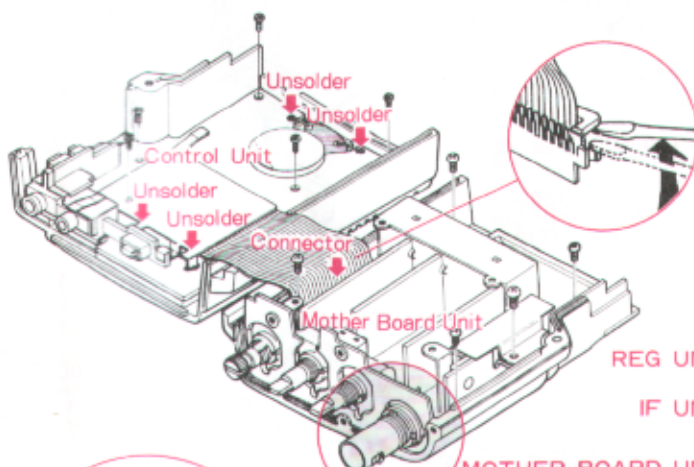
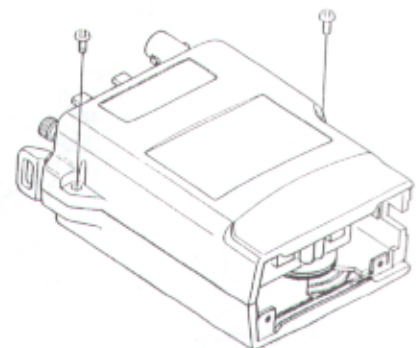
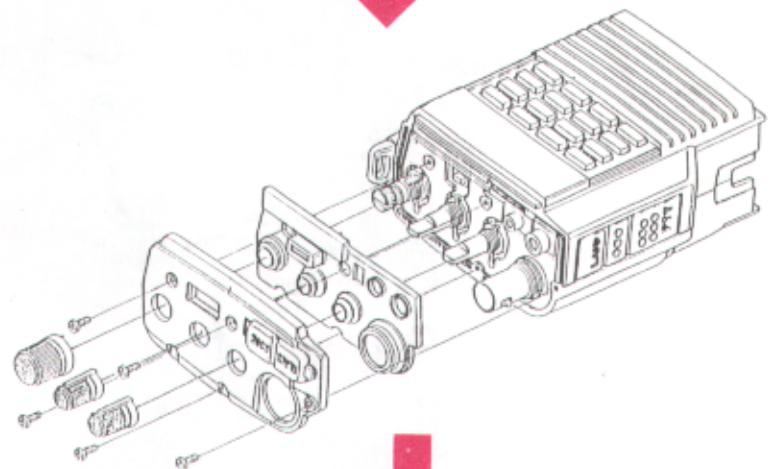
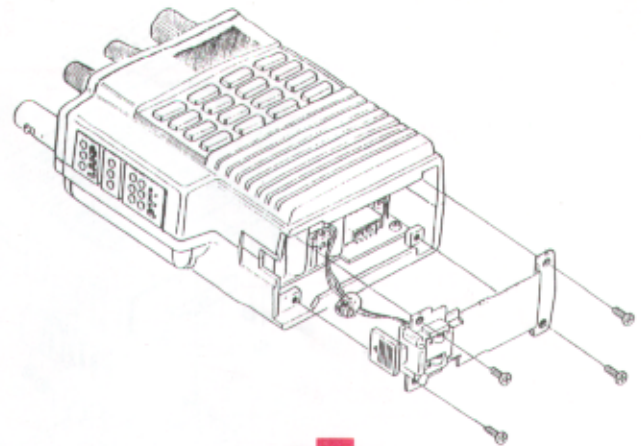

BOARD LOCATIONS

EXPLODED VIEW

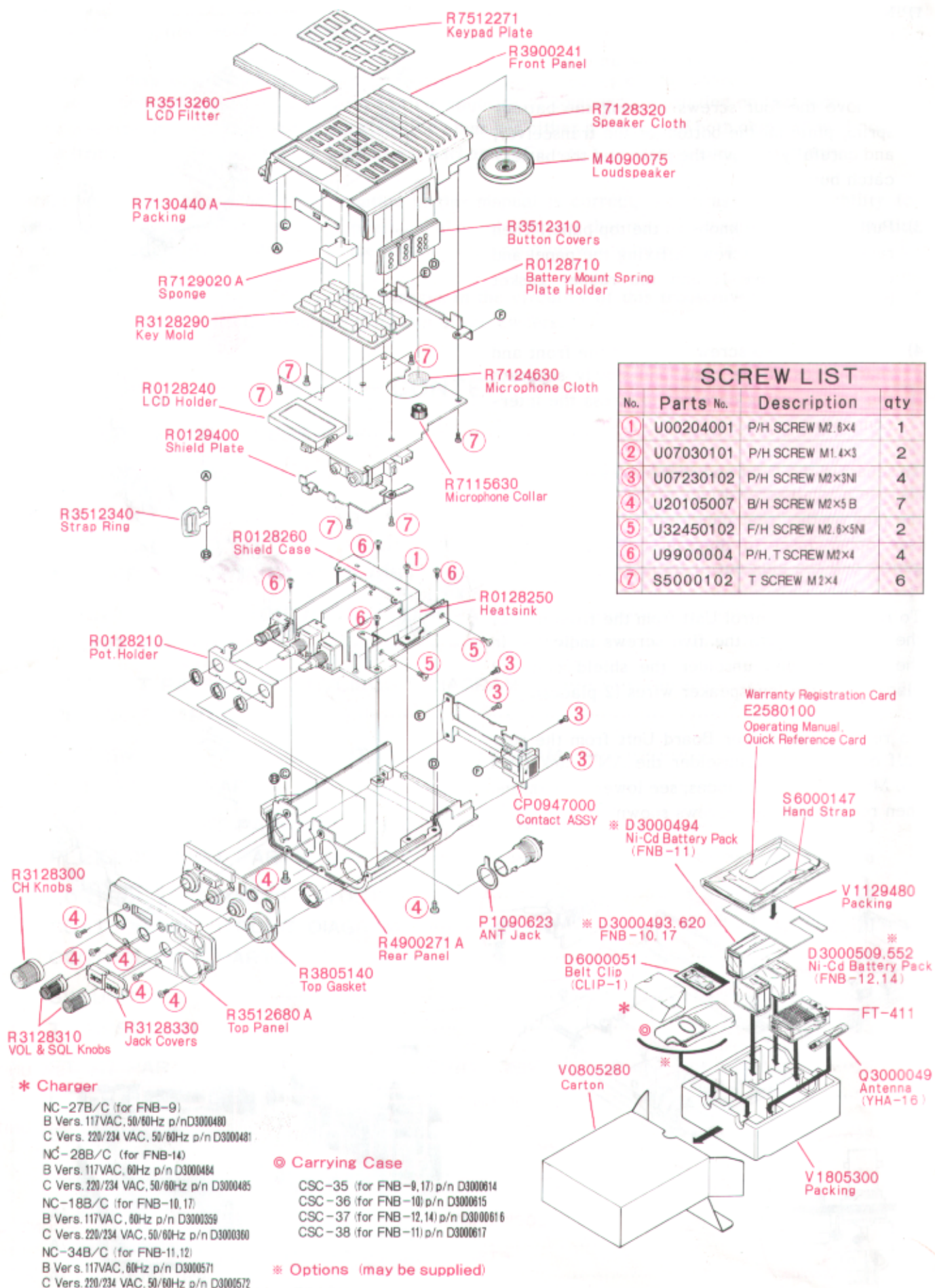

SCREW LIST			
No.	Parts No.	Description	Qty
①	U00204001	P/H SCREW M2.6x4	1
②	U07030101	P/H SCREW M1.4x3	2
③	U07230102	P/H SCREW M2x3NI	4
④	U20105007	B/H SCREW M2x5 B	7
⑤	U32450102	F/H SCREW M2.6x5NI	2
⑥	U9900004	P/H, T SCREW M2x4	4
⑦	S5000102	T SCREW M1x4	6

*** Charger**

- NC-27B/C (for FNB-9)
- B Vers. 117VAC, 50/60Hz p/n D3000480
- C Vers. 220/234 VAC, 50/60Hz p/n D3000481
- NC-28B/C (for FNB-14)
- B Vers. 117VAC, 60Hz p/n D3000484
- C Vers. 220/234 VAC, 50/60Hz p/n D3000485
- NC-18B/C (for FNB-10, 17)
- B Vers. 117VAC, 60Hz p/n D3000359
- C Vers. 220/234 VAC, 50/60Hz p/n D3000360
- NC-34B/C (for FNB-11, 12)
- B Vers. 117VAC, 60Hz p/n D3000571
- C Vers. 220/234 VAC, 50/60Hz p/n D3000572

◎ Carrying Case

- CSC-35 (for FNB-9, 17) p/n D3000614
- CSC-36 (for FNB-10) p/n D3000615
- CSC-37 (for FNB-12, 14) p/n D3000616
- CSC-38 (for FNB-11) p/n D3000617

*** Options (may be supplied)**

- Warranty Registration Card
- E2580100
- Operating Manual
- Quick Reference Card
- S6000147 Hand Strap
- V1129480 Packing
- * D3000494 Ni-Cd Battery Pack (FNB-11)
- * D3000493, 620 FNB-10, 17
- D6000051 Belt Clip (CLIP-1)
- * D3000509, 552 Ni-Cd Battery Pack (FNB-12, 14)
- FT-411
- Q3000049 Antenna (YHA-16)
- V1805300 Packing
- V0805280 Carton

MOTHER BOARD UNIT PARTS LAYOUT

MOTHER BOARD UNIT (No. 1 XX)

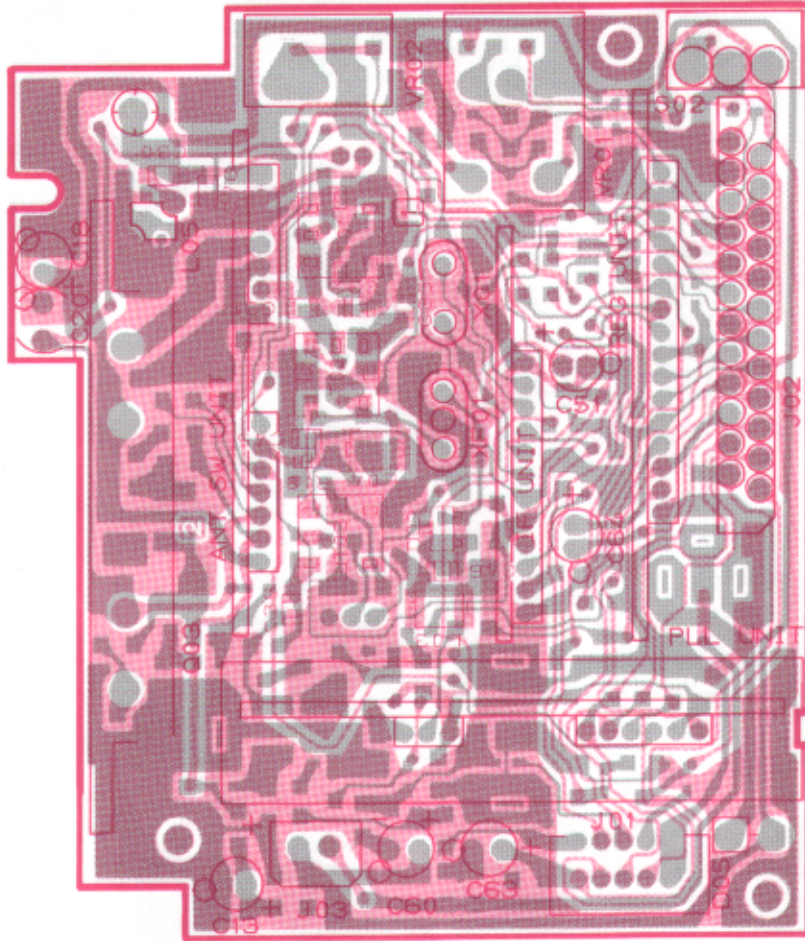

obverse view of "component" side

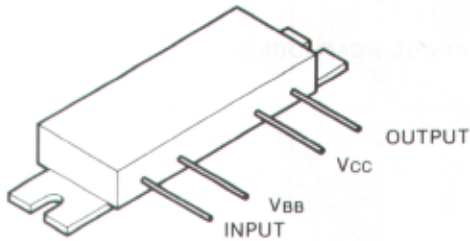

M57796MA (Q103)

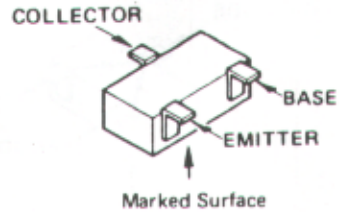

- | | | |
|----------------|---------------|------------|
| 2SC2712GR (LG) | DTA124EK (15) | (Q110) |
| (Q106,112,113) | DTC124TK (05) | (Q109) |
| 2SC2714Y (QY) | DTC144EK (26) | (Q104,105) |
| (Q101,107) | | |
| 2SC3120 (HB) | (Q108) | |

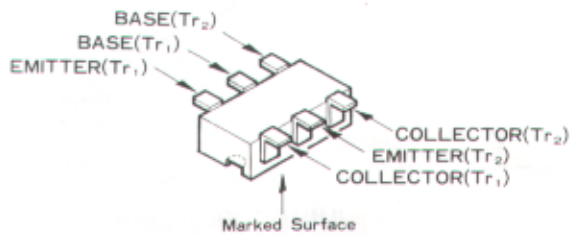

IMX5 (X5) (Q111)

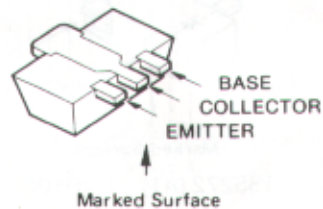

2SC2954 (0K) (Q102)

MOTHER BOARD UNIT PARTS LAYOUT

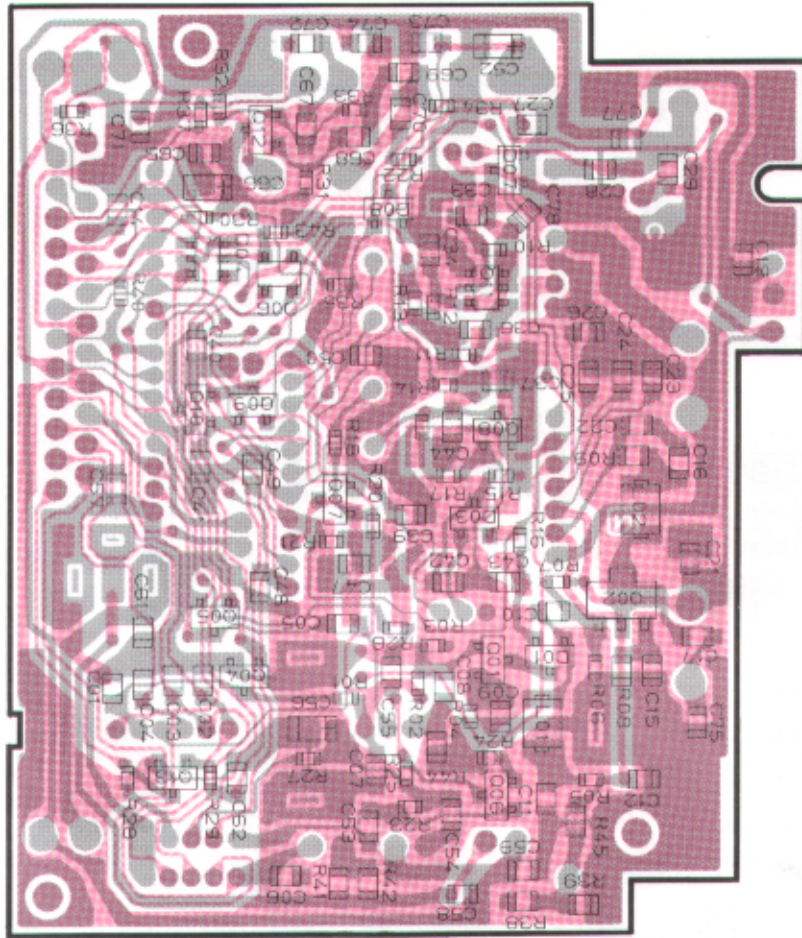

obverse view of "chip-only" side

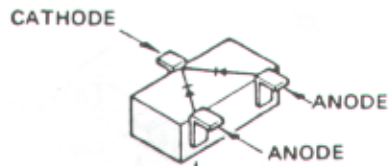

Marked Surface

1SS184 (B3) (D101,103)

ANODE 1/CATHODE 2



Marked Surface

1SS226 (C3)
(D101,107,108)

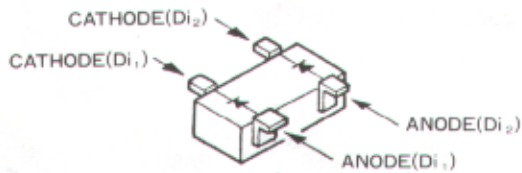

Marked Surface

1SS272 (A1) (D106)

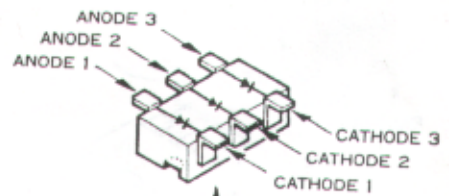

Marked Surface

IMN10 (N10) (D104)

MOTHER BOARD UNIT PARTS LIST

*** MOTHER BOARD UNIT ***			
CP0958002	PCB with Components w/ sub-units		Vers. A, B
	(REG, IF, ANT SW, PLL w/clock, Units)		
CP0958003	PCB with Components w/ sub-units		Ver. USA
	(REG, IF, ANT SW, PLL w/clock, Units)		
F3018102C	Printed Circuit Board		
Q101	G3327147Y	Transistor	2SC2714Y TE85R
Q102	G3329547	Transistor	2SC2954-T2
Q103	G1090732	IC	M57796MA
Q104	G3070033	Transistor	DTC144EK-T97
Q105	G3070033	Transistor	DTC144EK-T97
Q106	G3327127G	Transistor	2SC2712GR TE85R
Q107	G3327147G	Transistor	2SC2714Y TE85R
Q108	G3331207	Transistor	2SC3120 TE85R
Q109	G3070031	Transistor	DTC124TK-T97
Q110	G3070030	Transistor	DTA124EK-T97
Q111	G3070028	Transistor	IMX5-T108
Q112	G3327127G	Transistor	2SC2712GR TE85R
Q113	G3327127G	Transistor	2SC2712GR TE85R
D101	G2070009	Diode	1SS184 TE85R
D102	G2070003	Diode	1SS226 TE85R
D103	G2070009	Diode	1SS184 TE85R
D104	G2070078	Diode	1MN10-T108
D105	G2090317	Diode	21DQ04
D106	G2070048	Diode	1SS272 TE85R
D107	G2070003	Diode	1SS226 TE85R
D108	G2070003	Diode	1SS226 TE85R
X101	H0102913 R3129530	Crystal Crystal Dumper	UM-1 16.845MHz
XF101	H1102149 R3129530	Crystal Filter Crystal Dumper	17N15AU3
R101	J24185153	Chip Res.	15k Ohm 1/16W
R102	J24185472	Chip Res.	4.7k Ohm 1/16W
R103	J24185821	Chip Res.	820 Ohm 1/16W
R104	J24185100	Chip Res.	10 Ohm 1/16W
R105	J24185221	Chip Res.	220 Ohm 1/16W
R106	J24185221	Chip Res.	220 Ohm 1/16W
R107	J24185681	Chip Res.	680 Ohm 1/16W
R108	J24205479	Chip Res.	4.7 Ohm 1/10W
R109	J24205479	Chip Res.	4.7 Ohm 1/10W
R110	J24185153	Chip Res.	15k Ohm 1/16W
R111	J24185471	Chip Res.	470 Ohm 1/16W
R112	J24185104	Chip Res.	100k Ohm 1/16W
R113	J24185101	Chip Res.	100 Ohm 1/16W
R114	J24185102	Chip Res.	1k Ohm 1/16W
R115	J24185332	Chip Res.	3.3k Ohm 1/16W
R116	J24185471	Chip Res.	470 Ohm 1/16W
R117	J24185564	Chip Res.	560k Ohm 1/16W
R118	J24185102	Chip Res.	1k Ohm 1/16W
R119	J24185101	Chip Res.	100 Ohm 1/16W
R120	J24185224	Chip Res.	220k Ohm 1/16W
R121	J24185471	Chip Res.	470 Ohm 1/16W
R122	J24185222	Chip Res.	2.2k Ohm 1/16W
R123	J24185185	Chip Res.	1.8M Ohm 1/16W
R124	J24185103	Chip Res.	10k Ohm 1/16W
R125	J24185472	Chip Res.	4.7k Ohm 1/10W

MOTHER BOARD UNIT PARTS LIST

R126	J24185103	Chip Res.	10k Ohm	1/16W	
R127	J24185101	Chip Res.	100 Ohm	1/16W	
R128	J24185103	Chip Res.	10k Ohm	1/16W	
R129	J24185334	Chip Res.	330k Ohm	1/16W	
R130	J24185222	Chip Res.	2.2k Ohm	1/16W	
R131	J24185225	Chip Res.	2.2M Ohm	1/16W	
R132	J24185103	Chip Res.	10k Ohm	1/16W	
R133	J24185222	Chip Res.	2.2k Ohm	1/16W	
R134	J24185153	Chip Res.	15k Ohm	1/16W	
R135	J24185183	Chip Res.	18k Ohm	1/16W	
R136	J24185223	Chip Res.	22k Ohm	1/16W	
R137	J24185222	Chip Res.	2.2k Ohm	1/16W	
R138	J24205222	Chip Res.	2.2k Ohm	1/10W	
R139	J24205222	Chip Res.	2.2k Ohm	1/10W	
R140	J24185472	Chip Res.	4.7k Ohm	1/16W	
R141	J24205000	Chip Res.	0 Ohm	1/10W	
R142	J24205000	Chip Res.	0 Ohm	1/10W	
R143	J24185104	Chip Res.	100k Ohm	1/16W	
R144	J24205101	Chip Res.	100 Ohm	1/10W	
R145	J24205100	Chip Res.	10 Ohm	1/10W	
VR101	J60800149	Potentiometer w/S101	20k Ohm	VOL	A
VR102	J60800150	Potentiometer	20k Ohm	SQL	B
	R7130330	Washer for VR101,102			
C101	K22171008	Chip Cap.	0.047uF	50V	F
C102	K22170235	Chip Cap.	100pF	50V	CH
C103	K22170235	Chip Cap.	100pF	50V	CH
C104	K22170235	Chip Cap.	100pF	50V	CH
C105	K22120805	Chip Cap.	0.068uF	16V	R
C106	K22170805	Chip Cap.	0.001uF	50V	B
C107	K22170805	Chip Cap.	0.001uF	50V	B
C108	K22170211	Chip Cap.	10pF	50V	CH
C109	K22170805	Chip Cap.	0.001uF	50V	B
C110	K22170209	Chip Cap.	8pF	50V	CH
C111	K22170805	Chip Cap.	0.001uF	50V	B
C112	K22170805	Chip Cap.	0.001uF	50V	B
C113	K40129012	Al Electro Cap.	10uF	16V	
C114	K22120805	Chip Cap.	0.068uF	16V	R
C115	K22170805	Chip Cap.	0.001uF	50V	B
C116	K22170805	Chip Cap.	0.001uF	50V	B
C117	K22170217	Chip Cap.	18pF	50V	CH
C118	K40129059	Al Electro Cap.	4.7uF	16V	
C119	K22170805	Chip Cap.	0.001uF	50V	B
C120	K70087106	Tantalum Cap.	10uF	6.3V	
C121	K22170805	Chip Cap.	0.001uF	50V	B
C122	K22170805	Chip Cap.	0.001uF	50V	B
C123	K22170805	Chip Cap.	0.001uF	50V	B
C124	K22170805	Chip Cap.	0.001uF	50V	B
C125	K22170805	Chip Cap.	0.001uF	50V	B
C126	K22170805	Chip Cap.	0.001uF	50V	B
C127	K22170805	Chip Cap.	0.001uF	50V	B
C128	K22170805	Chip Cap.	0.001uF	50V	B
C129	K22170208	Chip Cap.	7pF	50V	CH
C130	K22170205	Chip Cap.	4pF	50V	CH
C131	K22170211	Chip Cap.	10pF	50V	CH
C132	K22170213	Chip Cap.	12pF	50V	CH
C133	K22170235	Chip Cap.	100pF	50V	CH
C134	K22170805	Chip Cap.	0.001uF	50V	B
C136	K22170208	Chip Cap.	7pF	50V	CH
C137	K22170805	Chip Cap.	0.001uF	50V	B
C138	K22170209	Chip Cap.	8pF	50V	CH

MOTHER BOARD UNIT PARTS LIST

C139	K22170805	Chip Cap.	0.001uF	50V	B
C140	K22170805	Chip Cap.	0.001uF	50V	B
C141	K22170805	Chip Cap.	0.001uF	50V	B
C142	K22170211	Chip Cap.	10pF	50V	CH
C143	K22170202	Chip Cap.	1pF	50V	CK
C144	K22170235	Chip Cap.	100pF	50V	CH
C145	K22170805	Chip Cap.	0.001uF	50V	B
C146	K22170237	Chip Cap.	120pF	50V	CH
C147	K22170817	Chip Cap.	0.01uF	50V	B
C148	K22170817	Chip Cap.	0.01uF	50V	B
C149	K22170817	Chip Cap.	0.01uF	50V	B
C150	K22170817	Chip Cap.	0.01uF	50V	B
C151	K40129012	Al Electro Cap.	10uF	16V	
C152	K78100002	Tantalum Chip Cap.	3.3uF	10V	
C153	K22120805	Chip Cap.	0.068uF	16V	R
C154	K22170805	Chip Cap.	0.001uF	50V	B
C155	K22120805	Chip Cap.	0.068uF	16V	R
C156	K78080002	Tantalum Chip Cap.	4.7uF	6.3V	
C157	K22170235	Chip Cap.	100pF	50V	CH
C158	K22170805	Chip Cap.	0.001uF	50V	B
C159	K22170805	Chip Cap.	0.001uF	50V	B
C160	K40129060	Al Electro Cap.	100uF	16V	
C161	K22170805	Chip Cap.	0.001uF	50V	B
C162	K22120805	Chip Cap.	0.068uF	16V	B
C163	K40109027	Al Electro Cap.	220uF	10V	
C164	K40109026	Al Electro Cap.	100uF	10V	
C165	K22170805	Chip Cap.	0.001uF	50V	B
C166	K78080002	Tantalum Chip Cap.	4.7uF	6.3V	
C167	K22120805	Chip Cap.	0.068uF	16V	R
C168	K22170813	Chip Cap.	0.0047uF	50V	B
C169	K22170821	Chip Cap.	0.022uF	50V	B
C170	K22170821	Chip Cap.	0.022uF	50V	B
C171	K22170805	Chip Cap.	0.001uF	50V	B
C172	K22120805	Chip Cap.	0.068uF	16V	R
C173	K22170805	Chip Cap.	0.001uF	50V	B
C174	K22170805	Chip Cap.	0.001uF	50V	B
C175	K22170209	Chip Cap.	8pF	50V	CH
C176	K22170209	Chip Cap.	8pF	50V	CH
C177	K22170206	Chip Cap.	5pF	50V	CH
C178	K22170203		2pF		
L101	L1690014	RFC	0.18uH		
L102	L1690010	RFC	82nH		
L103	L1690067	RFC	0.68uH		
L104	L1690067	RFC	0.68uH		
L105	L0021800A	Coil			
T101	L0021914	Coil		2276-202	
T102	L0021913	Coil		2276-201	
T103	L0021913	Coil		2276-201	
S101	-----	Switch	w/VR101		
S102	Q9000442 R7130330	Rotary Encoder Washer for S102	EC09P20-04		
J101	P0090682	Connector	53020-1010		
J102	P1090626	Connector	53020-2420		
J103	P0090609	Connector	SB20-02WS		
J104	P1090683	Connector	HEC1781-01-520		
J105	P1090614	Connector	53020-0210		
J106	P1090615	Connector	53020-0310		
	Q5000016	Terminal Post	TP-E MS-60124		

IF UNIT PARTS LAYOUT/CIRCUIT DIAGRAM

IF UNIT (No. 5 XX)

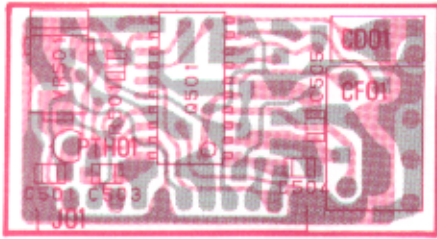

obverse view of "mixed-component" side

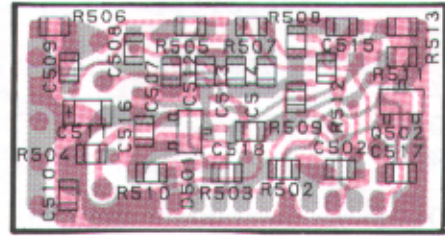

obverse view of "chip-only" side

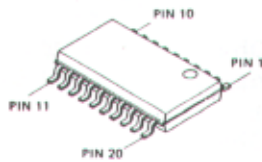

TK10487M (Q501)

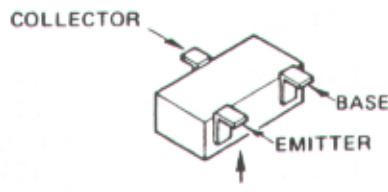

DTC144EK (26) (Q502)

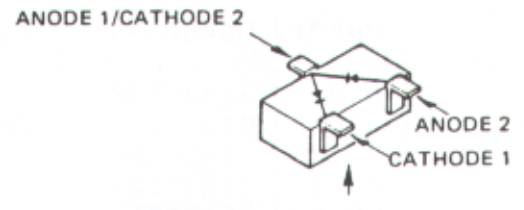

1SS226 (C3) (D501)

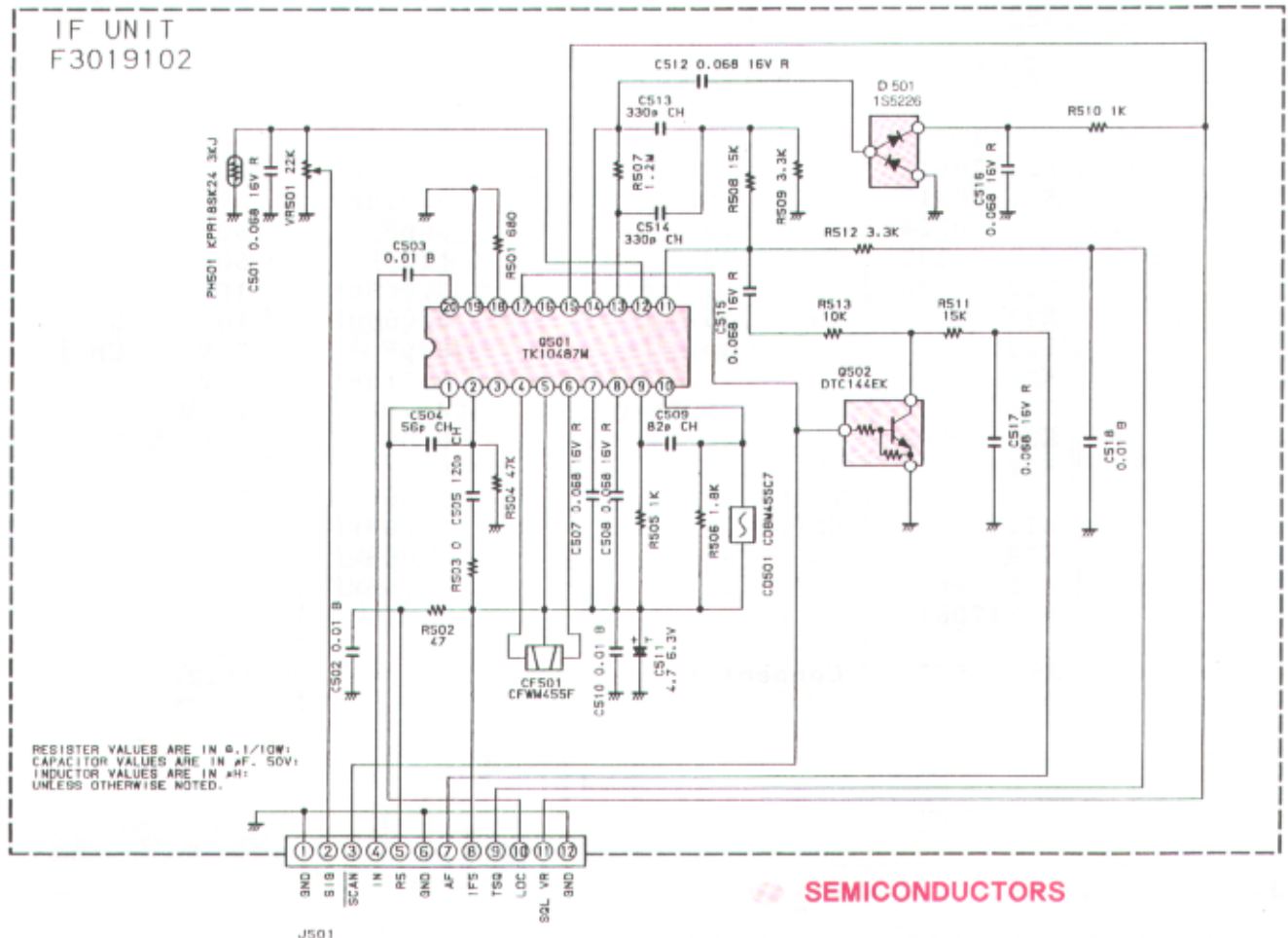

IF UNIT PARTS LIST

*** IF UNIT ***					
CP0961001		PCB with Components			
F3019102A		Printed Circuit Board			
Q501	G1090859	IC	TK10487M		
Q502	G3070033	Transistor	DTC144EK-T97		
D501	G2070003	Diode	1SS226 TE85R		
CF501	H3900395	Ceramic Filter	CWFM455F		
CD501	H7900480	Ceramic Disc	CDBM455C7		
PH501	G9090036	Posistor	KPR18SK24	3KJ	
R501	J24205681	Chip Res.	680 Ohm	1/10W	
R502	J24205470	Chip Res.	47 Ohm	1/10W	
R503	J24205000	Chip Res.	0 Ohm	1/10W	
R504	J24205473	Chip Res.	47k Ohm	1/10W	
R505	J24205102	Chip Res.	1k Ohm	1/10W	
R506	J24205182	Chip Res.	1.8k Ohm	1/10W	
R507	J24205125	Chip Res.	1.2M Ohm	1/10W	
R508	J24205682	Chip Res.	6.8k Ohm	1/10W	
R509	J24205392	Chip Res.	3.9k Ohm	1/10W	
R510	J24205102	Chip Res.	1k Ohm	1/10W	
R511	J24205153	Chip Res.	15k Ohm	1/10W	
R512	J24205332	Chip Res.	3.3k Ohm	1/10W	
R513	J24205103	Chip Res.	10k Ohm	1/10W	
VR501	J50779223	Potentiometer	22k Ohm	RH04AVCJ4W	
C501	K22120805	Chip Cap.	0.068uF	16V	R
C502	K22170817	Chip Cap.	0.01uF	50V	B
C503	K22170817	Chip Cap.	0.01uF	50V	B
C504	K22170229	Chip Cap.	56pF	50V	CH
C505	K22170237	Chip Cap.	120pF	50V	CH
C507	K22120805	Chip Cap.	0.068uF	16V	R
C508	K22120805	Chip Cap.	0.068uF	16V	R
C509	K22170233	Chip Cap.	82pF	50V	CH
C510	K22170817	Chip Cap.	0.01uF	50V	B
C511	K78080002	Tantalum Chip Cap.	4.7uF	6.3V	
C512	K22120805	Chip Cap.	0.068uF	16V	R
C513	K22170805	Chip Cap.	0.001uF	50V	B
C514	K22170239	Chip Cap.	150pF	50V	CH
C515	K22120805	Chip Cap.	0.068uF	16V	R
C516	K22120805	Chip Cap.	0.068uF	16V	R
C517	K22120805	Chip Cap.	0.068uF	16V	R
C518	K22170817	Chip Cap.	0.01uF	50V	B
J501	P0090677	Connector	IMSA-9230B-1-12Z009-T		

REG UNIT PARTS LAYOUT/CIRCUIT DIAGRAM

REG UNIT (No. 6XX)

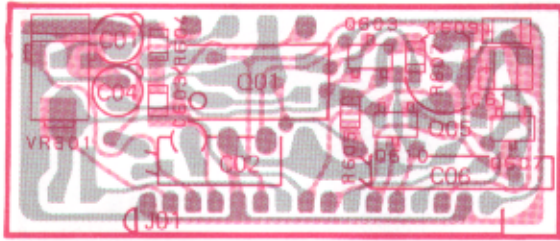

obverse view of "mixed-component" side

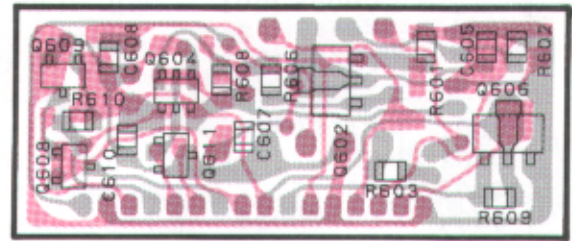

obverse view of "chip-only" side

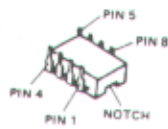

NJM386D (Q601)

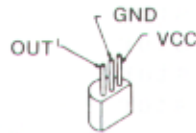

LM2931AZ (Q605)

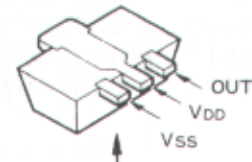

Marked Surface
RH5VA45AA (D5) (Q606)



Marked Surface
2SB799 (ML) (Q602)

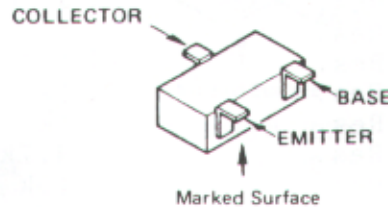

COLLECTOR
BASE
EMITTER
Marked Surface
2SC2712GR (LG) (Q603)
DTA143XK (33) (Q607,608)
DTC144EK (26) (Q609)
DTA123YK (52) (Q610)
DTC124EK (25) (Q611)

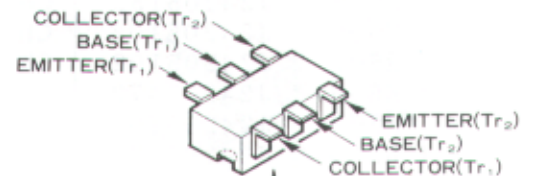

Marked Surface
IMD2 (D2) (Q604)

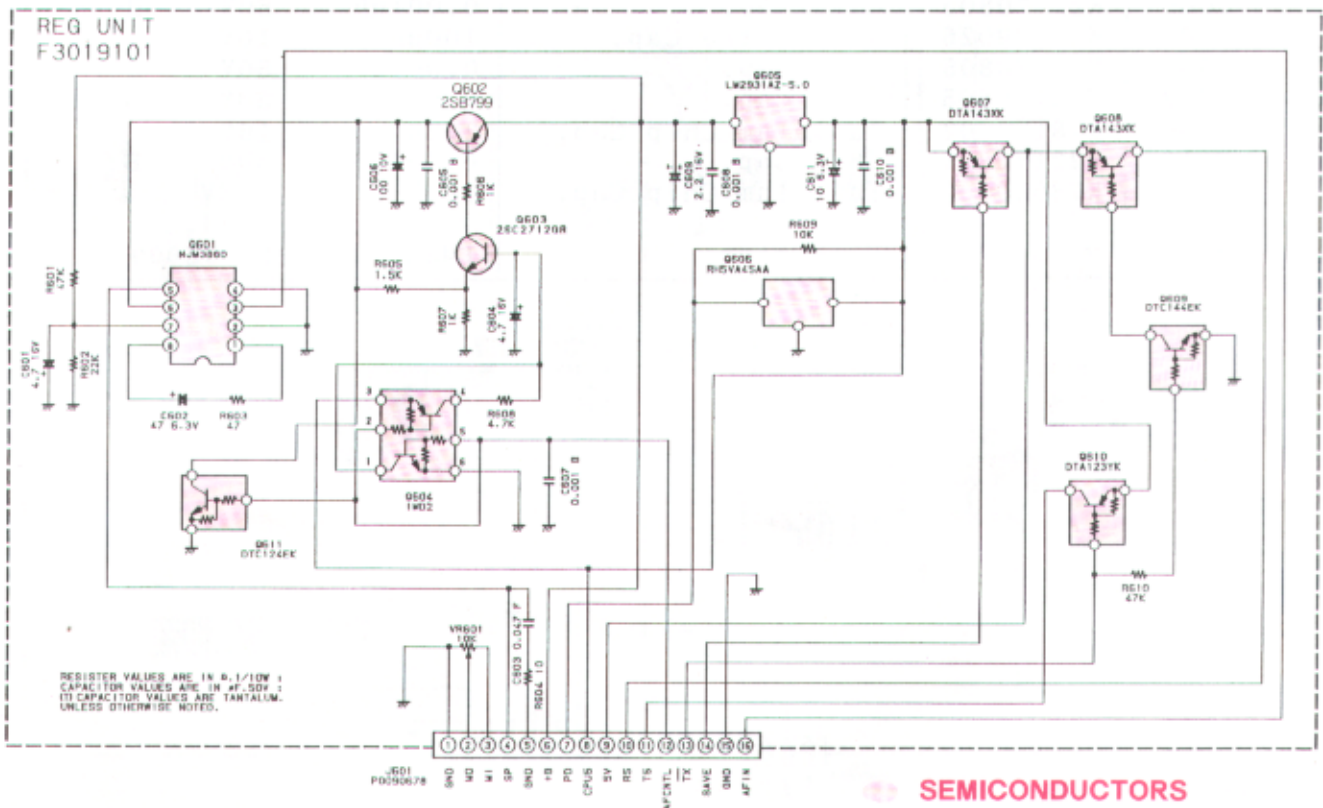

REG UNIT PARTS LIST

*** REG UNIT ***			
CP0960001		PCB with Components	
F3019101A		Printed Circuit Board	
Q601	G1090920	IC	NJM386D
Q602	G3207997L	Transistor	2SB799-T2ML
Q603	G3327127G	Transistor	2SC2712GR TE85R
Q604	G3070026	Transistor	IMD2-T108
Q605	G1090785	IC	LM2931AZ-5.0
Q606	G1090966	IC	RH5VA45AA-T1
Q607	G3070032	Transistor	DTA143XK-T97
Q608	G3070032	Transistor	DTA143XK-T97
Q609	G3070033	Transistor	DTC144EK-T97
Q610	G3070029	Transistor	DTA123YK-T97
Q611	G3070034	Transistor	DTC124EK-T97
R601	J24205473	Chip Res.	47k Ohm 1/10W
R602	J24205223	Chip Res.	22k Ohm 1/10W
R603	J24205470	Chip Res.	47 Ohm 1/10W
R604	J24205100	Chip Res.	10 Ohm 1/10W
R605	J24205152	Chip Res.	1.5k Ohm 1/10W
R606	J24205102	Chip Res.	1k Ohm 1/10W
R607	J24205102	Chip Res.	1k Ohm 1/10W
R608	J24205472	Chip Res.	4.7k Ohm 1/10W
R609	J24205103	Chip Res.	10k Ohm 1/10W
R610	J24205473	Chip Res.	47k Ohm 1/10W
VR601	J50779103	Potentiometer	10k Ohm RH04AVC14W
C602	K40089023	Al Electro Cap.	47uF 6.3V
C603	K22171008	Chip Cap.	0.047uF 50V F
C604	K40129059	Al Electro Cap.	4.7uF 16V
C605	K22170805	Chip Cap.	0.001uF 50V B
C606	K40109026	Al Electro Cap.	100uF 10V
C607	K22170805	Chip Cap.	0.001uF 50V B
C608	K22170805	Chip Cap.	0.001uF 50V B
C609	K78120002	Tantalum Chip Cap.	2.2uF 16V
C610	K22170805	Chip Cap.	0.001uF 50V B
C611	K78080003	Tantalum Chip Cap.	10uF 6.3V
J601	P0090678	Connector	IMSA-9230B-1-16Z009-T

ANT SW UNIT PARTS LAYOUT/CIRCUIT DIAGRAM

ANT SW UNIT (No. 7XX)

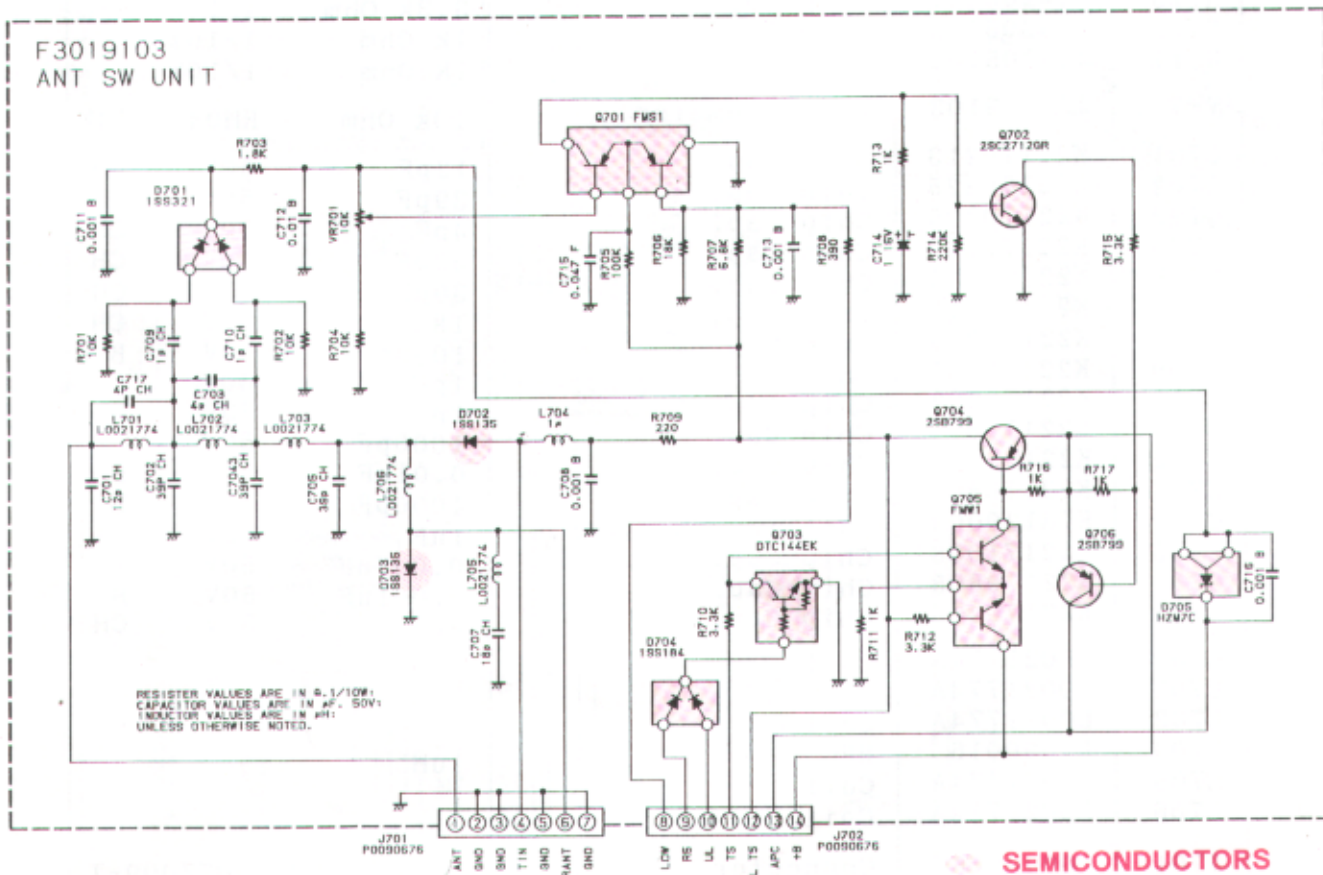
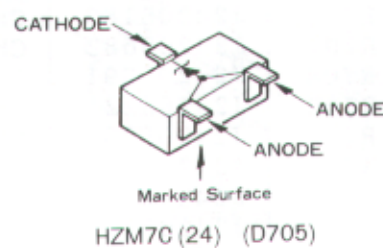
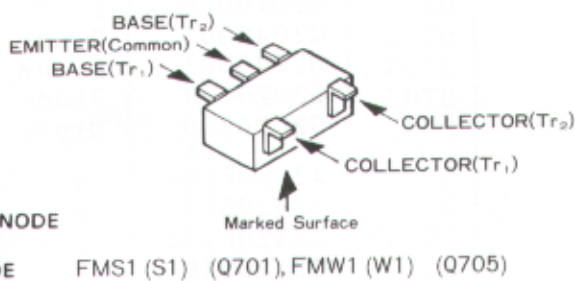
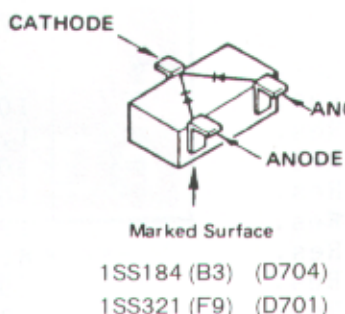
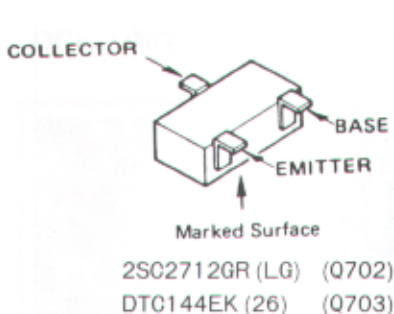
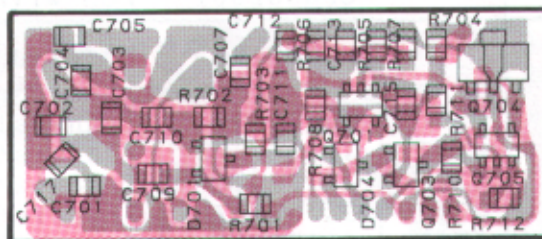
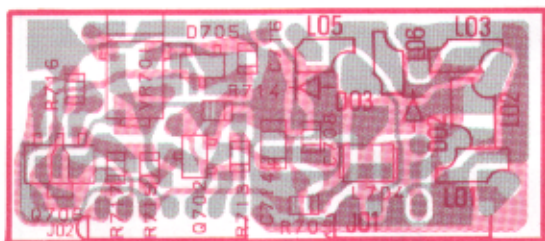

SEMICONDUCTORS

ANT SW UNIT PARTS LIST

*** ANT SW UNIT ***			
CP0962001		PCB with Components	
F3019103		Printed Circuit Board	
Q701	G3070008	Transistor	FMS1-T98
Q702	G3327127G	Transistor	2SC2712GR TE85R
Q703	G3070033	Transistor	DTC144EK-T97
Q704	G3207997L	Transistor	2SB799-T2ML
Q705	G3070009	Transistor	FMW1-T98
Q706	G3207997L	Transistor	2SB799-T2ML
D701	G2070076	Diode	1SS321 TE85R
D702	G2040001	Diode	1SS135-T91
D703	G2040001	Diode	1SS135-T91
D704	G2070009	Diode	1SS184 TE85R
D705	G2070070	Diode	HZM7C-TR
R701	J24205103	Chip Res.	10k Ohm 1/10W
R702	J24205103	Chip Res.	10k Ohm 1/10W
R703	J24205182	Chip Res.	1.8k Ohm 1/10W
R704	J24205103	Chip Res.	10k Ohm 1/10W
R705	J24205104	Chip Res.	100k Ohm 1/10W
R706	J24205183	Chip Res.	18k Ohm 1/10W
R707	J24205682	Chip Res.	6.8k Ohm 1/10W
R708	J24205391	Chip Res.	390 Ohm 1/10W
R709	J24205221	Chip Res.	220 Ohm 1/10W
R710	J24205332	Chip Res.	3.3k Ohm 1/10W
R711	J24205102	Chip Res.	1k Ohm 1/10W
R712	J24205332	Chip Res.	3.3k Ohm 1/10W
R713	J24205102	Chip Res.	1k Ohm 1/10W
R714	J24205224	Chip Res.	220k Ohm 1/10W
R715	J24205332	Chip Res.	3.3k Ohm 1/10W
R716	J24205102	Chip Res.	1k Ohm 1/10W
R717	J24205102	Chip Res.	1k Ohm 1/10W
VR701	J50779103	Potentiometer	10k Ohm RH04AVC14W
C701	K22170213	Chip Cap.	12pF 50V CH
C702	K22170225	Chip Cap.	39pF 50V CH
C703	K22170205	Chip Cap.	4pF 50V CH
C704	K22170225	Chip Cap.	39pF 50V CH
C705	K22170225	Chip Cap.	39pF 50V CH
C707	K22170217	Chip Cap.	18pF 50V CH
C708	K22170805	Chip Cap.	1000pF 50V B
C709	K22170202	Chip Cap.	1pF 50V CH
C710	K22170202	Chip Cap.	1pF 50V CH
C711	K22170805	Chip Cap.	1000pF 50V B
C712	K22170817	Chip Cap.	0.01uF 50V B
C713	K22170805	Chip Cap.	1000pF 50V B
C714	K78120009	Tantalum Chip Cap.	1uF 16V
C715	K22171008	Chip Cap.	0.047uF 50V F
C716	K22170805	Chip Cap.	0.001uF 50V B
C717	K22170205	Chip Cap.	4pF 50V CH
L701	L0021774A	Coil	
L702	L0021774A	Coil	
L703	L0021774A	Coil	
L704	L1690016	RFC	1uH
L705	L0021774A	Coil	
L706	L0021774A	Coil	
J701	P0090676	Connector	1MSA-9230B-1-07Z009-T
J702	P0090676	Connector	1MSA-9230B-1-07Z009-T

PLL,CLOCK UNIT PARTS LAYOUT/CIRCUIT DIAGRAM

PLL UNIT (No. 8 X X)

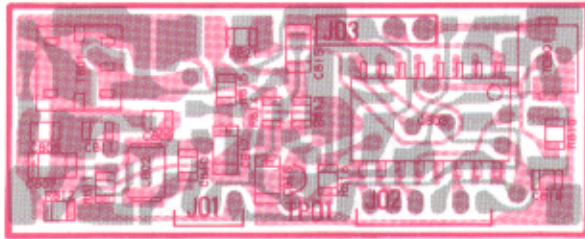

obverse view of "mixed-component" side

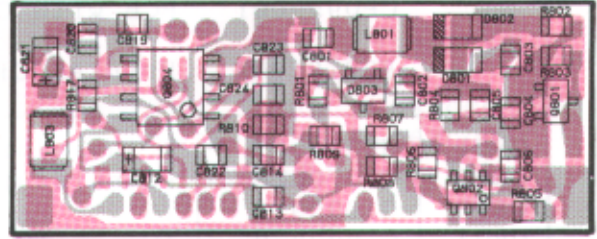

obverse view of "chip-only" side

CLOCK UNIT (No. 9 X X)

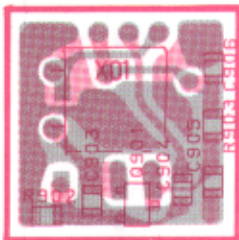

obverse view of "mixed-component" side

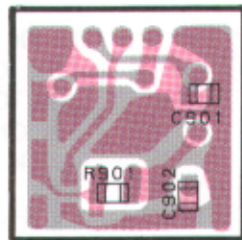

obverse view of "chip-only" side

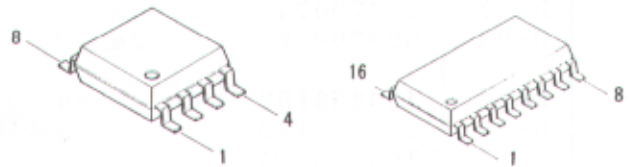

μPB569G (Q804)

MB87076PF (Q803)

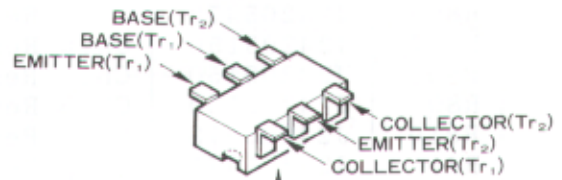

Marked Surface

IMX5 (X5) (Q805)

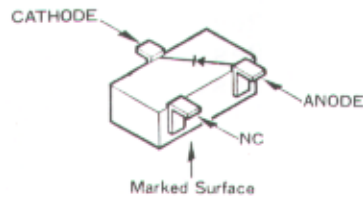

1SS153 (A9) (D803)

COLLECTOR



Marked Surface

2SC2712GR (LG) (Q901)

2SC3356 (R24) (Q801)

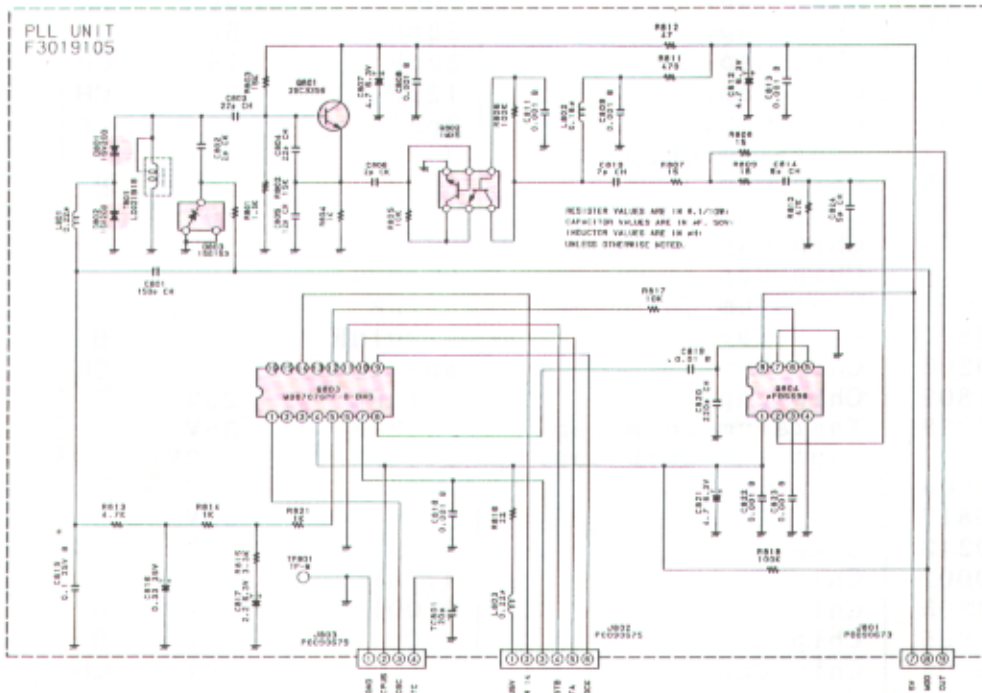
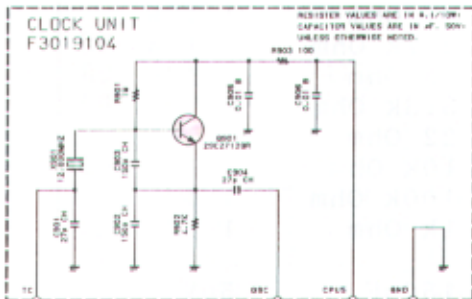

PLL,CLOCK UNIT PARTS LIST

*** PLL UNIT ***

CP0959001 PCB with Components w/ CLOCK Unit

F3019105A Printed Circuit Board

Q801	G3333567	Transistor	2SC3356-T2B		
Q802	G3070028	Transistor	IMX5-T108		
Q803	G1090934	IC	MB87076PF-G-BND-TF		
Q804	G1090870	IC	uPB569G		
D801	G2070074	Diode	1SV200-TR		
D802	G2070074	Diode	1SV200-TR		
D803	G2070032	Diode	1SS153-T2B		
R801	J24205152	Chip Res.	1.5k Ohm	1/10W	
R802	J24205153	Chip Res.	15k Ohm	1/10W	
R803	J24205153	Chip Res.	15k Ohm	1/10W	
R804	J24205102	Chip Res.	1k Ohm	1/10W	
R805	J24205472	Chip Res.	4.7k Ohm	1/10W	
R806	J24205473	Chip Res.	47k Ohm	1/10W	
R807	J24205150	Chip Res.	15 Ohm	1/10W	
R808	J24205150	Chip Res.	15 Ohm	1/10W	
R809	J24205150	Chip Res.	15 Ohm	1/10W	
R810	J24205473	Chip Res.	47k Ohm	1/10W	
R811	J24205471	Chip Res.	470 Ohm	1/10W	
R812	J24205470	Chip Res.	47 Ohm	1/10W	
R813	J24205472	Chip Res.	4.7k Ohm	1/10W	
R814	J24205102	Chip Res.	1k Ohm	1/10W	
R815	J24205332	Chip Res.	3.3k Ohm	1/10W	
R816	J24205220	Chip Res.	22 Ohm	1/10W	
R817	J24205103	Chip Res.	10k Ohm	1/10W	
R818	J24205104	Chip Res.	100k Ohm	1/10W	
R821	J24205102	Chip Res.	1k Ohm	1/10W	
C801	K22170239	Chip Cap.	150pF	50V	CH
C802	K22170203	Chip Cap.	2pF	50V	CK
C803	K22170219	Chip Cap.	22pF	50V	CH
C804	K22170219	Chip Cap.	22pF	16V	CH
C805	K22170213	Chip Cap.	12pF	50V	CH
C806	K22170203	Chip Cap.	2pF	50V	CK
C807	K78080002	Tantalum Chip Cap.	4.7uF	6.3V	
C808	K22170805	Chip Cap.	0.001uF	50V	B
C809	K22170805	Chip Cap.	0.001uF	50V	B
C810	K22170208	Chip Cap.	7pF	50V	CH
C811	K22170805	Chip Cap.	0.001uF	50V	B
C812	K78080002	Tantalum Chip Cap.	4.7uF	6.3V	
C813	K22170805	Chip Cap.	0.001uF	50V	B
C814	K22170206	Chip Cap.	5pF	50V	CH
C815	K22141809	Chip Cap.	0.1uF	25V	B
C816	K78160028	Tantalum Chip Cap.	0.33uF	35V	
C817	K78080009	Tantalum Chip Cap.	2.2uF	6.3V	
C818	K22170805	Chip Cap.	0.001uF	50V	B
C819	K22170817	Chip Cap.	0.01uF	50V	B
C820	K22170243	Chip Cap.	220pF	50V	CH
C821	K78080002	Chip Cap.	4.7uF	6.3V	
C822	K22170805	Chip Cap.	0.001uF	50V	B
C823	K22170805	Chip Cap.	0.001uF	50V	B
C824	K22170206	Chip Cap.	5pF	50V	CH
TC801	K91000151	Trimmer Cap.	20pF		

PLL,CLOCK UNIT PARTS LIST

L801	L1690003	RFC	0.22uH	
L802	L1690014	RFC	0.18uH	
L803	L1690003	RFC	0.22uH	
T801	L0021915	Coil		2276-215
J801	P0090673	Connector	IMSA-9230B-1-03Z009-T	
J802	P0090675	Connector	IMSA-9230B-1-06Z009-T	
J803	P0090679	Connector	IMSA-9210B-1-04-T	
TP801	Q5000052	Terminal Post	TP-M	
	R0128230	Shield Case		
	R0128220	Shield Case Cover		
*** CLOCK UNIT ***				
	CP0964001	PCB with Components		
	F3019104	Printed Circuit Board		
Q901	G3327127G	Transistor	2SC2712GR TE85R	
X901	H0102911	Crystal	UM-1	12.8MHz
	R3129530	Crystal Dumper		
R901	J24205105	Chip Res.	1M Ohm	1/10W
R902	J24205473	Chip Res.	4.7k Ohm	1/10W
R903	J24205101	Chip Res.	100 Ohm	1/10W
C901	K22170221	Chip Cap.	27pF	50V CH
C902	K22170239	Chip Cap.	150pF	50V CH
C903	K22170239	Chip Cap.	150pF	50V CH
C904	K22170221	Chip Cap.	27pF	50V CH
C905	K22170817	Chip Cap.	0.01uF	50V B
C906	K22170817	Chip Cap.	0.01uF	50V B

CONTROL UNIT PARTS LAYOUT

CONTROL UNIT (No. 2 X X)

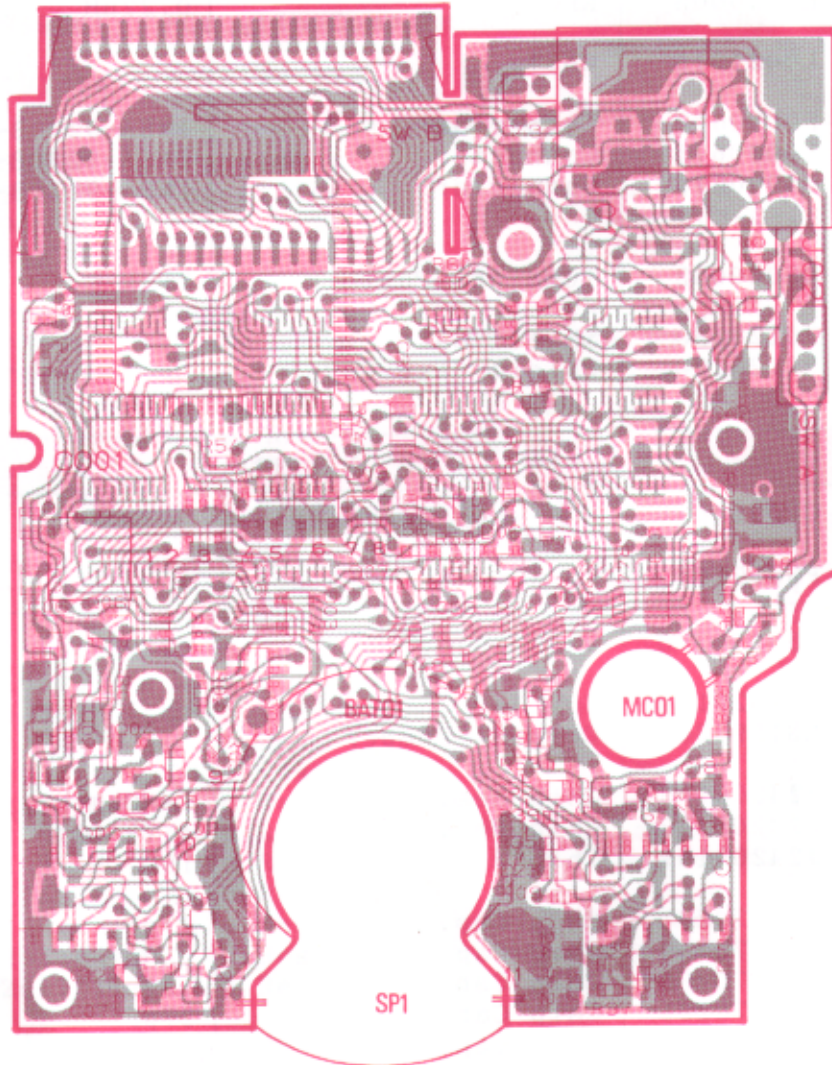

obverse view of "microprocessor" side

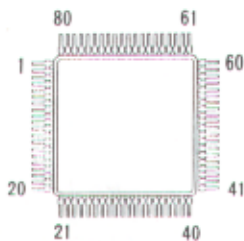

HD404608-A05H (Q201)

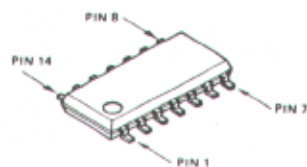

μPD4013BG (Q208)
NJM2902M (Q210)

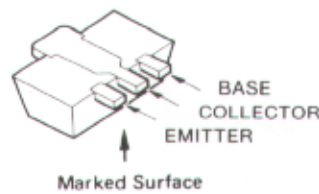

2SB799 (ML) (Q212)

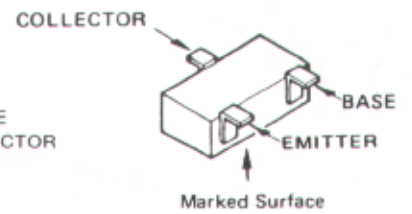

2SC2712GR (LG) (Q209)
DTA124EK (15) (Q206,211)
DTC124TK (05) (Q204)

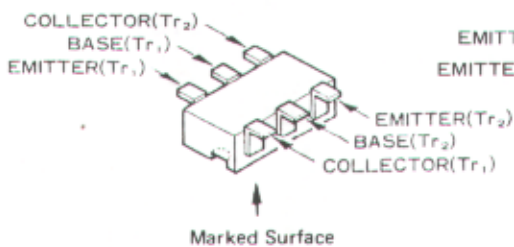

IMZ1 (Z1) (Q202,203)
IMD2 (D2) (Q205)

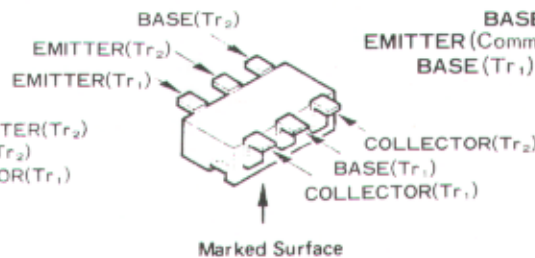

IMH5 (H5) (Q207)

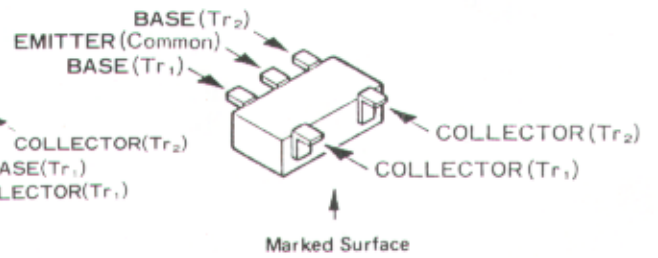

FMW1 (W1) (Q213)

CONTROL UNIT PARTS LAYOUT

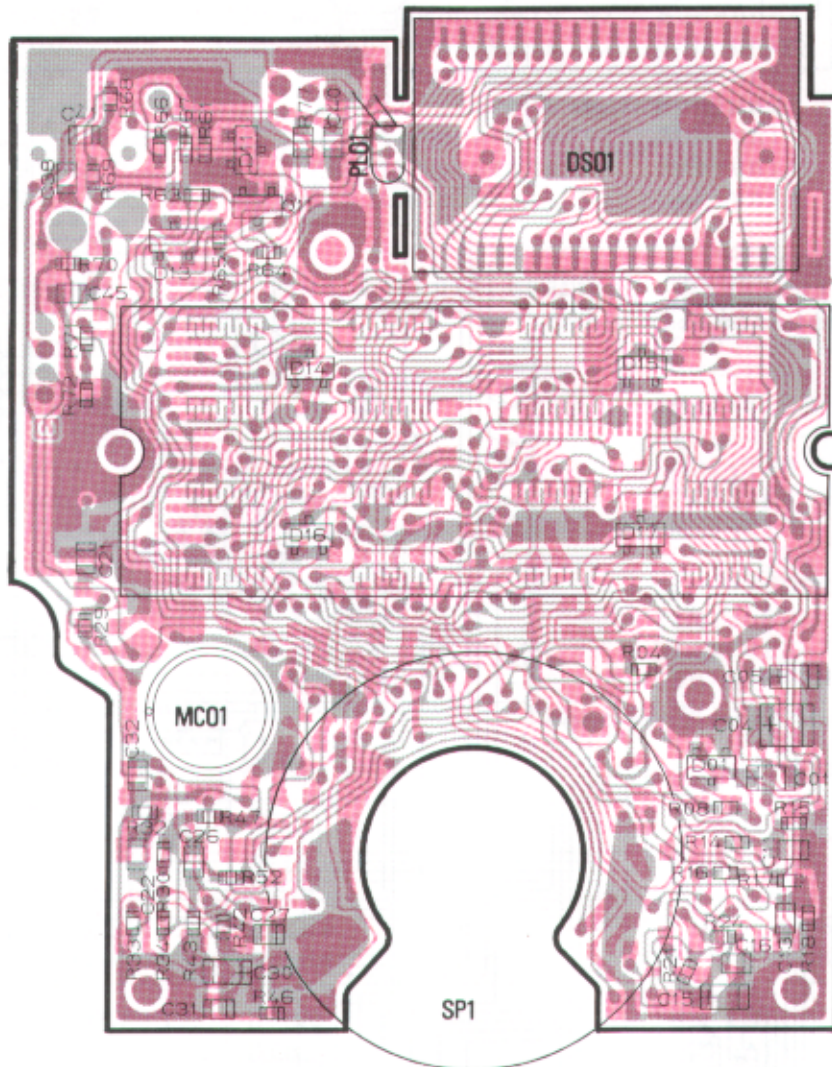

obverse view of "display" side

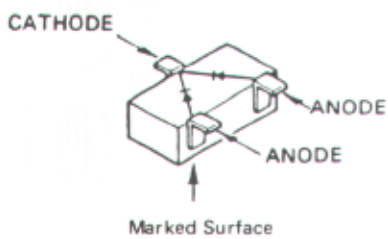

1SS184 (B3) (D208)
SLM-23VMWS (D213)

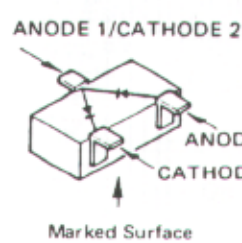

1SS226 (C3)
(D201,209,211)

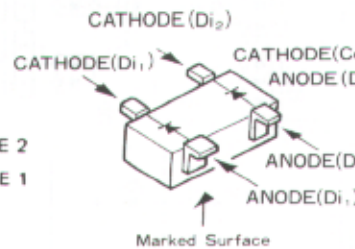

1SS272 (A1) (D206,207)
1SS319 (A4) (D203)

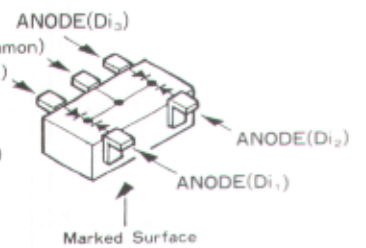

FMN1 (N1) (D204,205)

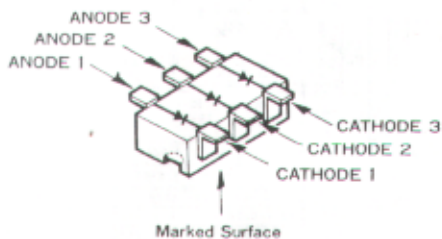

IMN10 (N10) (D202,210)

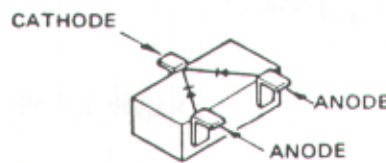

SLM-23VMWS (D213)

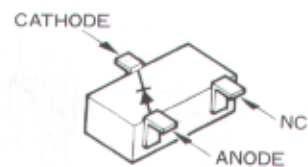

SLM-13MWS
(D214,215,216,217)

CONTROL UNIT CIRCUIT DIAGRAM

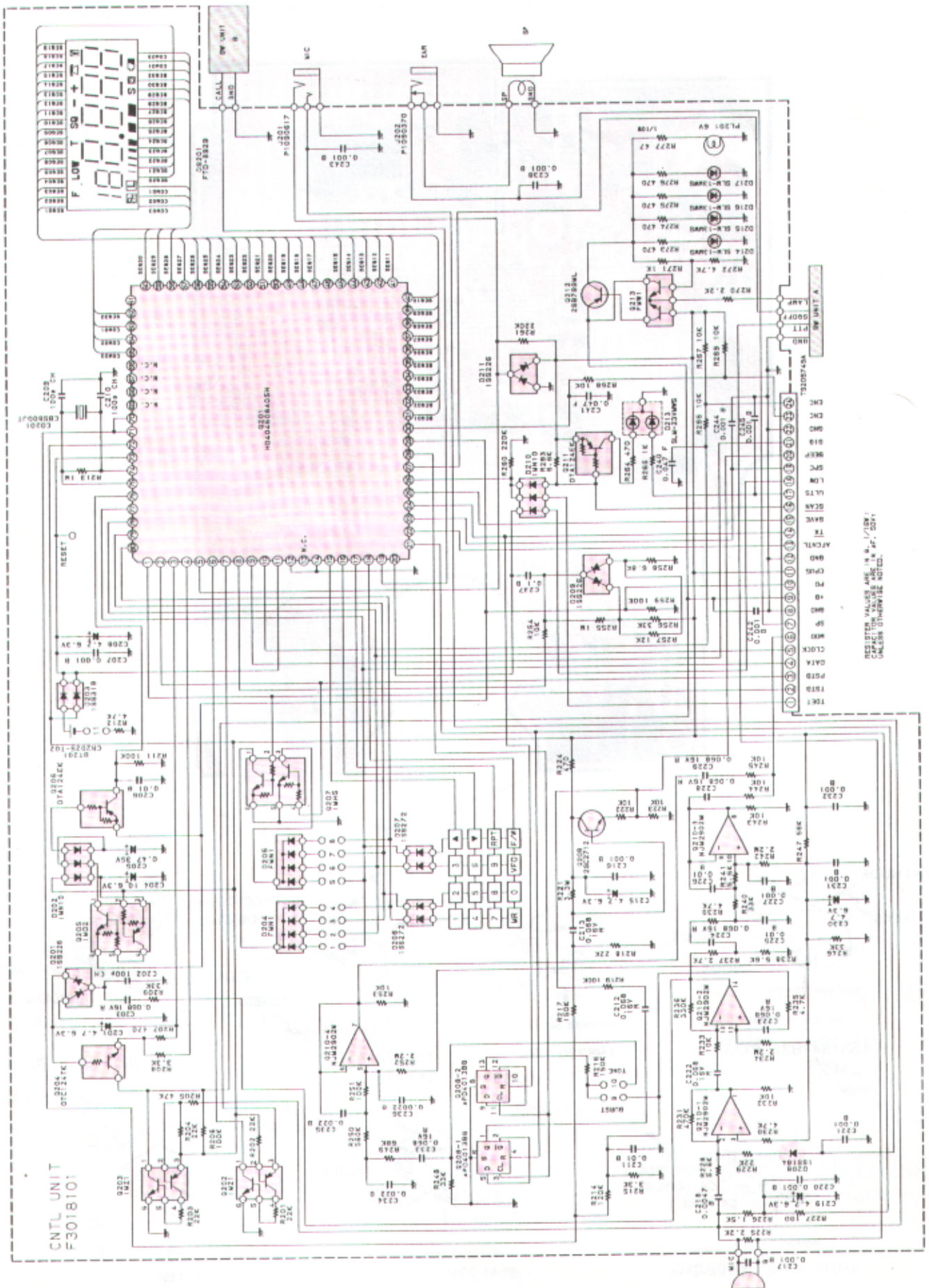

CONTROL UNIT PARTS LIST

*** CNTL UNIT ***

CS0027002	PCB with Components w/	Sub-unit	Ver.A1
CS0027003	PCB with Components w/	Sub-unit	Ver.A2
CS0027004	PCB with Components w/	Sub-unit	Ver.A2 (USA)
CS0027005	PCB with Components w/	Sub-unit	Ver.A3
CS0027006	PCB with Components w/	Sub-unit	Ver.B1
CS0027007	PCB with Components w/	Sub-unit	Ver.B2
CS0027008	PCB with Components w/	Sub-unit	Ver.B3

F3018101C Printed Circuit Board

Q201	G1090919	IC	HD404608-A05H
Q202	G3070025	Transistor	1MZ1-T108
Q203	G3070025	Transistor	1MZ1-T108
Q204	G3070031	Transistor	DTC124TK-T97
Q205	G3070026	Transistor	1MD2-T108
Q206	G3070030	Transistor	DTA124EK-T97
Q207	G3070027	Transistor	1MH5-T108
Q208	G1090668	IC	uPD4013BG
Q209	G3327127G	Transistor	2SC2712GR TE85R
Q210	G1090908	IC	NJM2902M
Q211	G3070030	Transistor	DTA124EK-T97
Q212	G3207997L	Transistor	2SB799-T2ML
Q213	G3070009	Transistor	FMW1-T98
D201	G2070003	Diode	1SS226 TE85R
D202	G2070078	Diode	1MN10-T108
D203	G2070080	Diode	1SS319 TE85R
D204	G2070068	Diode	FMNi-T99
D205	G2070068	Diode	FMN1-T99
D206	G2070048	Diode	1SS272 TE85R
D207	G2070048	Diode	1SS272 TE85R
D208	G2070009	Diode	1SS184 TE85R
D209	G2070003	Diode	1SS226 TE85R
D210	G2070078	Diode	1MN10-T108
D211	G2070003	Diode	1SS226 TE85R
D213	G2070096	Diode	SLM-23VMWS-T97
D214	G2070098	Diode	SLM-13MWS-T97
D215	G2070098	Diode	SLM-13MWS-T97
D216	G2070098	Diode	SLM-13MWS-T97
D217	G2070098	Diode	SLM-13MWS-T97
DS201	G6090075	LCD	FSD-8929A
CO201	H7900530	Ceramic Osc.	CSB800JT
R201	J24185223	Chip Res.	22k Ohm 1/16W
R202	J24185223	Chip Res.	22k Ohm 1/16W
R203	J24185223	Chip Res.	22k Ohm 1/16W
R204	J24185223	Chip Res.	22k Ohm 1/16W
R205	J24185473	Chip Res.	47k Ohm 1/16W
R206	J24185104	Chip Res.	100k Ohm 1/16W
R207	J24185471	Chip Res.	470 Ohm 1/16W
R208	J24185332	Chip Res.	3.3k Ohm 1/16W
R209	J24185333	Chip Res.	33k Ohm 1/16W
R211	J24185104	Chip Res.	100k Ohm 1/16W
R212	J24185472	Chip Res.	4.7k Ohm 1/16W
R213	J24185105	Chip Res.	1M Ohm 1/16W
R214	J24185124	Chip Res.	120k Ohm 1/16W
R215	J24185332	Chip Res.	3.3k Ohm 1/16W

CONTROL UNIT PARTS LIST

R216	J24185151	Chip Res.	150k Ohm	1/16W
R217	J24185154	Chip Res.	150k Ohm	1/16W
R218	J24185223	Chip Res.	22k Ohm	1/16W
R219	J24185104	Chip Res.	100k Ohm	1/16W
R221	J24185335	Chip Res.	3.3M Ohm	1/16W
R222	J24185103	Chip Res.	10k Ohm	1/16W
R223	J24185103	Chip Res.	10k Ohm	1/16W
R224	J24185471	Chip Res.	470 Ohm	1/16W
R225	J24185222	Chip Res.	2.2k Ohm	1/16W
R226	J24185152	Chip Res.	1.5k Ohm	1/16W
R227	J24185101	Chip Res.	100 Ohm	1/16W
R228	J24205562	Chip Res.	5.6k Ohm	1/10W
R229	J24185223	Chip Res.	22k Ohm	1/16W
R230	J24185472	Chip Res.	4.7k Ohm	1/16W
R231	J24185474	Chip Res.	470k Ohm	1/16W
R232	J24185103	Chip Res.	10k Ohm	1/16W
R233	J24185103	Chip Res.	10k Ohm	1/16W
R234	J24185225	Chip Res.	2.2M Ohm	1/16W
R235	J24185472	Chip Res.	4.7k Ohm	1/16W
R236	J24185334	Chip Res.	330k Ohm	1/16W
R237	J24185272	Chip Res.	2.7k NOhm	1/16W
R238	J24185562	Chip Res.	5.6k Ohm	1/16W
R239	J24185472	Chip Res.	4.7k Ohm	1/16W
R240	J24185333	Chip Res.	33k Ohm	1/16W
R241	J24185562	Chip Res.	5.6k Ohm	1/16W
R242	J24185225	Chip Res.	2.2M Ohm	1/16W
R243	J24185103	Chip Res.	10k Ohm	1/16W
R244	J24185103	Chip Res.	10k Ohm	1/16W
R245	J24185103	Chip Res.	10k Ohm	1/16W
R246	J24185333	Chip Res.	33k Ohm	1/16W
R247	J24185563	Chip Res.	56k Ohm	1/16W
R248	J24185333	Chip Res.	33k Ohm	1/16W
R249	J24185683	Chip Res.	68k Ohm	1/16W
R250	J24185564	Chip Res.	560k Ohm	1/16W
R251	J24185104	Chip Res.	100k Ohm	1/16W
R252	J24185225	Chip Res.	2.2M Ohm	1/16W
R253	J24185103	Chip Res.	10k Ohm	1/16W
R254	J24185103	Chip Res.	10k Ohm	1/16W
R255	J24185105	Chip Res.	1M Ohm	1/16W
R256	J24185333	Chip Res.	33k Ohm	1/16W
R257	J24185123	Chip Res.	12k Ohm	1/16W
R258	J24185682	Chip Res.	6.8k Ohm	1/16W
R259	J24185104	Chip Res.	100k Ohm	1/16W
R260	J24185224	Chip Res.	220k Ohm	1/16W
R261	J24185224	Chip Res.	220k Ohm	1/16W
R263	J24185682	Chip Res.	6.8k Ohm	1/16W
R264	J24185471	Chip Res.	470 Ohm	1/16W
R265	J24185102	Chip Res.	1k Ohm	1/16W
R266	J24185103	Chip Res.	10k Ohm	1/16W
R267	J24185103	Chip Res.	10k Ohm	1/16W
R268	J24185103	Chip Res.	10k Ohm	1/16W
R269	J24185103	Chip Res.	10k Ohm	1/16W
R270	J24185222	Chip Res.	2.2k Ohm	1/16W
R271	J24185102	Chip Res.	1k Ohm	1/16W
R272	J24185472	Chip Res.	4.7k Ohm	1/16W
R273	J24185471	Chip Res.	470 Ohm	1/16W
R274	J24185471	Chip Res.	470 Ohm	1/16W
R275	J24185471	Chip Res.	470 Ohm	1/16W
R276	J24185471	Chip Res.	470 Ohm	1/16W
R277	J24205470	Chip Res.	47 Ohm	1/10W
C201	K78080002	Tantalum Chip Cap.	4.7uF	6.3V

CONTROL UNIT PARTS LIST

C202	K22170235	Chip Cap.	100pF	50V	CH
C203	K22120805	Chip Cap.	0.068uF	16V	R
C204	K78080003	Tantalum Chip Cap.	10uF	6.3V	
C205	K78160005	Tantalum Chip Cap.	0.47uF	35V	
C206	K22170817	Chip Cap.	0.01uF	50V	B
C207	K22170805	Chip Cap.	0.001uF	50V	B
C208	K78080002	Tantalum Chip Cap.	4.7uF	6.3V	
C209	K22170235	Chip Cap.	100pF	50V	CH
C210	K22170235	Chip Cap.	100pF	50V	CH
C211	K22170817	Chip Cap.	0.01uF	50V	B
C212	K22120805	Chip Cap.	0.068uF	25V	R
C213	K22120805	Chip Cap.	0.068uF	50V	R
C215	K78080002	Tantalum Chip Cap.	4.7uF	6.3V	
C216	K22170805	Chip Cap.	0.001uF	50V	B
C217	K10176102	Ceramic Cap.	0.001uF	50V	B
C218	K22170813	Chip Cap.	0.0047uF	50V	B
C219	K78080002	Tantalum Chip Cap.	4.7uF	6.3V	
C220	K22170805	Chip Cap.	0.001uF	50V	B
C221	K22170805	Chip Cap.	0.001uF	50V	B
C222	K22120805	Chip Cap.	0.068uF	6.3V	
C223	K22120805	Chip Cap.	0.068uF	50V	R
C224	K22120805	Chip Cap.	0.068uF	50V	R
C225	K22170817	Chip Cap.	0.01uF	50V	B
C226	K22170817	Chip Cap.	0.01uF	50V	B
C227	K22170805	Chip Cap.	0.001uF	50V	B
C228	K22120805	Chip Cap.	0.068uF	50V	R
C229	K22120805	Chip Cap.	0.068uF	50V	R
C230	K78080002	Tantalum Chip Cap.	4.7uF	6.3V	
C231	K22170805	Chip Cap.	0.001uF	50V	B
C232	K22170805	Chip Cap.	0.001uF	50V	B
C233	K22120805	Chip Cap.	0.068uF	50V	R
C234	K22170821	Chip Cap.	0.022uF	50V	B
C235	K22170821	Chip Cap.	0.022uF	50V	B
C236	K22170809	Chip Cap.	0.0022uF	50V	B
C237	K22141809	Chip Cap.	0.1uF	25V	B
C238	K22170805	Chip Cap.	0.001uF	50V	B
C240	K22141003	Chip Cap.	0.047uF	25V	F
C241	K22141003	Chip Cap.	0.047uF	25V	F
C242	K22170805	Chip Cap.	0.001uF	50V	B
C243	K22170805	Chip Cap.	0.001uF	50V	B
C244	K22170805	Chip Cap.	0.001uF	50V	B
C245	K22170805	Chip Cap.	0.001uF	50V	B
MC201	M3290008	Microphone	EM-78CYE		
J201	P1090617	Connector (EXT Mic)	HSJ1102-01-540		
J202	P1090370	Connector (Ear)	HSJ0836-01-010		
BAT201	Q9000366 R7130220	Lithium Battery Insulator Sheet	CR2025-T02		
PL201	Q1000060 S6000146 R0128240 S2000030 R0129400 R0128690	Lamp Diffusor Holder Rubber Conductor Shield Plate SW Spring	KD-0001-01 6V 40mA		

SW UNIT A & B

SW UNIT A (No. 3 × ×)

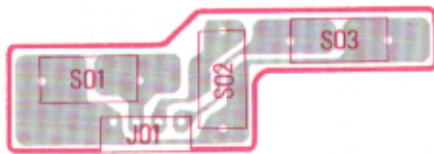

obverse view of "sw" side

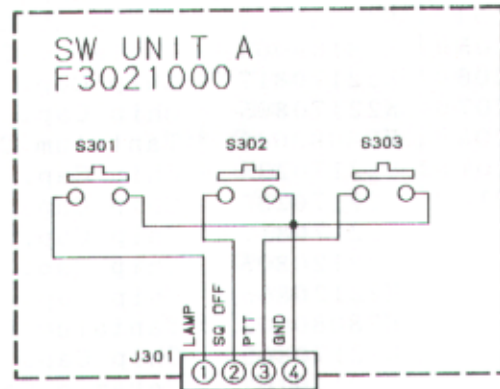

SW UNIT B (No. 4 × ×)



obverse view of "sw" side

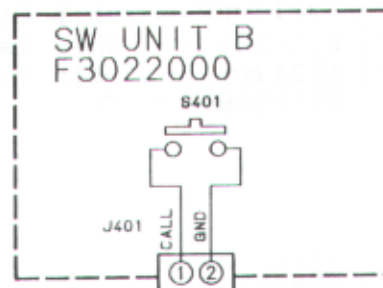

*** SW UNIT A ***

CP0952001 PCB w/Components

F3021000 Printed Circuit Board

S301	N5090027	TACT Switch	SKHLAB
S302	N5090027	TACT Switch	SKHLAB
S303	N5090027	TACT Switch	SKHLAB
J301	P0090674	Connector	IMSA-9230B-1-04Z009-T

*** SW UNIT B ***

CP0951001 PCB w/Components

F3022000 Printed Circuit Board

S401	N5090027	TACT Switch	SKHLAB
J401	P0090672	Connector	IMSA-9230B-1-02Z009-T

(Version B, Only) T-BURST UNIT

T-BURST UNIT (No.11XX)

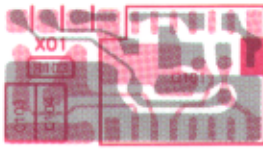

obverse view of "IC" side

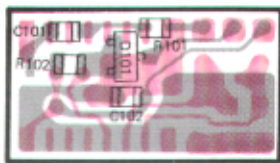

obverse view of "Diode" side

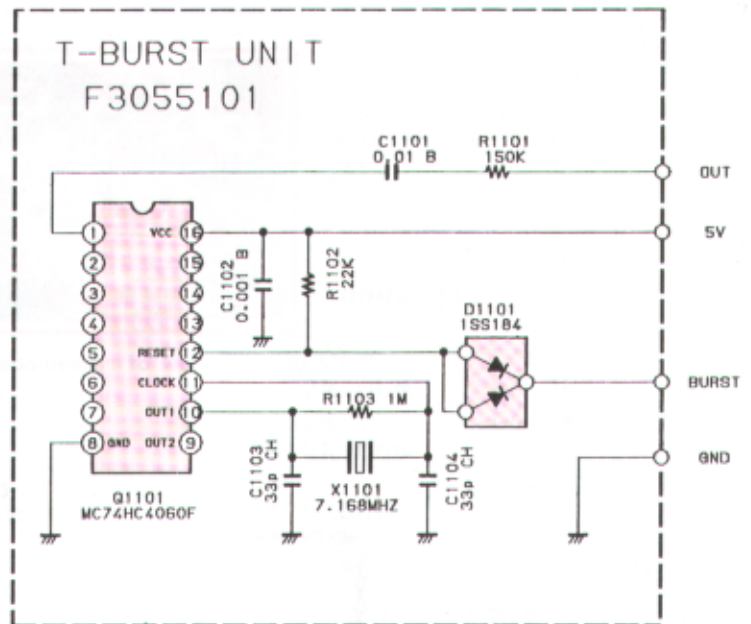

SEMICONDUCTORS

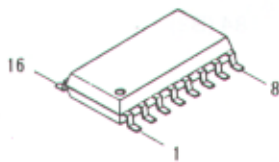

MC74HC4060F (Q1101)

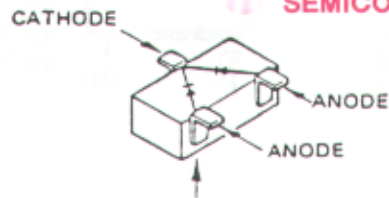

1SS184 (B3) (D1101)

*** T-BURST UNIT ***

CP1934001 PCB with Components

F3055101 Printed Circuit Board

Q1101	G1090984	IC	MC74HC4060FL
D1101	G2070009	Diode	1SS184 TE85R
X1101	H0102930	Crystal	UM-1 7.168MHz
R1101	J24185151	Chip Res.	150k ohm 1/16W
R1102	J24185223	Chip Res.	22k ohm 1/16W
R1103	J24185105	Chip Res.	1M ohm 1/16W
C1101	K22170817	Chip Cap.	0.01µF B
C1102	K22174809	Chip Cap.	0.001µF B
C1103	K22170223	Chip Cap.	33pF CH
C1104	K22170223	Chip Cap.	33pF CH

FTS-17 PARTS LAYOUT/CIRCUIT DIAGRAM (OPTION)

FTS-17 (No.XX)

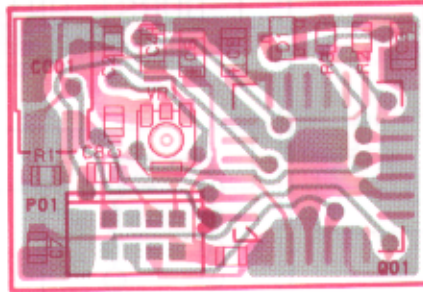

obverse view of "mixed-component" side

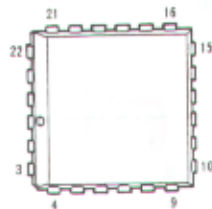

MX365LH (Q1)

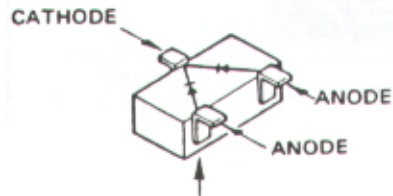

1SS184 (B3) (D1)

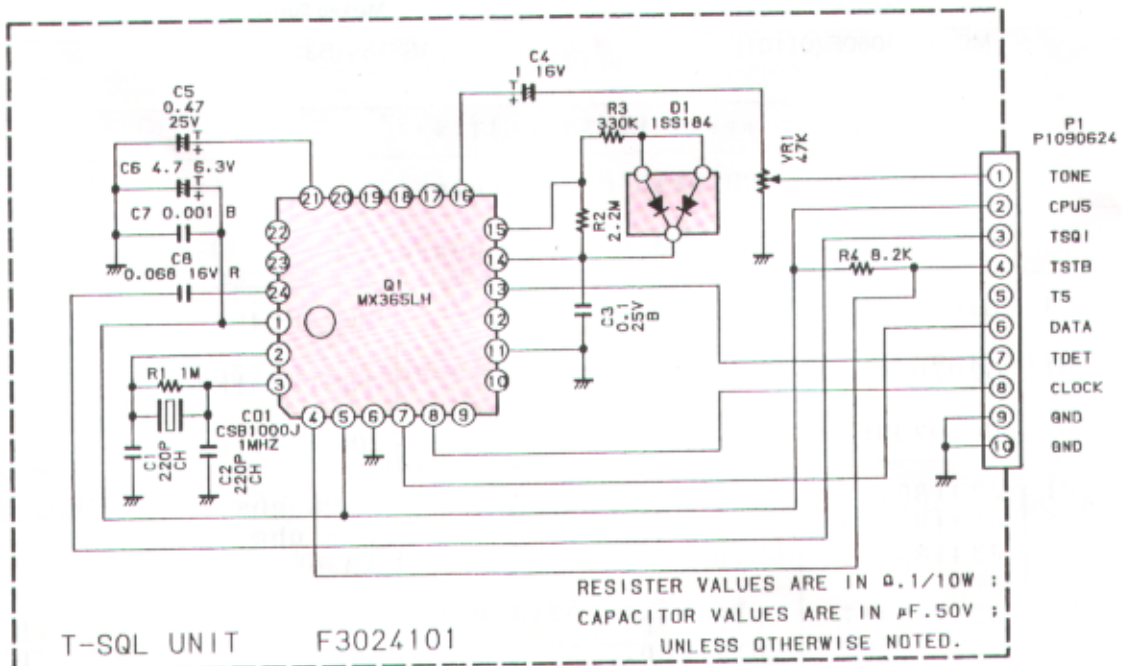

SEMICONDUCTORS

FTS-17 PARTS LIST

***** FTS-17 *****					
CP1645001		PCB with Components			
F3024101		Printed Circuit Board			
Q1	G1090897	IC	MX365LH		
D1	G2070009	Diode	1SS184 TE85R		
CO1	H7900550	Ceramic Osc.	CSB1000J221T		
R1	J24205105	Chip Res.	1M Ohm	1/10W	
R2	J24205225	Chip Res.	2.2M Ohm	1/10W	
R3	J24205334	Chip Res.	330k Ohm	1/10W	
R4	J24205822	Chip Res.	8.2k Ohm	1/10W	
VR1	J51780473	Potentiometer	47k Ohm		
C1	K22170243	Chip Cap.	220pF	50V	CH
C2	K22170243	Chip Cap.	220pF	50V	CH
C3	K22141809	Chip Cap.	0.1uF	25V	B
C4	K78120013	Tantalum Chip Cap.	1uF	16V	
C5	K78120012	Tantalum Chip Cap.	0.47uF	16V	
C6	K78080002	Tantalum Chip Cap.	4.7uF	6.3V	
C7	K22170805	Chip Cap.	0.001uF	50V	B
C8	K22120805	Chip Cap.	0.068uF	16V	B
P1	P1090624	Connector	52022-1010		

BLOCK DIAGRAM

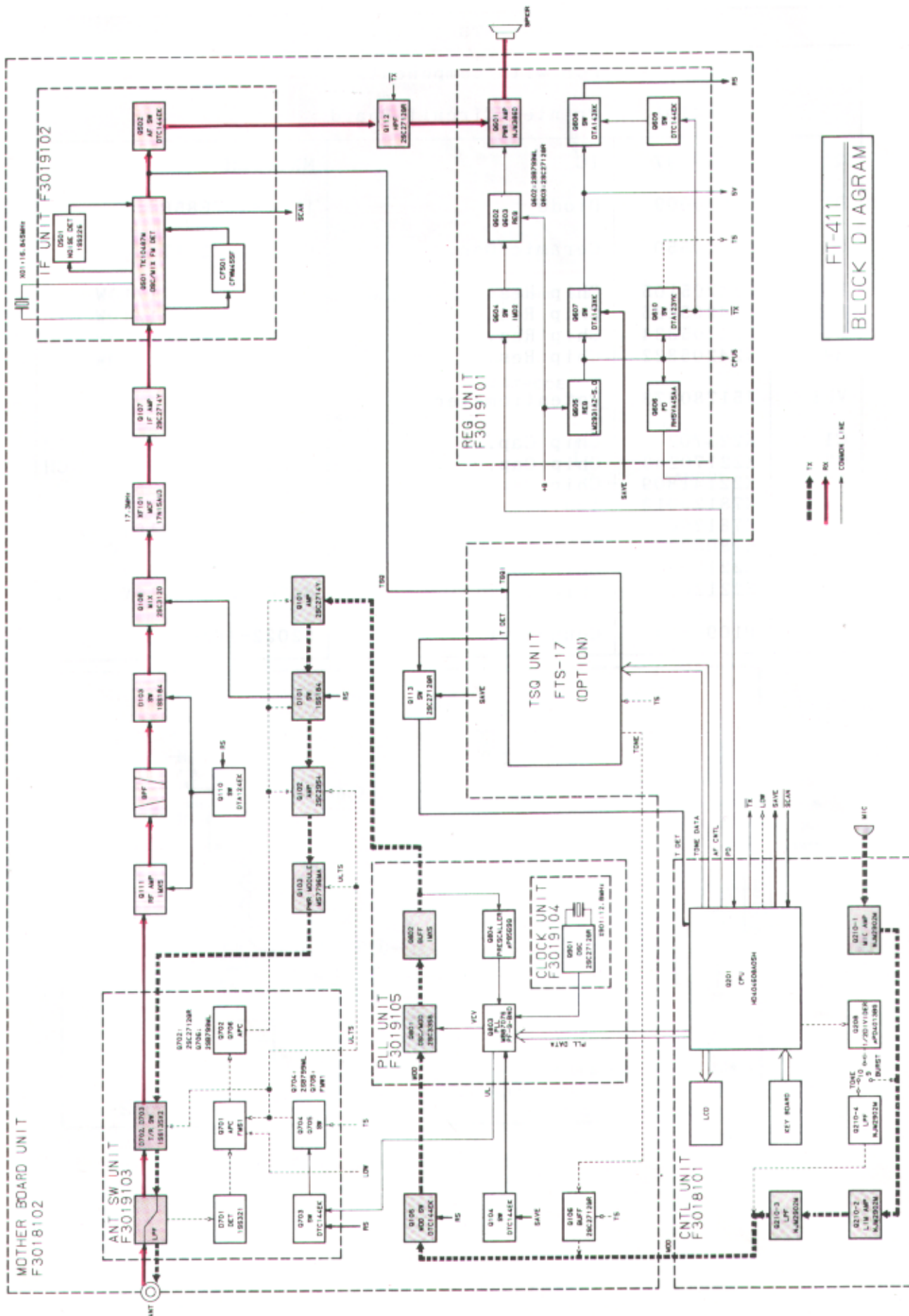

CONNECTION DIAGRAM

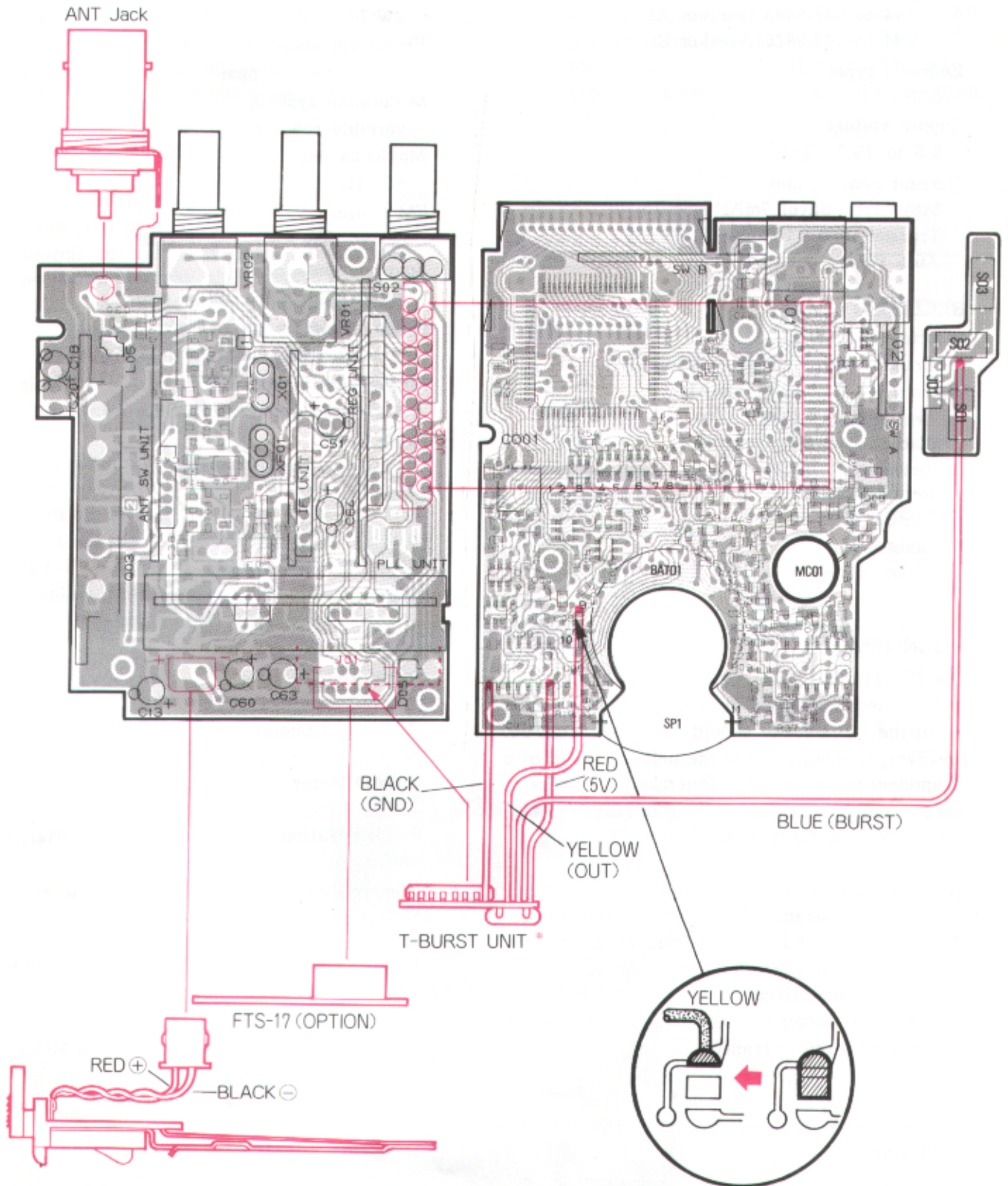

* Version B, Only

SPECIFICATIONS/ALIGNMENT

SPECIFICATIONS

GENERAL

Frequency coverage (MHz):

144 to 147.9995 (version A)

144 to 145.9875 (version B)

Emission type:

G3E

Supply voltage:

5.5 to 15.0 VDC

Current consumption:

Stby (1sec Save) 7mA; Rcv: 150mA;

Transmit (6W): 1300 mA;

Auto Power Off: 6 mA

RECEIVER

Circuit type:

Double-conversion superheterodyne

Sensitivity (for 12dB SINAD):

better than 0.158uV (-10dBu)

Adjacent channel selectivity:

better than 60dB

Intermodulation:

better than 65dB

Audio output:

0.5W @8 ohms for 5% THD (12V)

ALIGNMENT

The FT-411 has been carefully aligned at the factory, and is designed so that, during proper use, no further alignment should ever be required. However, if misused, or in the unlikely event of a component failure, realignment may be necessary. Before realignment, the cause of the fault must be determined and corrected.

The small size of the FT-411 makes it difficult for the average operator to service. For this reason, we recommend that all component replacement and service be performed only by authorized Yaesu representatives. Any service attempt by unauthorized persons is done at the owner's risk, and may void the warranty.

The following test equipment is required for alignment:

RF Signal Generator with calibrated output level at 170 MHz

Deviation Meter (linear detector)

TRANSMITTER

Power output:

5W @ 12V

Frequency stability:

better than 10 ppm

Modulation system:

variable reactance

Maximum deviation:

±5 kHz

FM Noise:

better than -40dB @ 1 kHz

Spurious emissions:

better than 60dB below carrier

Audio distortion (@ 1 kHz):

less than 5%, w/3 kHz deviation

Microphone type:

2-kilohm condenser

Burst tone:

1750 Hz (except version A)

Oscilloscope

AF Millivoltmeter

SINAD Meter

In-Line Wattmeter (accurate at 170 MHz)

Dummy Load (50-ohm, non-reactive at 170 MHz)

Regulated, Adjustable DC Power Supply (2A @ 4 to 17V) with Ammeter

Frequency Counter (±0.2 ppm @ 170 MHz)

AF Signal Generator

DC Voltmeter (10-Megohm impedance)

CAUTION!

The FT-411 cannot be properly aligned with an antenna, because of interaction between the antenna and the transceiver circuitry.

(PLL & Transmitter) ALIGNMENT

PLL VCV (Varactor Control Voltage)

Connect the DC voltmeter between L801 on the PLL Unit and Chassis Ground. Tune the transceiver to 144.000 MHz, close the PTT switch and adjust T801 on the PLL Unit for 0.05 ± 0.05 VDC on the meter.

Transmitter Output Power

Tune the transceiver to the center of the band (145 or 146 MHz), and set the LOW switch to the high power (undeepressed) position. Increase the supply voltage to 13.8V, and adjust VR701 on the Antenna SW Unit for peak output power (at least 5 watts with less than 1.5A supply current). Press the LOW switch and confirm 0.3 to 1.0 watt, then return the supply voltage to 12V.

PLL Reference Frequency

With the transceiver tuned to the center of the band (145 or 146 MHz), adjust TC801 on the PLL Unit, if necessary, so that the display frequency matches the frequency counter when transmitting.

Modulation Level

With the transceiver tuned to the center of the band (145 or 146 MHz), set the AF generator for 25mV injection at 1 kHz to the MIC jack. Adjust VR601 on the Regulator Unit for ± 4.5 kHz deviation on the deviation meter.

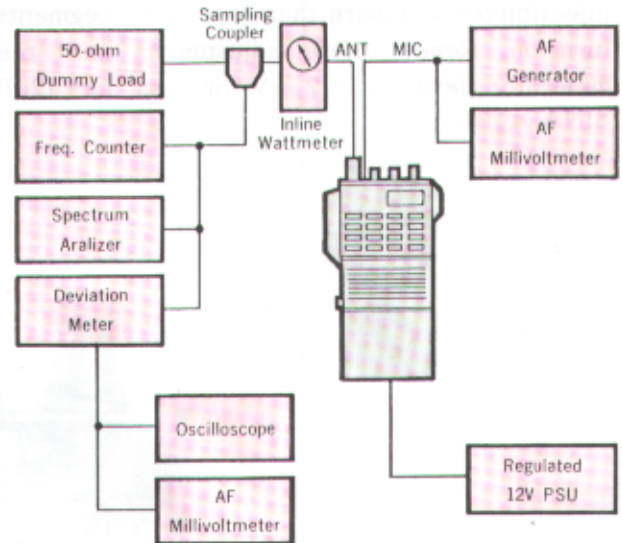

PLL & TRANSMITTER ALIGNMENT SETUP

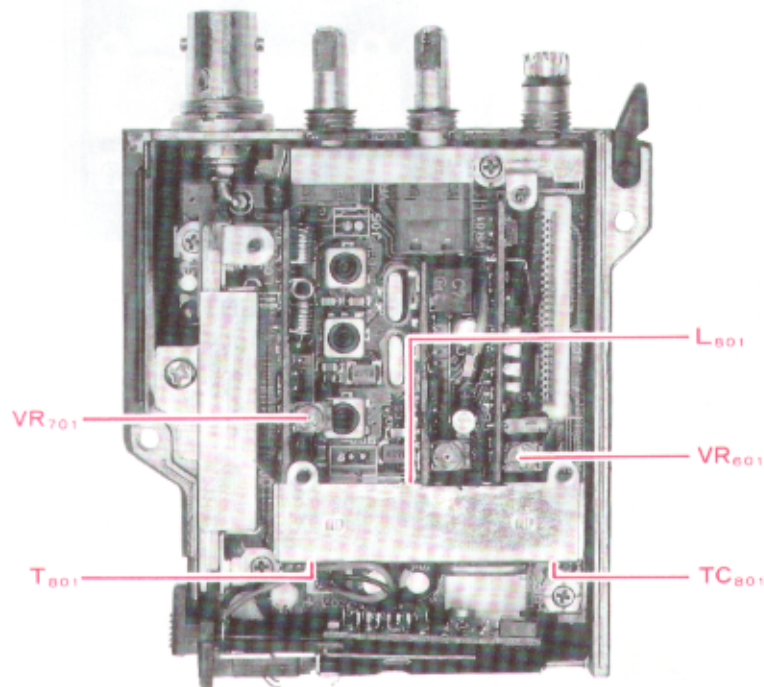

PLL & TRANSMITTER ALIGNMENT POINTS

ALIGNMENT (Receiver)

Set up the test equipment as shown above for receiver alignment.

With the transceiver and RF signal generator both tuned to the center of coverage (145 or 146 MHz), inject a 1 kHz tone with ± 3.5 kHz deviation at 40 dBu to the antenna jack.

Adjust T101 through T103 on the Mother Board for maximum S-meter indication, reducing the injection level if more than four meter segments turn on. Repeat these adjustments until the generator level is 0.2 μ V or less for 12dB SINAD.

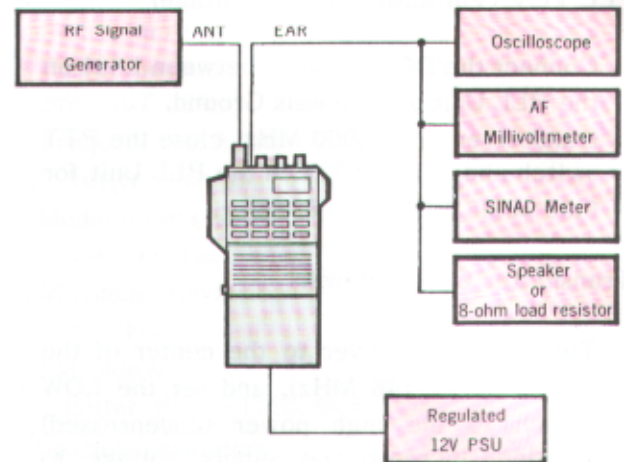

RECEIVER ALIGNMENT SETUP

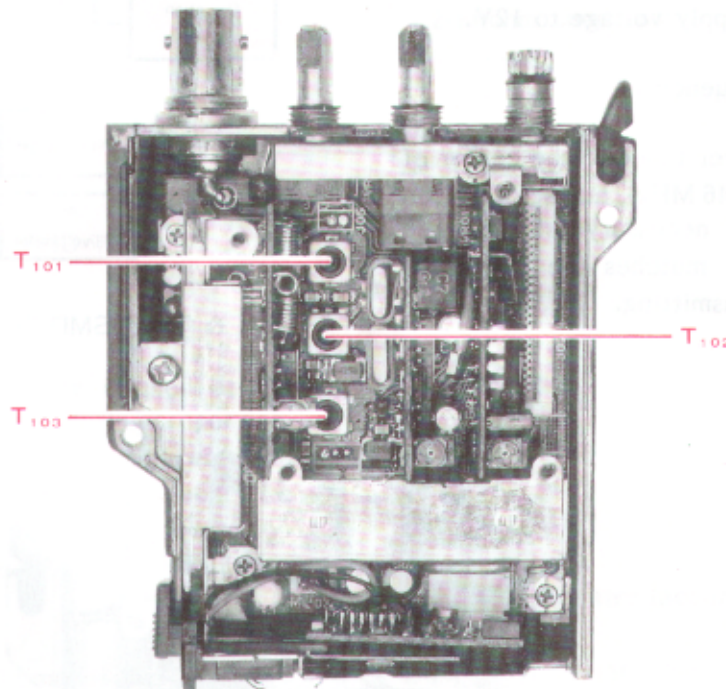

RECEIVER ALIGNMENT POINTS