



SERVICE MANUAL

VHF/UHF ALL MODE TRANSCEIVER

IC-910H

INTRODUCTION

This service manual describes the latest service information for the **IC-910H** VHF/UHF ALL MODE TRANSCEIVER at the time of publication.

VERSION No.	VERSION	SYMBOL
#02	Europe	EUR
#04	Australia	AUS
#06	U.S.A.	USA-1
#07	Korea	KOR

To upgrade quality, any electrical or mechanical parts and internal circuits are subject to change without notice or obligation.

DANGER

NEVER connect the transceiver to an AC outlet or to a DC power supply that uses more than 16 V. This will ruin the transceiver.

DO NOT expose the transceiver to rain, snow or any liquids.

DO NOT reverse the polarities of the power supply when connecting the transceiver.

DO NOT apply an RF signal of more than 20 dBm (100 mW) to the antenna connector. This could damage the transceiver's front end.



ORDERING PARTS

Be sure to include the following four points when ordering replacement parts:

1. 10-digit order numbers
2. Component part number and name
3. Equipment model name and unit name
4. Quantity required

<SAMPLE ORDER>

1110003140 IC LA1150N IC-910H MAIN UNIT 5 pieces
8810005770 Screw BiH M3×8 ZK IC-910H Cover 10 pieces

Addresses are provided on the inside back cover for your convenience.

REPAIR NOTES

1. Make sure a problem is internal before disassembling the transceiver.
2. **DO NOT** open the transceiver until the transceiver is disconnected from its power source.
3. **DO NOT** force any of the variable components. Turn them slowly and smoothly.
4. **DO NOT** short any circuits or electronic parts. An insulated tuning tool **MUST** be used for all adjustments.
5. **DO NOT** keep power ON for a long time when the transceiver is defective.
6. **DO NOT** transmit power into a signal generator or a sweep generator.
7. **ALWAYS** connect a 50 dB to 60 dB attenuator between the transceiver and a deviation meter or spectrum analyzer when using such test equipment.
8. **READ** the instructions of test equipment thoroughly before connecting equipment to the transceiver.

TABLE OF CONTENTS

SECTION 1	SPECIFICATIONS	
SECTION 2	INSIDE VIEWS	
2 - 1	IC-910H	2 - 1
2 - 2	UX-910 (OPTIONAL UNIT)	2 - 3
SECTION 3	DISASSEMBLY AND OPTION INSTRUCTIONS	
SECTION 4	CIRCUIT DESCRIPTION	
SECTION 5	ADJUSTMENT PROCEDURES	
SECTION 6	PARTS LIST	
SECTION 7	MECHANICAL PARTS	
SECTION 8	SEMI-CONDUCTOR INFORMATION	
SECTION 9	BOARD LAYOUTS	
9 - 1	VR-A BOARD	9 - 1
9 - 2	VR-B BOARD	9 - 1
9 - 3	RIT BOARD	9 - 1
9 - 4	FUNC BOARD	9 - 3
9 - 5	MIC BOARD	9 - 3
9 - 6	JACK BOARD	9 - 3
9 - 7	DRV BOARD	9 - 3
9 - 8	VARISTOR-A BOARD	9 - 3
9 - 9	VARISTOR-B BOARD	9 - 3
9 - 10	VARISTOR-C BOARD	9 - 3
9 - 11	DISPLAY BOARD	9 - 5
9 - 12	PA UNIT	9 - 7
9 - 13	PLL UNIT	9 - 9
9 - 14	MAIN UNIT	9 - 11
9 - 15	UX-910 MAIN UNIT	9 - 13
SECTION 10	BLOCK DIAGRAMS	
10 - 1	MAIN UNIT	10 - 1
10 - 2	PA AND PLL UNITS	10 - 2
10 - 3	FRONT UNIT	10 - 3
10 - 4	UX-910	10 - 3
SECTION 11	WIRING DIAGRAM	
SECTION 12	VOLTAGE DIAGRAMS	
12 - 1	FRONT UNIT	12 - 1
12 - 2	PLL UNIT	12 - 2
12 - 3	PA UNIT (1)	12 - 3
12 - 4	PA UNIT (2)	12 - 4
12 - 5	MAIN UNIT (1)	12 - 5
12 - 6	MAIN UNIT (2)	12 - 6
12 - 7	MAIN UNIT (3)	12 - 6
12 - 8	UX-910 MAIN UNIT (1)	12 - 7
12 - 9	UX-910 MAIN UNIT (2)	12 - 8

SECTION 1 SPECIFICATIONS

■ GENERAL

- Frequency coverage : (Unit: MHz)

Version	144 MHz	430 (440) MHz	1200 MHz* ¹
U.S.A.	Tx: 144.0–148.0 Rx: 136.0–174.0* ²	Tx: 430.0–450.0 Rx: 420.0–480.0* ³	Tx: 1240.0–1300.0 Rx: 1240.0–1320.0* ⁴
Europe	144.0–146.0	430.0–440.0	1240.0–1300.0
Australia	144.0–148.0	430.0–450.0	1240.0–1300.0
Korea	144.0–146.0	430.0–440.0	1260.0–1300.0

*¹ Optional UX-910 is installed.

*² Guaranteed range is 144.0–148.0 MHz.

*³ Guaranteed range is 430.0–450.0 MHz.

*⁴ Guaranteed range is 1240.0–1300.0 MHz.

- Mode : USB, LSB, CW, FM, FM-N*
*Not available in 1200 MHz band
- No. of memory Ch. : 212 (99 regular, 6 scan edges, 1 calls for each band) plus 10 satellite memories)
- Antenna connector : SO-239 (50 Ω; VHF)
Type-N (50 Ω; UHF)
- Usable temp. range : –10°C to +60°C; +14°F to +140°F
- Frequency stability : Less than ±3 ppm (–10 to 60°C; +14 to +140°F)
- Frequency resolution : 1 Hz minimum
- Power supply : 13.8 V DC ±15% (negative ground)
- Current drain (at 13.8 V DC) :

Transmit	Max. power	23.0 A
Receive	Standby	2.0 A (3.0 A with UX-910)
	Max. audio	2.5 A (3.5 A with UX-910)
- Dimensions : 241(W) × 94(H) × 239(D) mm
(projections not included) 9½(W) × 3½(H) × 9½(D) in
- Weight (approx.) : 4.5 kg; 10 lb (with UX-910: 5.35 kg; 11 lb 13 oz)
- ACC 1 connector : 8-pin DIN connector
- CI-V connector : 2-conductor 3.5 (d) mm (1/8")
- DATA connectors : 6-pin mini DIN × 2 (for MAIN and SUB)

■ TRANSMITTER

- Output power : (continuously adjustable)

144 MHz	5–100 W
430 (440) MHz	5–75 W
1200 MHz	1–10 W (with UX-910)
- Modulation system : SSB Balanced modulation
FM Variable reactance modulation
- Spurious emission : 144/430 (440) MHz More than 60 dB
1200 MHz More than 50 dB
- Carrier suppression : More than 40 dB
- Unwanted sideband suppression : More than 40 dB
- Microphone connector : 8-pin connector (600 Ω)
- KEY connector : 3-conductor 3.5(d) mm (1/4")

All stated specifications are subject to change without notice or obligation.

■ RECEIVER

- Receive system :

VHF	SSB, CW	Single conversion superheterodyne
	FM	Double conversion superheterodyne
UHF	SSB, CW	Double conversion superheterodyne
	FM	Triple conversion superheterodyne

- Intermediate frequencies : (Unit: MHz)

		MAIN BAND			SUB BAND		
		1st	2nd	3rd	1st	2nd	3rd
144 MHz	SSB	10.8500	—	—	10.9500	—	—
	CW	10.8491	—	—	10.9491	—	—
	FM	10.8500	0.455	—	10.9500	0.455	—
430 (440) MHz	SSB	71.2500	10.8500	—	71.3500	10.9500	—
	CW	71.2491	10.8491	—	71.3491	10.9491	—
	FM	71.2500	10.8500	0.455	71.3500	10.9500	0.455
1200 MHz	SSB	243.9500	10.8500	—	243.9500	10.9500	—
	CW	243.9491	10.8491	—	243.9491	10.9491	—
	FM	243.9500	10.8500	0.455	243.9500	10.9500	0.455

- Sensitivity : SSB, CW (10 dB S/N) Less than 0.11 μ V
 FM (12 dB SINAD) Less than 0.18 μ V
- Squelch sensitivity (threshold) : SSB, CW Less than 1.0 μ V
 FM Less than 0.18 μ V
- Selectivity : SSB, CW More than 2.3 kHz/−6 dB
 Less than 4.2 kHz/−60 dB*
 FM More than 15.0 kHz/−6 dB
 Less than 30.0 kHz/−60 dB*
 FM-N More than 6.0 kHz/−6 dB
 Less than 18.0 kHz/−36 dB
 CW-N More than 0.5 kHz/−6 dB
 (w/FL-132 or FL-133) Less than 1.34 kHz/−60 dB*
 *Except 1200 MHz band
- Spurious and image rejection ratio:

144/430 (440) MHz	More than 60 dB
1200 MHz	More than 50 dB
- AF output power (at 13.8 V DC):
 More than 2.0 W at 10% distortion with an 8 Ω load
- RIT variable range : 144/430 (440) MHz \pm 1.0 kHz (SSB, CW)
 \pm 5.0 kHz (FM)
 1200 MHz \pm 2.0 kHz (SSB, CW)
 \pm 10.0 kHz (FM)
- IF SHIFT variable range : More than \pm 1.2 kHz
- PHONES connector : 3-conductor 6.35(d) mm (1/4")
- Ext. SP connectors : 2-conductor 3.5 (d) mm (1/8") /8 Ω \times 2 (for MAIN and SUB)

SECTION 2 INSIDE VIEWS

2-1 IC-910H

• MAIN AND PLL UNITS

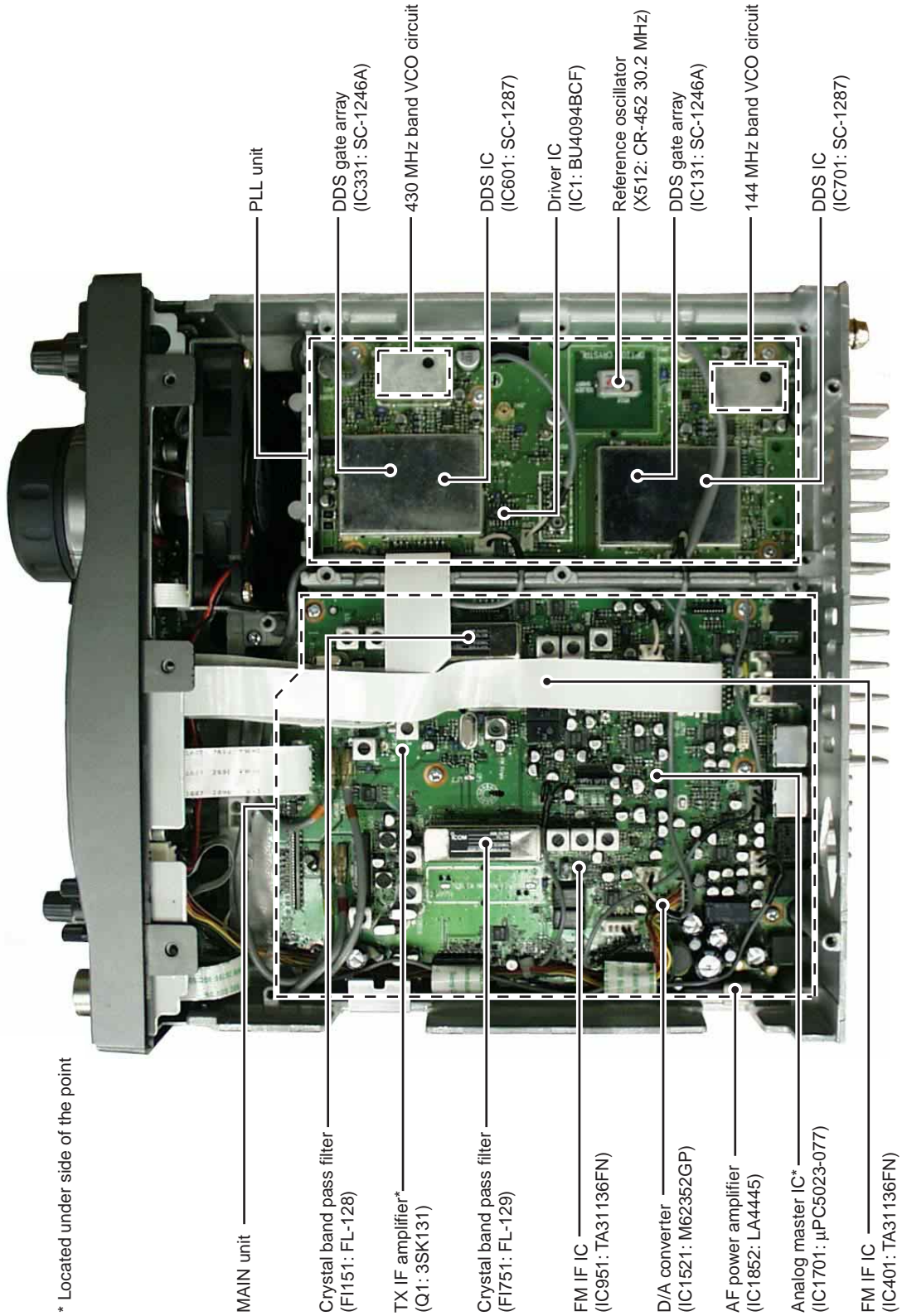

• PA UNIT

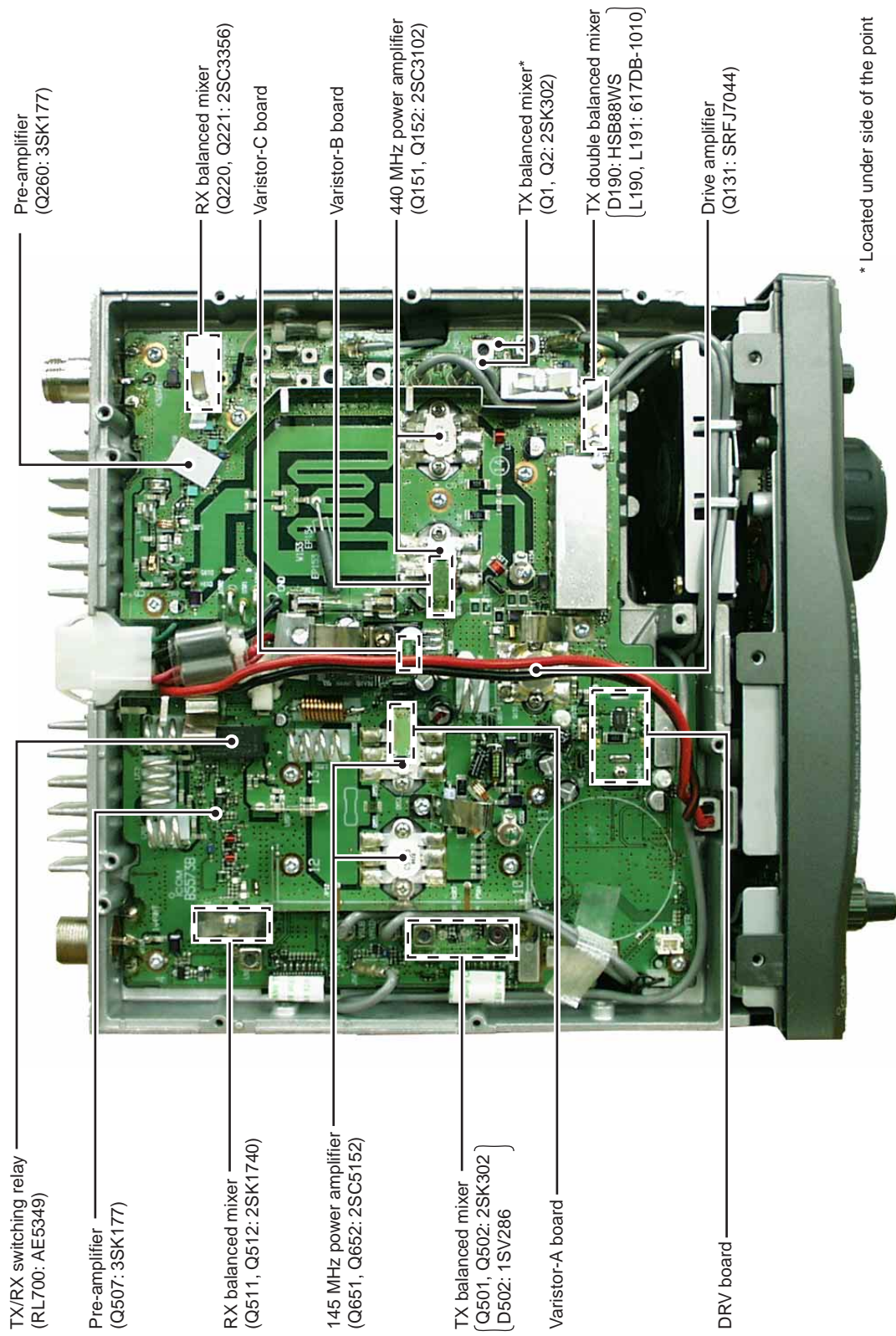

* Located under side of the point

2-2 UX-910 (OPTIONAL UNIT)

• TOP VIEW

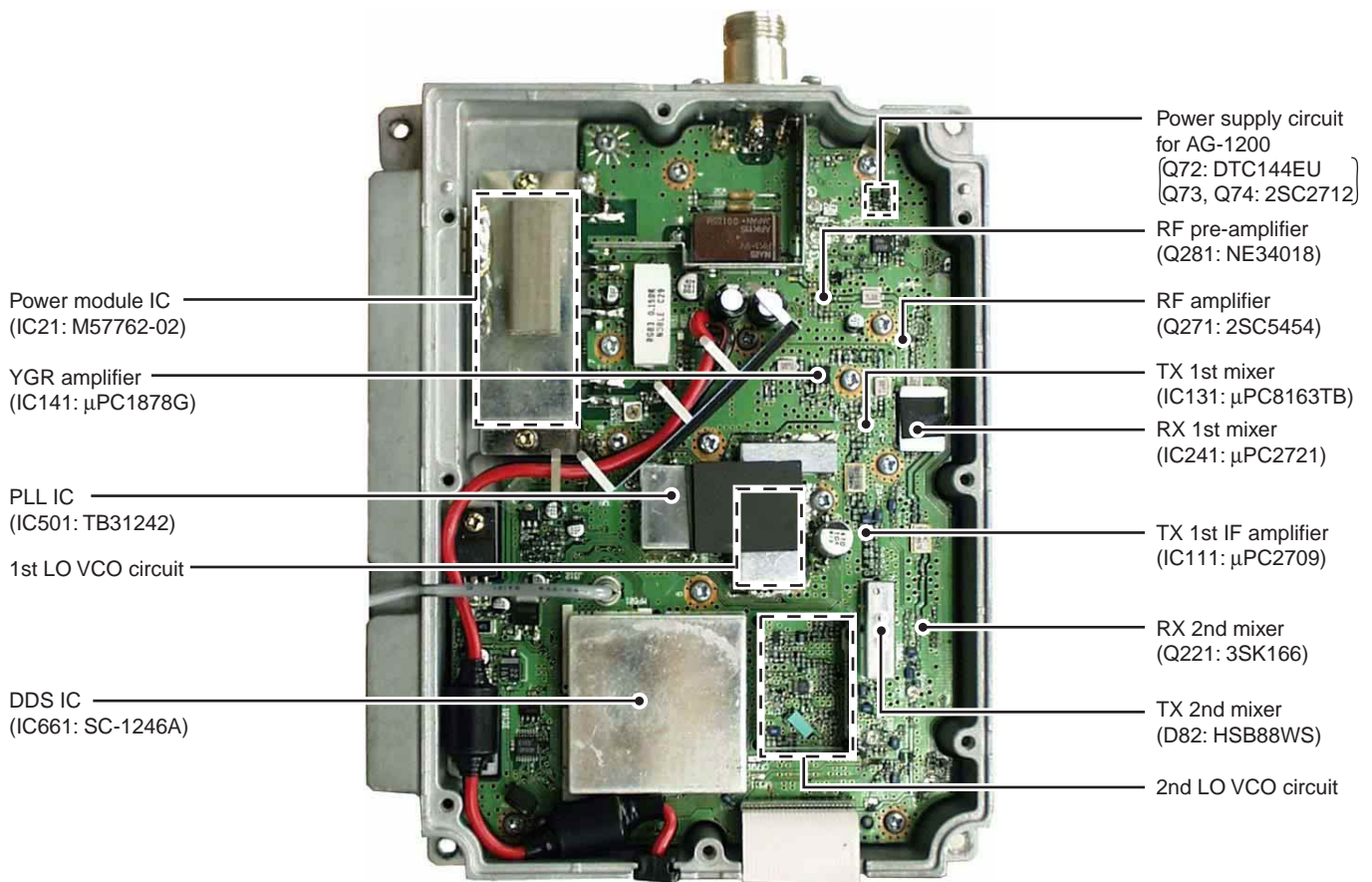

• BOTTOM VIEW

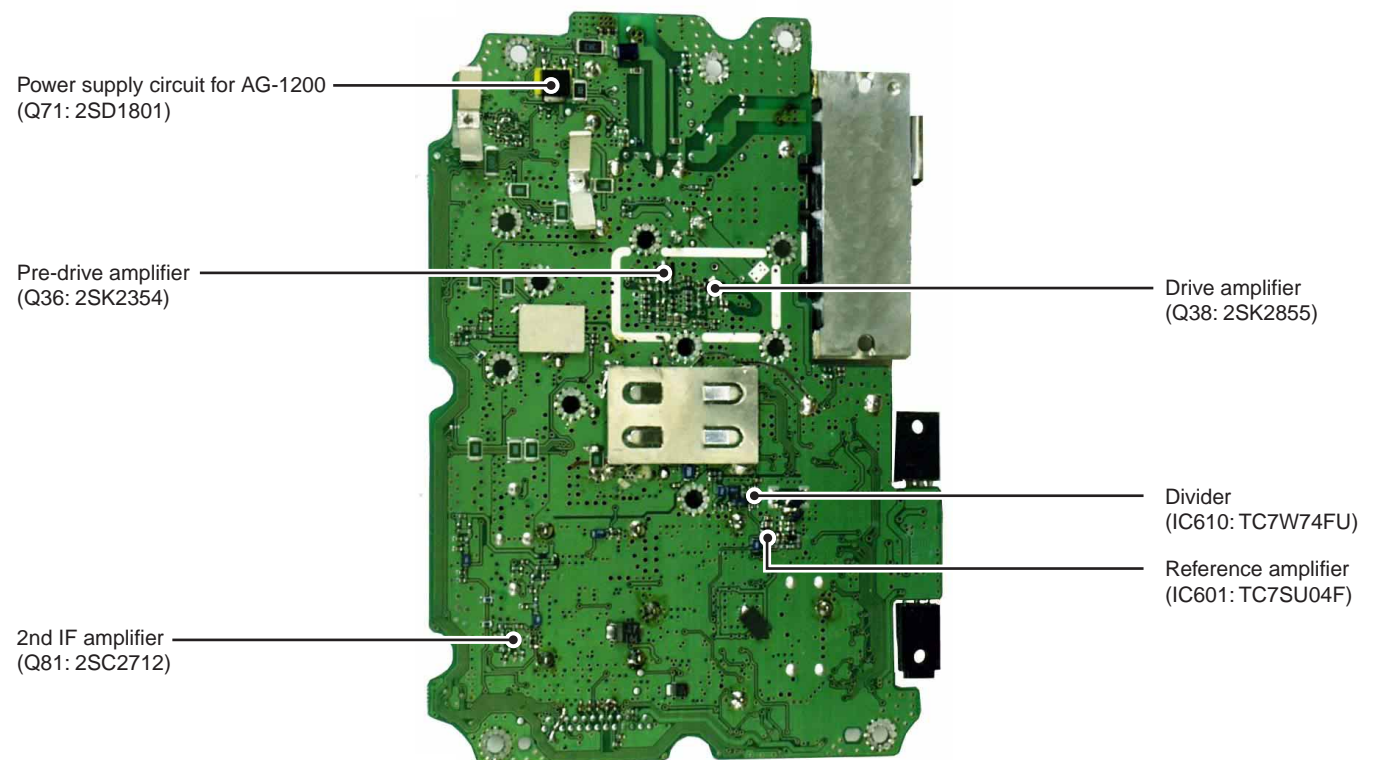

SECTION 3 DISASSEMBLY AND OPTION INSTRUCTIONS

• Opening the transceiver's case

Follow the case and cover opening procedures shown here when you want to install an optional unit or adjust the internal units, etc.

- ① Remove the 5 screws from the top of the transceiver and 4 screws from the sides, then lift up the top cover.
- ② Turn the transceiver upside down.
- ③ Remove 5 screws from the bottom of the transceiver, then lift up the bottom cover.

CAUTION: DISCONNECT the DC power cable from the transceiver before performing any work on the transceiver. Otherwise, there is a danger of electric shock and/or equipment damage.

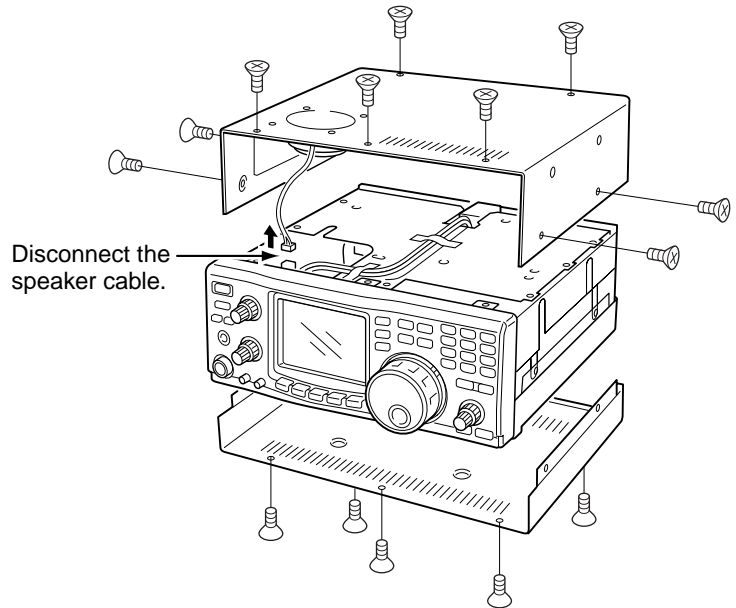

• UX-910 1200MHz BAND UNIT

- ① Remove the bottom cover as shown above.
- ② Remove the antenna plate from the chassis using a standard screw driver.

WARNING!

NEVER attempt to remove the antenna plate using your finger, this may result in injury.

- ③ Connect the FFC (Flexible Flat Cable) of the UX-910 to J2 on the MAIN unit, DC power cable to the power connector (W305) from the PA unit and the coaxial cable to J541 on the PLL unit.

CAUTION

NEVER catch the cables from the optional DSP unit(s) between chassis and the UX-910, this may damage the DSP unit(s) and/or transceiver.

- ④ Place the UX-910 using the supplied 4 screws.

BE CAREFUL not to drop the supplied screws inside the transceiver.

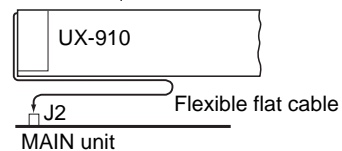
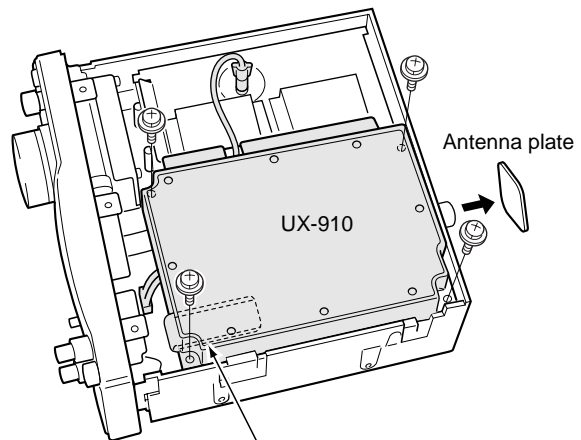
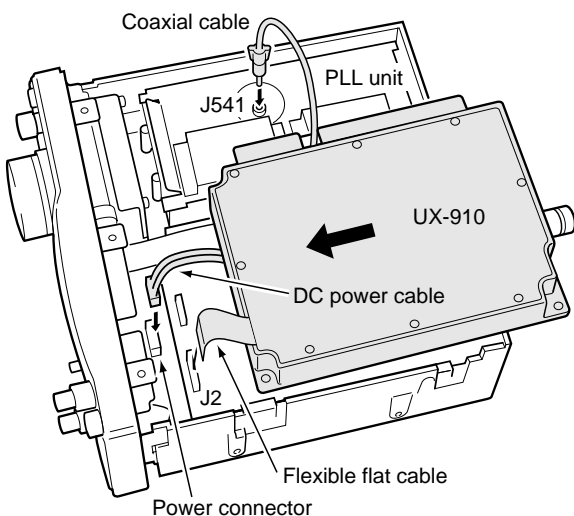

Turn the flexible flat cable up under the UX-910.

- ⑤ Return the bottom cover to its original position.

• Opening the PA unit cover

- ① Remove the top cover as shown in the diagram on p. 3-1.
- ② Remove 8 screws and grounding plate from the PA unit cover.
- ③ Remove fastening tape from the inside power cable.

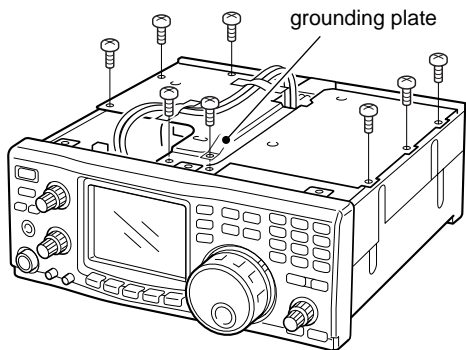

- ④ Slide the PA unit cover as shown below.

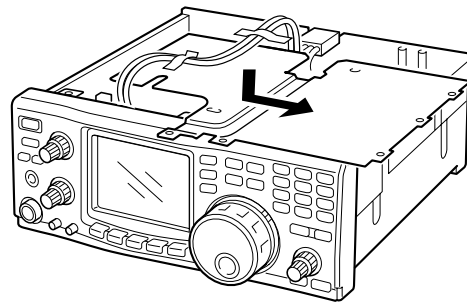

• FL-132/FL-133 CW NARROW FILTER

- ① Remove the bottom cover as shown in the diagram on p. 3-1.
 - Remove the UX-910 if you have installed it. (p. 3-1)
- ② Disconnect the connection cable connectors from J501 and J1051 on the MAIN unit.
- ③ Remove 2 clips.

WARNING!
BE CAREFUL not to pinch your finger with the clip.

- ④ Remove 6 screws from the MAIN unit, then lift up the MAIN unit.

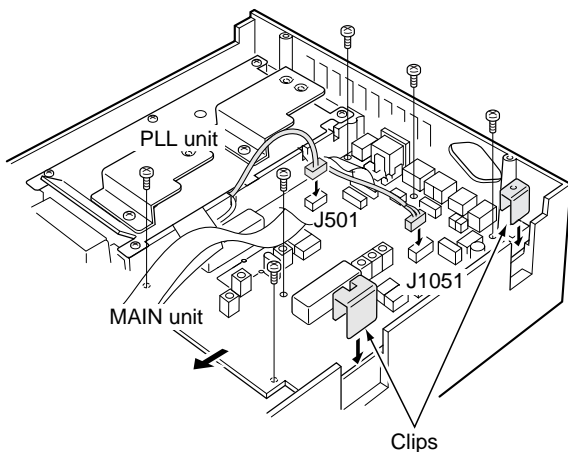

- ⑤ Install FL-132 or FL-133 to the specified position on the MAIN unit.

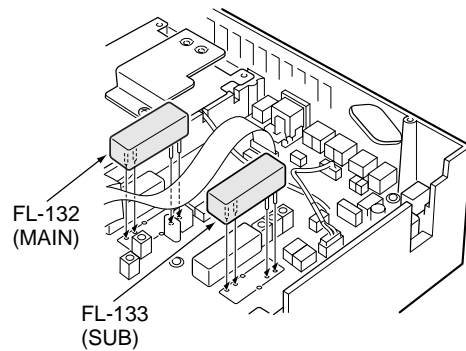

- ⑥ Solder then cut the leads, keeping 2-3 mm (1/8") of the leads from the bottom of the MAIN unit.
- ⑦ Return the MAIN unit and clips to their original positions.
- ⑧ Re-connect the connection cable connector to J501 and J1051 on the MAIN unit.
- ⑨ Return the bottom cover to the original position.

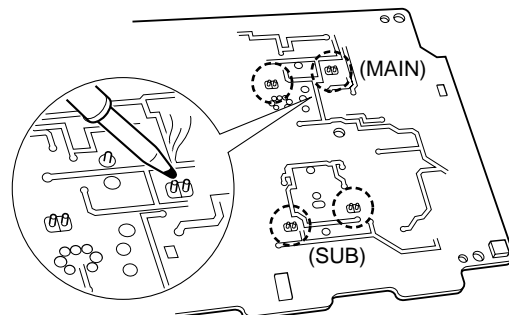

• UT-102 VOICE SYNTHESIZER UNIT

- ① Remove the bottom cover as shown in the diagram on p. 3-1.
 - Remove the UX-910 if you have installed it. (p. 3-1)
- ② Remove the protective paper attached to the bottom of the UT-102 to expose the adhesive strip.
- ③ Plug UT-102 into J1801 on the MAIN unit as shown in the diagram at right.
- ④ Return the bottom cover to its original position.

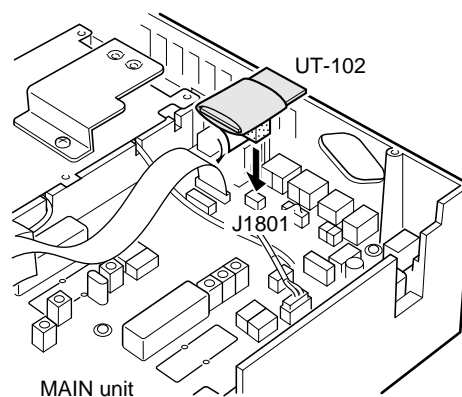

• UT-106 DSP UNIT

RECOMMENDATION:

When installing only 1 DSP unit, you can install into either front or rear panel side. However, installing a DSP unit into the front panel side may be easier and also safer.

Installing 1st DSP unit (front panel side)

- ① Remove the bottom cover as shown in the diagram on p. 3-1.
 - Remove the UX-910 if you have installed it. (p. 3-1)
- ② Remove the shielding plate.
- ③ Remove the connection cable from J1751 on the MAIN unit. Connect the cable into J1 on the UT-106.
- ④ Plug the connection cable (P1) from the UT-106 to J1751 on the MAIN unit.
- ⑤ Plug the flat cable into J3 on the UT-106 and to J1771 on the MAIN unit.
 - Take care of the conductor direction.
 - Attach the Velcro tape to the UT-106 and PLL unit shielding plate.
- ⑥ Return the shielding plate, top cover and bottom cover to their original positions.

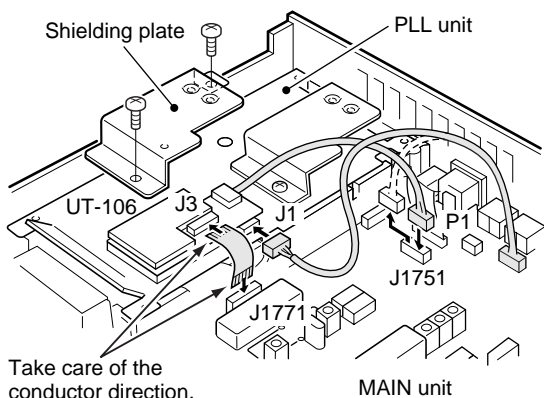

Installing 2nd DSP unit (rear panel side)

- ① Remove the top and bottom cover as shown in the diagram on p. 3-1.
 - Remove the UX-910 if you have installed it. (p. 3-1)
- ② Remove the shielding plate.
- ③ Remove the connection cable from J1761 on the MAIN unit. Connect the cable into J1 on the UT-106.

The cable between J1221 on the MAIN and J1 on the DSP unit, must be set in the groove of the chassis (see diagram below). Otherwise, the cable may be damaged when returning the shield plate to its original position.

- ④ Plug the connection cable (P1) from the UT-106 to J1761 on the MAIN unit.
- ⑤ Plug the flat cable into J3 on the UT-106 and to J1781 on the MAIN unit.
 - Take care of the conductor direction.
 - Attach the Velcro tape to the UT-106 and PLL unit shielding plate.
- ⑥ Return the shielding plate, top cover and bottom cover to their original positions.

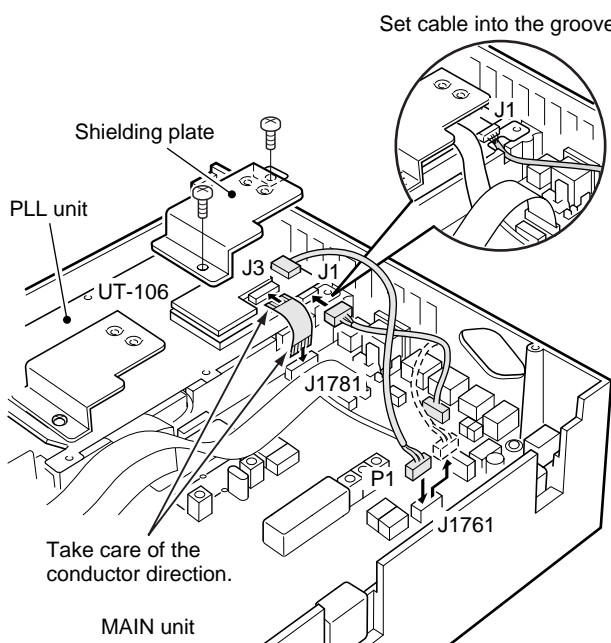

• **CR-293 HIGH STABILITY CRYSTAL UNIT**

- ① Remove the bottom cover as shown in the diagram on p. 3-1.
 - Remove the UX-910 if you have installed it. (p. 3-1)
- ② Remove 6 screws from the PLL shield cover, then lift up the PLL shield cover.

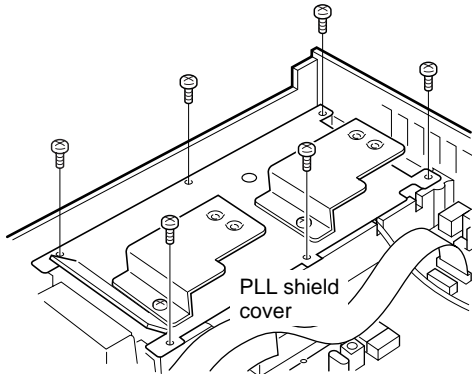

- ⑥ Install the CR-293 and solder the leads.
- ⑦ Return the PLL unit, PLL shield cover and bottom cover to their original positions.

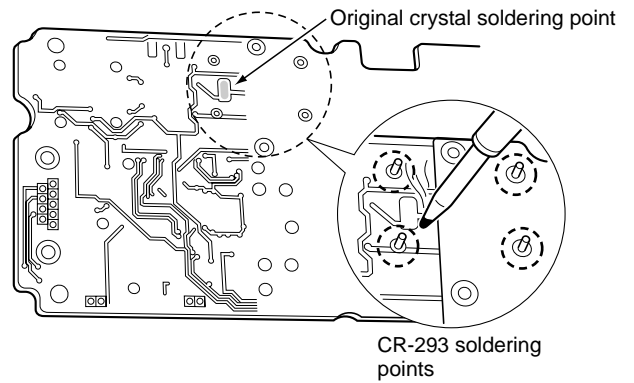

- ③ Disconnect the FFC (Flexible Flat Cable) from the DISPLAY unit and the connection cable connectors from J501 and J1051 on the MAIN unit.
- ④ Remove 5 screws from the PLL unit, then lift up the PLL unit.
- ⑤ Unsolder the original reference crystal, then remove it.
 - The original reference crystal unit is soldered at both top and bottom sides of the PCB (Printed Circuit Board).

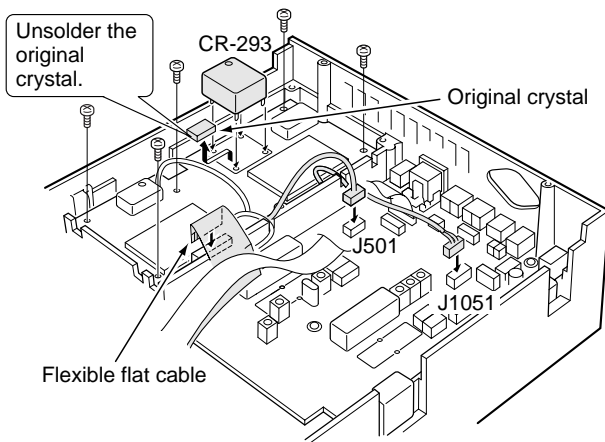

SECTION 4 CIRCUIT DESCRIPTION

4-1 RECEIVER CIRCUIT

Note: [Main]=Main band, [Sub]=Sub band

4-1-1 VHF TRANSMIT/RECEIVE SWITCHING CIRCUIT (PA UNIT)

Received signals from the antenna connector (CHASSIS; J1) are passed through the low-pass filter (L723–L721, C728–C726, C728) then applied to the transmit/receive switching circuit (RL700, D710).

The transmit/receive switching circuit leads receive signal to the RF circuit from a low-pass filter while receiving. However, the circuit leads the transmit signal from the RF power amplifier to the antenna connector while transmitting.

The passed signals are then applied to the RF amplifier circuit.

4-1-2 VHF RF CIRCUIT (PA UNIT)

Received signals from transmit/receive switching circuit are applied to the RF amplifier circuit (Q507) via the RF attenuator (D515), limiter (D514) and tunable band pass filter (D513, L560) circuits.

The amplified signals are then passed through the another three-stage tunable bandpass filters (D512–D510, L13–L15) to suppress unwanted signals. The filtered signals are then applied to the 1st mixer circuit (Q511, Q512).

D510–D513 employ varactor diodes, which are controlled by the CPU (DISPLAY board; IC1) via the D/A converter (MAIN unit; IC1521) and buffer amplifier (MAIN unit; IC1522d), to track the bandpass filter. These varactor diodes tune the center frequency of an RF pass band for wide bandwidth receiving and good image response rejection.

4-1-3 VHF 1ST MIXER CIRCUIT (PA UNIT)

The 1st mixer circuit converts the received signals into a fixed frequency of the 10 MHz IF signal with a PLL output frequency. By changing the PLL frequency, only the desired frequency will pass through a pair of crystal filters at the next stage of the VHF 1st mixer.

The filtered signals from the bandpass filter are mixed with 1st LO signals at the mixer circuit (Q511, Q512) to produce a 1st IF signal (10.85 MHz [Main] or 10.95 MHz [Sub]). The 1st LO signals (125.15 MHz–163.15 MHz) are PLL output frequency, which comes from the VHF VCO circuit (PLL unit; Q191, D191–D194).

The 1st IF signal is then applied to either the Main or Sub band 10 MHz IF circuit in the MAIN unit via P501 [Main] or P510 [Sub].

4-1-4 UHF RF CIRCUIT (PA UNIT)

The received signals from the UHF antenna connector (CHASSIS; J2) are passed through the low-pass filter (L181, L180, C188–C184) and then transmit/receive switching circuit (D182–D185, D265, D266, D227). The signals from the transmit/receive switching circuit are applied to the RF amplifier circuit (Q260) via the RF attenuator circuit (D264) and tunable bandpass filter (D263, L288). The amplified signals are passed through the three-stage tunable bandpass filters (D262–D260, L262–L260), and are then applied to the 1st mixer circuit (Q220, Q221).

4-1-5 UHF 1ST AND 2ND MIXER CIRCUIT (PA UNIT)

The filtered RF signals from the bandpass filter are mixed with a 1st LO signal at the 1st mixer circuit (Q220, Q221) to produce a 1st IF signal (71.25 MHz [Main] or 71.35 MHz [Sub]). The 1st IF signal is passed through a crystal filter (F1280 [Main], F1281 [Sub]) to suppress out-of-band signals. The filtered IF signal is applied to the 2nd mixer circuit (Q11) to produce a 10 MHz IF signal (10.85 MHz [Main] or 10.95 MHz [Sub]) with a 2nd LO signal. The IF signal is then applied to the MAIN unit via P1 [Main] or P30 [Sub].

The 1st LO signal (348.75 MHz–408.75 MHz) is generated at the UHF VCO circuit (PLL unit; Q391, D391–D394), and a 2nd LO signal (60.2 MHz) is produced at the PLL circuit by doubling it's reference frequency (30.2 MHz).

RECEIVER CONSTRUCTION

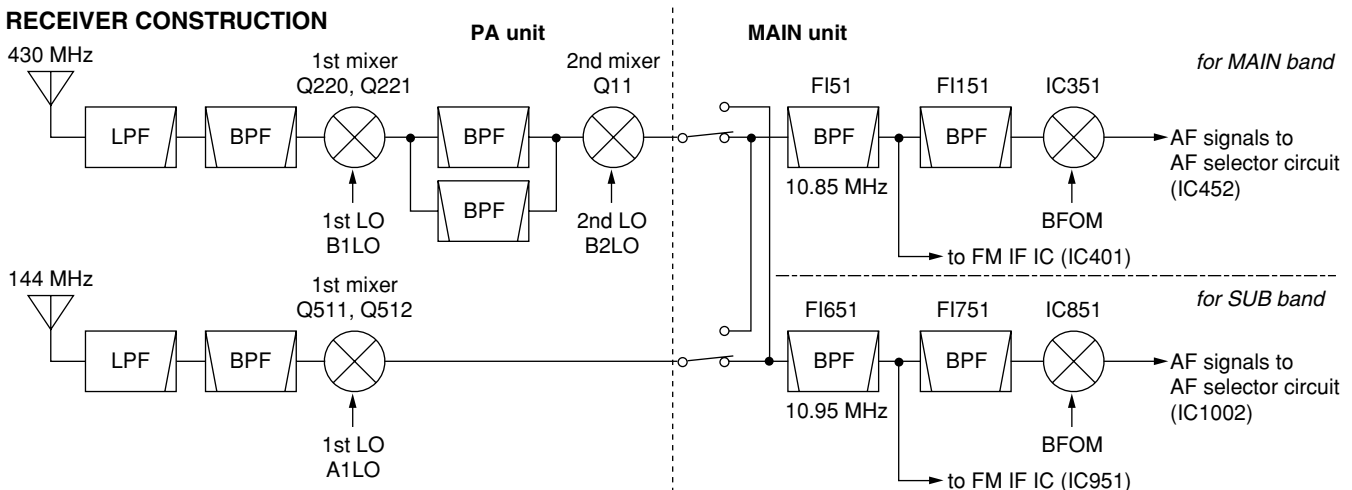

4-1-6 10 MHz IF CIRCUIT (MAIN UNIT)

The 10 MHz IF signal from the mixer circuit is passed through a monolithic filter (F151 [Main], F1651 [Sub]) to suppress out-of-band signals. The filtered signal is amplified at the IF amplifier (Q51 [Main], Q651 [Sub]). The IF amplifier provides 20 dB gain.

The amplified signal is then applied to the different circuits depending on the selected mode.

(1) FM mode

The signal is applied to an FM IF IC pin 16 (IC401 [Main] or IC951 [Sub]).

(2) SSB and CW mode

The signal is passed through a 10 MHz IF filter (F1151/10.85 MHz [Main] or F1751/10.95 MHz [Sub]) or optional CW narrow filters. The filtered signal is amplified at the IF amplifiers (Q350–Q352 [Main] or Q850–Q852 [Sub]) and then applied to a demodulator circuit.

4-1-7 DEMODULATOR CIRCUIT (MAIN UNIT)

(1) FM mode

The 10 MHz IF signal from an IF amplifier (Q51 [Main] or Q651 [Sub]) is applied to the mixer section of the FM IF IC (IC401 [Main], IC951 [Sub], pin 16), and is mixed with a LO signal (10.395 MHz [Main], 10.495 MHz [Sub]) to produce a 455 kHz IF signal. The LO signal is generated by the BFO circuit (PLL unit; IC601 [Main], IC701 [Sub]).

The FM detector circuit employs the quadrature detection method, which uses a ceramic discriminator (X401 [Main], X951 [Sub]) for phase delay to obtain a non-adjusting circuit.

The detected signals are output from pin 9, and applied to the squelch control and center indication detector circuits, etc.

(2) SSB and CW modes

The amplified signal from the IF amplifier circuit (Q51 [Main], Q651 [Sub]) is applied to the balanced mixer circuit (IC351 [Main], IC851 [Sub]) to demodulate into AF signals. Demodulated audio signals are output from pin 1, and applied to the squelch control gate (IC452 [Main], IC1002 [Sub]).

BFO circuit (PLL unit; IC601 [Main] and IC701 [Sub]) generates BFO signals for using in the balanced mixers.

• BFO frequencies

Mode	for MAIN band	for SUB band
USB	10.8485 MHz	10.9485 MHz
LSB	10.8515 MHz	10.9515 MHz
CW	10.8483 MHz	10.9483 MHz

4-1-8 SQUELCH CONTROL CIRCUIT (MAIN UNIT)

The demodulated AF signals from the balanced mixer circuit or FM IF IC are applied to the squelch control gate (IC452 [Main], IC1002 [Sub]). This consists of 4 analog switches which are selected with a mode signal and squelch control signal from the CPU (DISPLAY board; IC1) via the expander IC (IC1491). The switched AF signals are applied to the AF circuit.

4-1-9 SQUELCH CIRCUIT (MAIN UNIT)

(1) FM mode

A squelch circuit cuts out AF signals when no RF signal is received or the S-meter signal is lower than the [SQL] control setting level. By detecting noise components in the AF signals, the CPU switches the squelch control gate.

A portion of the AF signals from the FM IF IC pin 9 (IC401 [Main], IC951 [Sub]) passes through the active filter section of FM IFIC (pin 8). The active filter section amplifies and filters noise components. The filtered signals are applied to the noise detector section for conversion into DC voltage and output from pin 14 (IC401 [Main], IC951 [Sub]) as the “NSQM [Main]/NSQS [Sub]” signal. The “NSQM [Main]/NSQS [Sub]” signal is applied to the DISPLAY board.

The DC voltages are passed through the analog multiplexer (DISPLAY board; IC5, pins 15 and 2) and then applied to the CPU (DISPLAY board; IC1, pins 93, 94) via the MP1Y and MP1X signal lines. The [SQL] level signal is also applied to the CPU via the analog multiplexer (DISPLAY board; IC3, pins 14, 5) as a reference voltage for comparison with the noise signals. Also, an S-meter signal is applied to the CPU from FM IF IC pin 12 (IC401 [Main], IC951 [Sub]) via the meter amplifier (IC1804c [Main], IC1804a [Sub]) and analog multiplexer (DISPLAY board; IC4, pins 12 and 1). The CPU compares these signals, then outputs a control signals to the squelch control gate.

(2) SSB and CW modes

The squelch circuit mutes audio output when the S-meter signal is lower than the [SQL] control setting level.

A portion of the 10 MHz IF signal from the IF amplifier (Q352 [Main], Q852 [Sub]) is converted into DC voltage at the AGC detector (D303, Q305 [Main], D902 Q901 [Sub]) and amplified at the meter amplifier (IC1804d [Main] or IC1804b [Sub]). The amplified signal is passed through the analog multiplexer (DISPLAY board; IC4, pins 12 and 1) via the SMLM [Main]/ SMLS [Sub] signals and then applied to the CPU (DISPLAY board; IC1). The CPU outputs control signals to the squelch control gate when the S-meter signal is low level.

4-1-10 AF AMPLIFIER CIRCUIT (MAIN UNIT)

The AF amplifier circuit amplifies the demodulated signals to drive a speaker. For the separate speaker function, a stereo power amplifier is used.

AF signals from the squelch control gate are passed through the AF filter (IC451a [Main], IC1001a [Sub]) and AF pre-amplifier (IC451b [Main], IC1001b [Sub]) and then amplified at the voltage controlled amplifier (VCA: IC1808 [Main], IC1809 [Sub]) which functions as a volume control using the [AF] control signal. The amplified AF signals are applied to the AF power amplifier circuit (IC1852, pin 2 [Main], pin 5 [Sub]).

The amplified audio signals of SUB band are output from pin 7, and are applied to the external speaker jack for the SUB band (J1852) via the [PHONE] jack (JACK board; J1). When no plug is connected to the jack, the signals are fed back to the MAIN band audio. The mixed audio is applied to the internal speaker via the [PHONE] jack and external speaker jack for the MAIN band (J1851).

4-1-11 NOISE BLANKER CIRCUIT (MAIN UNIT)

The noise blanker circuit detects pulse-type noises, and stops IF amplifier operation during detection.

A portion of the 10 MHz IF signal from the bandpass filter (F151 [Main], F1651 [Sub]) is amplified at the noise amplifier circuit (Q102, IC101, Q101 [Main], Q702, IC701, Q701 [Sub]). The amplified signal is rectified at the noise detector (D371 [Main], D701 [Sub]) for conversion into DC voltage. The DC voltage is amplified at the DC amplifier circuit (Q105 [Main], Q705 [Sub]) and then applied to the noise blanker control circuit (Q52, Q107 [Main], Q652, Q707 [Sub]) to stop amplification of the IF amplifier circuit (Q51 [Main], Q651 [Sub]).

4-1-12 AGC CIRCUIT (MAIN UNIT)

The AGC (Auto Gain Control) circuit reduces IF amplifier gain to keep the audio output at a constant level.

A portion of the 10 MHz IF signal from the IF amplifier (Q352 [Main], Q852 [Sub]) is applied to the AGC detector circuit D303 [Main], D902 [Sub]). The detected signal is then amplified at the DC amplifier circuit (Q305 [Main], Q901 [Sub]) and then applied to the IF amplifiers (Q51, Q351, Q352 [Main], Q651, Q851, Q852 [Sub]).

When strong signals are received, the detected voltage increases and the output level of the DC amplifier, as AGC voltage, decreases. The AGC voltage is used for the bias voltage for the IF amplifiers, therefore, the IF amplifier gain is decreased.

AGC response time is controlled by changing the time constant at the AGC control line with a resistor and capacitor. While AGC is set to slow, the resistor (R312 [Main], R914 [Sub]) and capacitor (C306 [Main], C911 [Sub]) are connected to the AGC control line. While AGC is set to fast, R311 [Main], R913 [Sub] are connected to the AGC control line. Due to Q304 and Q303 [Main]/Q905 and Q904 [Sub] being switched ON that controlled by the "AGSM", "AGFM" [Main], "AGSS", "AGFS" [Sub]. Also, R310 [Main]/R912 [Sub] is connected to the AGC control line due to Q302 [Main]/Q903 being switched ON while scanning for faster response than AGC fast mode that controlled by the "AGRM" [Main], "AGRS" [Sub].

4-1-13 S-METER CIRCUIT (MAIN UNIT)

The S-meter circuit indicates the relative received signal strength while receiving and changes depending on the received signal strength.

(1) FM mode

Some of the amplified IF signal is applied to the S-meter detector section in the FM IF IC (IC401 [Main], IC951 [Sub]) to be converted into DC voltage. The converted signal is output from pin 12 and applied to the meter amplifier circuit (IC1804c [Main], IC1804a [Sub]). The amplified signal is then applied to the CPU (DISPLAY board; IC1) passing through the analog multiplexer (DISPLAY board; IC4, pins 12 and 1) via the "SMLM [Main]/SMLS [Sub]" line. The CPU then outputs S-meter control signal.

(2) SSB and CW modes

A portion of the AGC control signal is applied to the meter amplifier (IC1804d [Main], IC1804b [Sub]). The amplified signal is then applied to the CPU via the analog multiplexer to control the S-meter.

4-2 TRANSMITTER CIRCUITS

4-2-1 MICROPHONE AMPLIFIER CIRCUIT (MAIN UNIT)

The microphone amplifier circuit amplifies audio signals from the microphone or ACC connector and then applies them to the FM modulation or balanced modulator circuit. One microphone amplifier circuit is commonly used for both FM/SSB and VHF/UHF.

Audio signals from the [MIC] connector enter the microphone amplifier IC (IC1701, pin 22) and are then amplified at the microphone amplifier or speech compressor section. Compression level is adjusted by the setting mode.

The amplified or compressed signals are applied to the VCA section of IC1701. The microphone gain setting from the D/A converter (IC1521, pin 8) is applied to the VCA control terminal (IC1701, pin 10). The resulting signals from pin 9 are then applied to the buffer-amplifier (Q1651) via the analog switch (IC1653a). External modulation input from the [ACC] socket (pin 4) is also applied to Q1651.

• AGC CIRCUIT FOR MAIN BAND

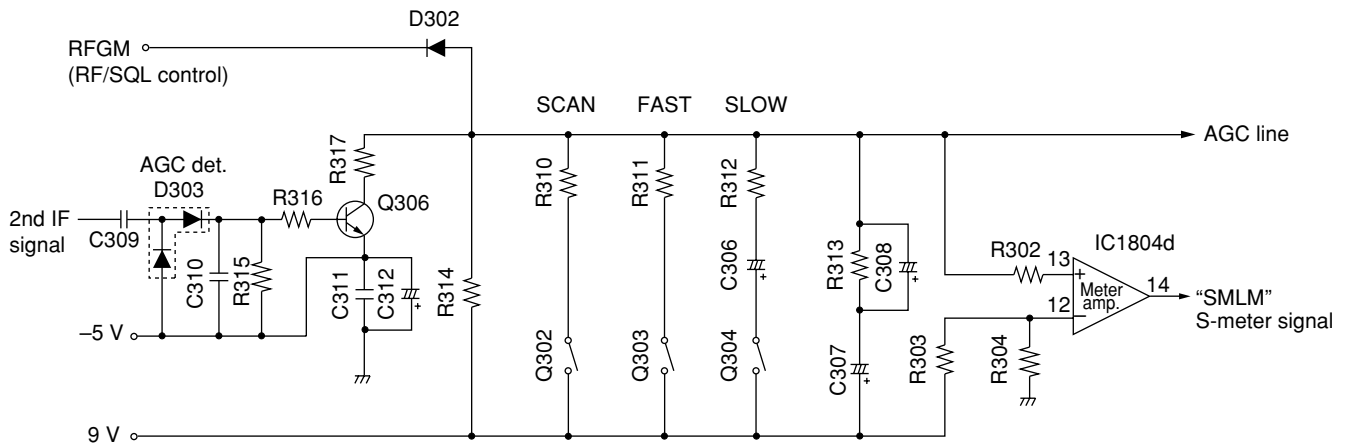

While in SSB mode, the amplified signals from the buffer amplifier (Q1651) are then applied to the balanced modulator (IC201).

While in AM/FM mode, the amplified signals from the buffer amplifier (Q1651) are applied to the limiter amplifier (IC1651b) and splatter filter (IC1651a). The signals are passed through the buffer amplifier (IC1652a) and are then applied to the AM detector (IC1807d, D1652) in AM mode or to the varactor diode (D253) in FM mode.

4-2-2 MODULATION CIRCUIT (MAIN UNIT)

(1) FM mode

The amplified audio signals from IC1701 are pre-emphasized and limited at IC1651b and then passed through the splatter filter (IC1651a). The filtered signals are then applied to the FM modulation circuit (D253) via the FM deviation level controller (IC1803 pins 21, 22) and buffer amplifier (IC1652a). Also, subaudible tone signals from the CPU (DISPLAY board; IC1 pin 4) are applied to the FM modulation circuit (D253) via the splatter filter (IC1651a).

The FM modulation circuit changes the generating frequency of the FM local oscillator (Q254, X251) to generate an FM signal. The modulated IF signal is passed through the RF limiter (Q253) and then applied to the transmit IF amplifier circuit.

When 9600 bps mode is selected, audio signals from the ACC connector bypass the amplifiers and are applied to IC1654a directly via the external modulation switch (IC1531, pins 12, 1). In such cases, the deviation detector (IC1807d) cuts off the audio line when over modulation is detected.

(2) SSB and CW modes

The amplified audio signals from Q1651 are mixed with BFO signals at the balanced mixer circuit (IC201) to produce a 10 MHz IF signal. The mixed signal is still a DSB signal, therefore, the mixed signal passes through bandpass filter circuit (FI151) to suppress unwanted side band signals. The filtered signal is applied to the transmit IF amplifier circuit

• Transmit IF frequencies

Mode	Transmit IF signal
USB	10.8485 MHz
LSB	10.8515 MHz
CW	10.8491 MHz

4-2-3 CW KEYING CIRCUIT (MAIN UNIT)

When the CW key is closed, control signal is output from CPU (LOGIC unit) and controls break-in operation, the side tone signal.

Keying signals (DOT and DASH) from the [KEY] jack (J1401) are applied to the CPU (DISPLAY board; IC1, pins 49, 48 respectively), and the CPU outputs a CW control signal (KDS1) from pin 21. The CW control signal is applied to the balanced mixer (IC201) via Q201, D201, D207 to unbalance the IC201 input bias voltage and creates a carrier signal. R202 determines the transmit delay timing.

4-2-4 TRANSMIT IF AMPLIFIER CIRCUIT (MAIN UNIT)

The modulated IF signal from a modulation circuit is applied to the IF amplifier circuit (Q1). The amplified IF signal is then applied to the VHF/UHF transmit circuit (PA unit) via the VHF/UHF switching circuit (D52, D53).

The gain of the IF amplifier circuit (Q1) is controlled by the ALC amplifier circuit (IC1601b). Therefore, the IF amplifier is reduced when the output power increases.

4-2-5 RF CIRCUIT (PA UNIT)

The RF circuit consists of mixer and drive amplifiers to obtain the desired frequency and level needed at a PA circuit, respectively.

(1) VHF band

The IF signal from the MAIN unit (P501) is mixed with an LO signal from the VHF VCO circuit (PLL unit; Q191, D191–D194) at the double-balanced mixer circuit (Q501, Q502, D502) to be converted into VHF transmit frequency. The mixed signal is passed through the attenuator (R512–R514) and two-stage tunable bandpass filter (D503, L533 and D504, L504) to suppress spurious components. The filtered signals are then amplified at the YGR amplifier (IC501) and passed through the attenuator (R562–R531) and another two-stage tunable bandpass filter (D641, L641 and D642, L642)

The amplified and filtered RF signal is applied to the drive amplifier circuit that is used VHF and UHF signals commonly.

(2) UHF band

The IF signal from the MAIN unit (P1) is mixed with a 2nd LO signal at the double-balanced mixer circuit (Q1, Q2) to produce a 2nd IF signal (71.25 MHz). The 2nd LO signal (60.4 MHz) is generated at the reference oscillator and doubler circuit (PLL unit; X512, Q551) via LO amplifier (IC40). The 2nd IF signal is amplified at the buffer amplifier (Q3) via the bandpass filter circuit (L3, L4, C12, C13, C15–C17, C24, C26). The amplified 2nd IF signal is applied to the 1st mixer circuit (D190, L190, L191) passing through the attenuator (R12–R14) and low-pass filter (L381, L382, C381–C383).

The 1st mixer circuit (D190, L190, L191) converts the 2nd IF signal into a UHF transmit frequency with a 1st LO signal from the UHF VCO circuit (PLL unit; Q391, D391–D394). The converted RF signal is passed through the bandpass filter (FI200 and FI201) where unwanted LO signal emission is reduced. The filtered signal is attenuated at R204–R206 and amplified at the YGR amplifier (IC200), and is then applied to the drive amplifier circuit via the band pass filter (FI202) and another YGR amplifier (Q200).

4-2-6 DRIVE AMPLIFIER CIRCUIT (PA UNIT)

The drive amplifier circuit amplifies RF signals from the VHF or UHF RF circuit to obtain a level needed at the power amplifier circuit. One drive amplifier circuit is commonly used for both VHF and UHF band signals.

The signals from the VHF or UHF RF circuit are amplified at the drive amplifier circuit (Q101, Q121, Q131, DRV board; Q930). The amplified VHF signals are passed through the

low-pass filter and UHF signal are high-pass filter, and then applied to the VHF and UHF power amplifier circuit separately.

4-2-7 POWER AMPLIFIER CIRCUIT (PA UNIT)

The power amplifier circuit amplifies the RF signals to the specified output power.

(1) VHF power amplifier circuit

The RF signal from the low-pass filter circuit is applied to the VHF power amplifier circuit (Q651, Q652) to obtain a stable 100 W of RF output power. The amplified RF signal is applied to the antenna connector (CHASSIS; J1) via the power detector (D720, D721), transmit/receive switching relay (RL700) and low-pass filter (L723–L721, C728–C726, C728) circuits.

(2) UHF power amplifier circuit

The RF signal from the high-pass filter is applied to the UHF power amplifier circuit (Q151, Q152) to obtain a stable 75 W of RF output power. The amplified RF signal is applied to the antenna connector (CHASSIS; J2) via the transmit/receive switching circuit (D182–D185), low-pass filter (L181, L180, C188–C184) and power detector (D180, D181) circuits.

4-2-8 ALC CIRCUIT (PA AND MAIN UNITS)

The ALC (Automatic Level Control) circuit protects the power amplifiers (PA unit; Q651, Q652 for VHF and Q151, Q152 for UHF) from a mismatched output load. Also, the ALC circuit controls the gain of the transmit IF amplifier in order for the transceiver to output even when the supplied voltage shifts, etc.

The RF power level is detected at the power detector circuit (PA unit; D720–D721 for VHF, D180, D181 for UHF) to be converted into DC voltages. The detected voltage (VFOR for VHF or UFOR for UHF) is passed through the switching diode, and are then applied to the differential amplifier (MAIN unit; IC1601b) via the FOR line. A reference voltage (POCV) for IC1601b is controlled by the [RF PWR] control to output reference voltages. The output voltage is applied to the transmit IF amplifier circuit (MAIN unit; Q1) as an ALC signal to control the amplifier gain.

When the VFOR/UFOR voltage increased, the output from the differential amplifier will be decrease to reduce the IF amplifier gain. This adjusts the RF output power until the VFOR/UFOR and POCV voltage are well balanced.

4-2-9 APC CIRCUIT (MAIN UNIT)

The APC (Automatic Power Control) circuit protects the power amplifiers on the PA unit from excessive current.

Current drain of power amplifiers is detected by voltage drops at a resistor (PA unit; R305) between VCC and PAHV lines. The original voltage (ICH) and dropped voltage (ICL) are applied to the APC differential amplifier (MAIN unit; IC1601d).

The signal output from the differential amplifier reduces IF amplifier gain until these voltages are well-balanced.

4-3 PLL CIRCUITS

IC-910H contains 2 PLL circuits and 1 local oscillator. The VHF and UHF PLL circuits adopt "Icom's original I-loop PLL" to obtain very fast lock up times.

4-3-1 VHF PLL CIRCUIT (PLL UNIT)

The VHF PLL circuit generates the 1st LO frequency, and the signal is applied to the VHF 1st mixer circuit in the PA unit as the "A1LO" signal. The PLL circuit consists of a VCO, prescaler and DDS circuits.

The signal generated at the VHF VCO circuit (Q191, D191–D194) is amplified at the buffer amplifiers (Q192, Q272), then applied to the prescaler circuit (IC271). The prescaler circuit divides the applied signal, and outputs it to the VHF DDS circuit (IC131) via the buffer amplifier (Q271). The VHF DDS circuit generates digital signals using the applied signals as a clock frequency. The phase detector section in IC131 compares its phase with the reference frequency that is generated at the reference oscillator (X512). IC131 outputs off-phase components as pulse signals via pins 51, 52.

The output pulses are converted into DC voltage at the loop filter circuit (IC161a) and then applied to the VHF VCO circuit.

The D/A converter (R101–R124), low-pass filter (L101–L103, C103–C110) and buffer amplifier (IC101) circuits are connected to the DDS output to convert the digital oscillated signals into smooth analog signals.

4-3-2 UHF PLL CIRCUIT (PLL UNIT)

The UHF PLL circuit generates the 1st LO frequency, and the signal is applied to the UHF 1st mixer circuit in the PA unit as the "B1LO" signal. The PLL circuit consists of a VCO, prescaler and DDS circuits.

The signal generated at the UHF VCO circuit (Q391, D391–D394) is amplified at the buffer amplifiers (Q392, Q472), then applied to the prescaler circuit (IC471). The prescaler circuit divides the applied signal, and outputs it to the UHF DDS circuit (IC331) via the buffer amplifier (Q471).

The D/A converter (R301–R324), low-pass filter (L301–L303, C103–C311) and buffer amplifier (IC301) circuits are connected to the DDS output to convert the digital oscillated signals into smooth analog signals.

4-4 UX-910 (1200 MHz BAND UNIT)

UX-910 is an optional 1200 MHz band unit for IC-910H. This unit covers 1240–1300 MHz frequency range.

4-4-1 ANTENNA SWITCHING CIRCUIT (for RX)

Received signals from the antenna connector (CHASSIS; J501) are applied to the transmit/receive switching circuit (RL51).

The transmit/receive switching circuit leads receive signal to the RF circuit while receiving. However, the circuit leads the transmit signal from the RF power amplifier to the antenna connector while transmitting.

The passed signals are then applied to the RF amplifier circuit.

4-4-2 1200 MHz RF CIRCUIT (for RX)

Received signals from the transmit/receive switching circuit are passed through the high-pass filter (L285–L287, L289, C297–C300) and pre-amplifier (Q281) and are applied to the RF amplifier circuit (Q271) via the band pass filter circuit (FI281).

The amplified signals are then passed through the another bandpass filter (FI271) to suppress unwanted signals. The filtered signals are then applied to the 1st mixer circuit (IC241).

4-4-3 1200 MHz 1ST/2ND MIXER CIRCUITS (for RX)

The 1st/2nd mixer circuits convert the received signals into a fixed frequency of the 10 MHz IF signal with a PLL output frequencies. By changing the PLL frequency, only the desired frequency will pass through a filter at the next stage.

The filtered signals from the bandpass filter are mixed with 1st LO signals at the mixer circuit (IC241) to produce a 1st IF signal (243.95 MHz). The 1st LO signals (996.0 MHz–1076.1 MHz) are PLL output frequency, which comes from the 1st LO VCO circuit (Q451, Q452).

The 1st IF signal is passed through the bandpass filter (FI241) to suppress unwanted signals, and then applied to the 2nd mixer circuit (Q221).

The applied signal is mixed with 2nd LO signal coming from the 2nd LO VCO circuit (Q731) to produce a 10.85 MHz [Main], 10.95 MHz [Sub] 2nd IF signal. The 2nd IF signal is passed through the main/sub switching circuit (Q161, Q164), and then output to the MAIN unit of IC-910H via J311 (pin 25 [Main], pin 1 [Sub]).

4-4-4 IF AMPLIFIER CIRCUIT (for TX)

The modulated 2nd IF signal from IC-910H via J311 is amplified at the 2nd IF amplifier (Q81), and is passed through the low-pass filter (L82, L83, C80, C85–C89) to suppress unwanted signals. The filtered signal is then applied to the 2nd mixer circuit.

The applied signal is mixed at the 2nd mixer circuit (D82, L84, L85) to converted into the 1st LO signal with the 2nd LO signal, which comes from the 2nd LO VCO (Q731).

Then the 1st LO signal is passed through the low-pass filter (L121, L122, C121–C125) and amplified at the 1st IF amplifier (IC111). The amplified signal is passed through the bandpass filter (FI101) between the attenuators (R104–R106) and (R133–R135), and are then applied to the 1st mixer circuit (IC131).

The signal is mixed with the 1st LO signal coming from the 1st LO VCO circuit (Q451, Q452) to converted into RF signals.

4-4-5 DRIVE/POWER AMPLIFIER CIRCUITS (for TX)

The RF signals from the 1st mixer circuit are passed through the bandpass filter (FI141) and low-pass filter (L141, L142, C142–C146), and then amplified at the YGR amplifier circuit (IC141).

The amplified signals are passed through the bandpass filter (FI1) to suppress spurious components, and are amplified at the pre-drive amplifier (Q36, Q38) and power module (IC21) to obtain a stable 10 W of output power.

The output signals from the power module (IC21) are passed through the duplexer circuit (RL51) and detector circuits of forward voltage and reflected voltage, and are then applied to the antenna connector.

4-4-6 PLL CIRCUITS

UX-910 contains 2 frequency synthesizer circuit. This unit does not have a local oscillator circuit and uses a 30.2 MHz frequency from IC-910H as a reference frequency. The 2nd LO circuit adopt "Icom's original I-loop PLL" to obtain 1 Hz pitch fine tuning.

The reference frequency from the IC-910H via J312 is amplified at the reference amplifier (IC601, Q601) and applied to the 2LO DDS IC (IC661). A portion of the reference signal is also applied to the divider circuit (IC610). The divided signal is applied to the 1LO PLL circuit (IC501).

4-4-7 1LO PLL CIRCUIT

The 1LO PLL circuit generates the 1st LO frequency, and the signal is applied to the 1st mixer circuit as the "1LO" signal.

An oscillated signal from the 1LO VCO (Q541, Q542) passes through the buffer amplifiers (Q551, Q681) and is applied to the PLL IC (IC501, pin 1) and is prescaled in the PLL IC based on the divided ratio (N-data). The reference signal is also applied to the PLL IC (IC501, pin 6). The PLL IC detects the out-of-step phase using the reference frequency and outputs it from pin 10. The output signal is passed through the active filter (IC502, Q511, Q512) and is then applied to the 1LO VCO circuit as the lock voltage.

4-4-8 2LO PLL CIRCUIT

The 2LO PLL circuit generates the 2nd LO frequency, and the signal is applied to the 2nd mixer circuit as the "2LO" signal.

The signal generated at the 2LO VCO circuit (Q731) is amplified at the buffer amplifiers (Q741, Q761), then applied to the prescaler circuit (IC761). The prescaler circuit divides the applied signal, and outputs it to the DDS circuit (IC661) via the buffer amplifier (Q762). The DDS circuit generates digital signals using the applied signals as a clock frequency. The phase detector section in IC661 compares its phase with the reference frequency from the reference amplifier (IC601). IC661 outputs off-phase components as pulse signals via pins 51, 52.

The output pulses are converted into DC voltage at the loop filter circuit (IC701a) and then applied to the 2LO VCO circuit.

The D/A converter (R621–R645), low-pass filter (L651–L653, C651–C657) and buffer amplifier (IC621) circuits are connected to the DDS output to convert the digital oscillated signals into smooth analog signals.

SECTION 5 ADJUSTMENT PROCEDURES

4-1 PREPARATION BEFORE SARVICING

■ REQUIRED TEST EQUIPMENT

EQUIPMENT	GRADE AND RANGE	EQUIPMENT	GRADE AND RANGE
DC power supply	Output voltage : 13.8 V DC Current capacity : 30 A or more	Audio generator	Frequency range : 300–3000 Hz Measuring range : 1–500 mV
RF power meter (terminated type)	Measuring range : 1–150 W Frequency range : 120–1500 MHz Impedance : 50 Ω SWR : Less than 1.2 : 1	Standard signal generator (SSG)	Frequency range : 0.1–1500 MHz Output level : 0.1 μV–32 mV (–127 to –17 dBm)
Frequency counter	Frequency range : 0.1–100 MHz Frequency accuracy : ±0.5 ppm or better Sensitivity : 100 mV or better	AC millivoltmeter	Measuring range : 10 mV–10 V
RF voltmeter	Frequency range : 0.1–500 MHz Measuring range : 0.01–10 V	DC voltmeter	Input impedance : 50 kΩ/V DC or better
FM deviation meter	Frequency range : DC–500 MHz Measuring range : 0 to ±5 kHz	DC ammeter	Measurement capability: 1 A/30 A
Distortion meter	Frequency range : 1 kHz ±10 % Measuring range : 1–100 %	Spectrum analyzer	Frequency range : At least 150 MHz Spectrum bandwidth : 100 kHz or more
Oscilloscope	Frequency range : DC–20 MHz Measuring range : 0.01–20 V	Attenuator	Power attenuation : 50 or 60 dB Capacity : 150 W or more
Digital multimeter	Input impedance : 10 MΩ/DC or better	External speaker	Input impedance : 8 Ω Capacity : 5 W or more
		Terminator	Resistance : 50 and 150 Ω Capacity : 150 W or more

■ CONNECTIONS

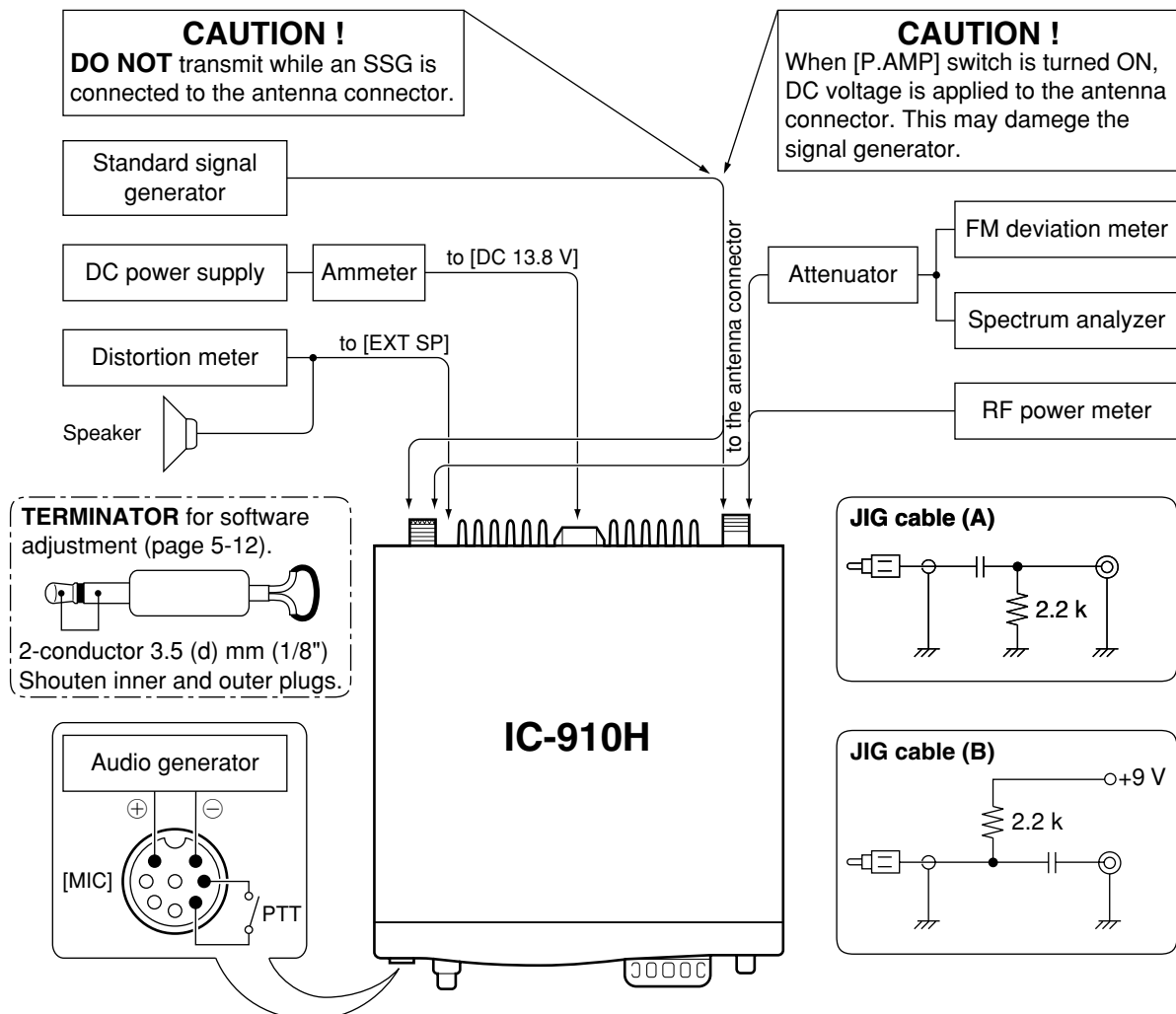

5-2 PLL ADJUSTMENTS

ADJUSTMENT	ADJUSTMENT CONDITION	MEASUREMENT		VALUE	ADJUSTMENT POINT	
		UNIT	LOCATION		UNIT	ADJUST
30.2 MHz LEVEL	1 • Display frequency: Any • Receiving	PLL	Connect an RF voltmeter or spectram analyzer to check point J541.	-10 dBm (or more than -11.5 dBm, when R570 is in maximum position.)	PLL	R570
REFERENCE FREQUENCY	1 • Display frequency: Any • Receiving	PLL	Connect an RF voltmeter or spectram analyzer to check point P551.	Maximum level (-13 dBm to -7dBm)	PLL	Adjust in sequence L551, L552 several times.
	2 This adjustment must be performed at 5 minutes later after power ON.		Connect a frequency counter to check point P551.	60.400000 MHz		The trimmer capacitor of X512.
144M LOCK VOLTAGE	1 • Display frequency: 173.9800 MHz • Mode : USB • Receiving	PLL	Connect a digital multimeter or oscilloscope to check point CP100.	2.7 V	PLL	L193
	2 • Display frequency: 136.0200 MHz • Receiving			0.6 V to 1.6 V		Verify
	3 • Display frequency: 155.0000 MHz • Receiving		Connect an RF voltmeter to check point P251.	-10 dBm to -4 dBm		Verify
440M LOCK VOLTAGE	1 • Display frequency: 479.9800 MHz • Mode : USB • Receiving	PLL	Connect a digital multimeter or oscilloscope to check point CP300.	3.4 V	PLL	C402
	2 • Display frequency: 420.0200 MHz • Receiving			0.5 V to 1.5 V		Verify
	3 • Display frequency: 450.0000 MHz • Receiving		Connect an RF voltmeter to check point P421.	-16 dBm to -10 dBm		Verify
MAIN BFO LEVEL	1 • Display frequency: Any • Mode :USB • Receiving	PLL	Connect an RF voltmeter to check point P601.	-11 dBm to -5 dBm	PLL	Verify
SUB BFO LEVEL	2 • Sub display freq. : Any • Mode :USB • Receiving	PLL	Connect an RF voltmeter to check point P701.	-11 dBm to -5 dBm	PLL	Verify

5-3 FREQUENCY ADJUSTMENT

ADJUSTMENT	ADJUSTMENT CONDITION	MEASUREMENT		VALUE	ADJUSTMENT POINT	
		UNIT	LOCATION		UNIT	ADJUST
FM TX-LO FREQUENCY	1 • Display frequency: Any • Mode : FM • Disconnect P501, P502 (PA unit) from J51 and J52 on the MAIN unit. • Apply no audio signals to [MIC] connector. • Transmitting	MAIN	Connect a frequency counter to check point CP51.	10.85000 MHz	MAIN	L255
After adjustment, connect P501, P502 (PA unit) to J51, J52 on the MAIN.						

• PLL AND MAIN UNITS

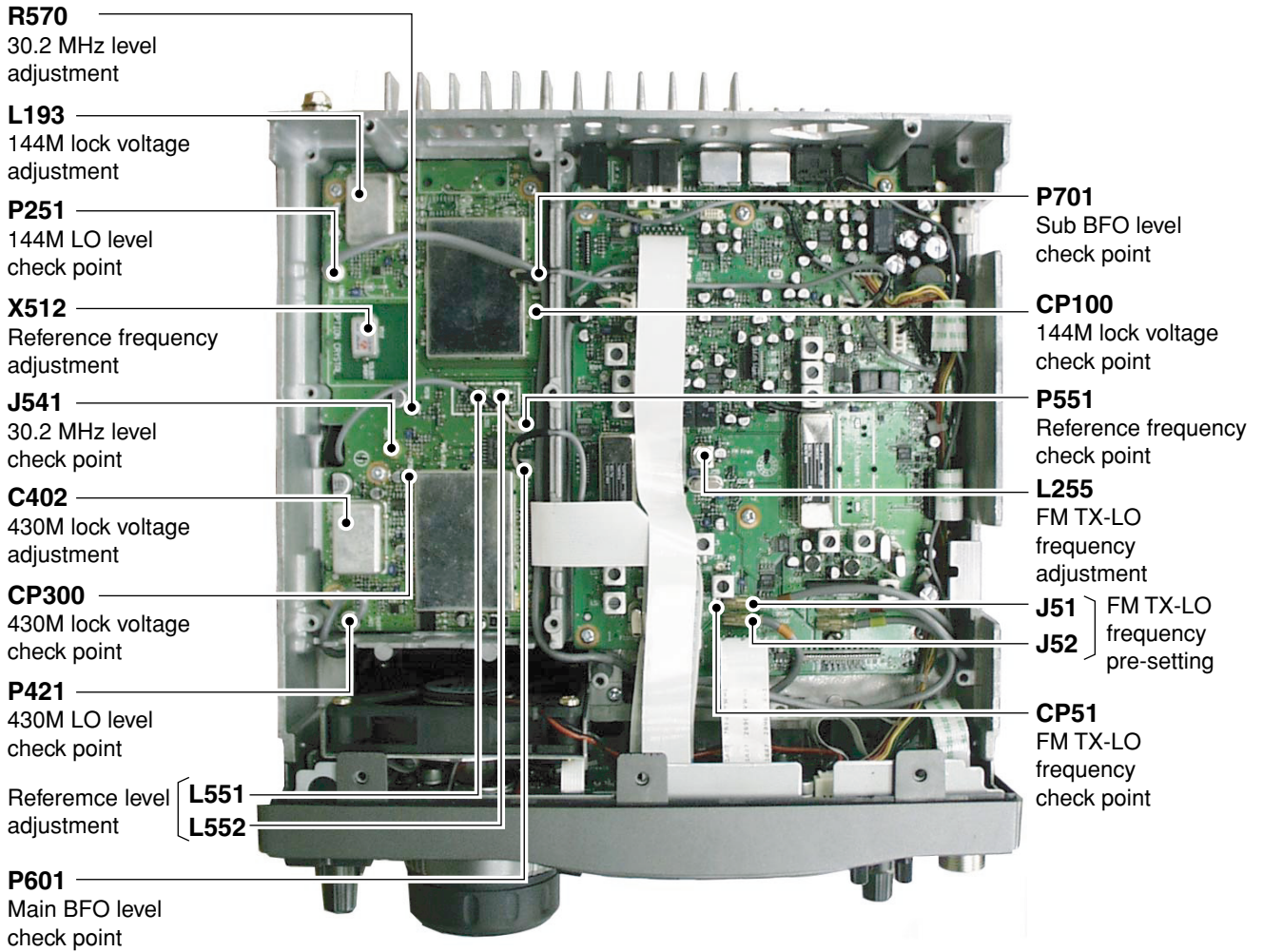

5-4 RECEIVER ADJUSTMENTS

Receiver adjustments must be performed after software adjustment (0) and (1). SUB band must be OFF when adjusting MAIN band, or main AF volume (max. counter clockwise) and SQL volume (max. clockwise) must be set when adjusting SUB band.

ADJUSTMENT	ADJUSTMENT CONDITION	MEASUREMENT		VALUE	ADJUSTMENT POINT		
		UNIT	LOCATION		UNIT	ADJUST	
144 M RECEIVER PEAK/GAIN	1	<ul style="list-style-type: none"> • Display frequency: Any • Disconnect P501 (PA unit) from J51 on the MAIN unit. • Connect a standard signal generator to [VHF ANT] connector and set as: Frequency : 146.0000 MHz Level : 7.1 mV* (-30 dBm) Modulation: OFF • Receiving 	PA	Connect an RF voltmeter to check point P501 via the JIG cable (A).	Maximum level	PA	L521
	2	<ul style="list-style-type: none"> • Receiving 			-14 dBm		R547
After adjustment, connect P501 (PA unit) to J51 on the MAIN unit.							
144 M PEAK (MAIN BAND)	1	<ul style="list-style-type: none"> • Display frequency: 145.9800 MHz • Mode : FM • Connect an SSG to [VHF ANT] connector and set as: Frequency : 145.9800 MHz Level : 3.2 μV* (-97 dBm) Modulation: 1 kHz/\pm5.0 kHz Dev. • Receiving 	Rear panel	Connect an distortion meter to [EXT SP] connector with an 8 Ω load.	Minimum audio distortion level	MAIN	Adjust in sequence L51, L52 several times.
	2	<ul style="list-style-type: none"> • Mode : USB • Set an SSG as : Frequency : 145.9815 MHz Level : 0.1 μV* (-127 dBm) Modulation: OFF • Receiving 		Connect an AC millivolt meter to [EXT SP] connector with an 8 Ω load.	Maximum noise output level		L53, L352, L353, L354
144 M TOTAL GAIN (MAIN BAND)	1	<ul style="list-style-type: none"> • Display frequency: 145.9800 MHz • Mode : USB • Set an SSG as : Frequency : 145.9815 MHz Level : 1 mV* (-47 dBm) Modulation: OFF • Receiving 	Rear panel	Connect an AC millivolt meter to [EXT SP] connector with an 8 Ω load.	1.0 V (0 dB)	Front panel	main [AF] volume
	2	<ul style="list-style-type: none"> • Set an SSG as : Level : OFF • Receiving 			100 mV (20 dB of AF level difference as step 1.)	MAIN	R360
144 M PEAK (SUB BAND)	1	<ul style="list-style-type: none"> • Sub display freq. : 145.9800 MHz • Mode : FM • Connect an SSG to [VHF ANT] connector and set as: Frequency : 145.9800 MHz Level : 3.2 μV* (-97 dBm) Modulation: 1 kHz/\pm5.0 kHz Dev. • Receiving 	Rear panel	Connect an distortion meter to [EXT SP] connector with an 8 Ω load.	Minimum audio distortion level	MAIN	Adjust in sequence L651, L652 several times.
	2	<ul style="list-style-type: none"> • Mode : USB • Set an SSG as : Frequency : 145.9815 MHz Level : 0.1 μV* (-127 dBm) Modulation: OFF • Receiving 		Connect an AC millivolt meter to [EXT SP] connector with an 8 Ω load.	Maximum noise output level		L653, L851, L852, L853
144 M TOTAL GAIN (SUB BAND)	1	<ul style="list-style-type: none"> • Display frequency: 145.9800 MHz • Mode : USB • Set an SSG as : Frequency : 145.9815 MHz Level : 1 mV* (-47 dBm) Modulation: OFF • Receiving 	Rear panel	Connect an AC millivolt meter to [EXT SP] connector with an 8 Ω load.	1.0 V (0 dB)	Front panel	sub [AF] volume
	2	<ul style="list-style-type: none"> • Set an SSG as : Level : OFF • Receiving 			100 mV (20 dB of AF level difference as step 1.)	MAIN	R857

*This output level of a standard signal generator (SSG) is indicated as SSG's open circuit.

• PA UNIT

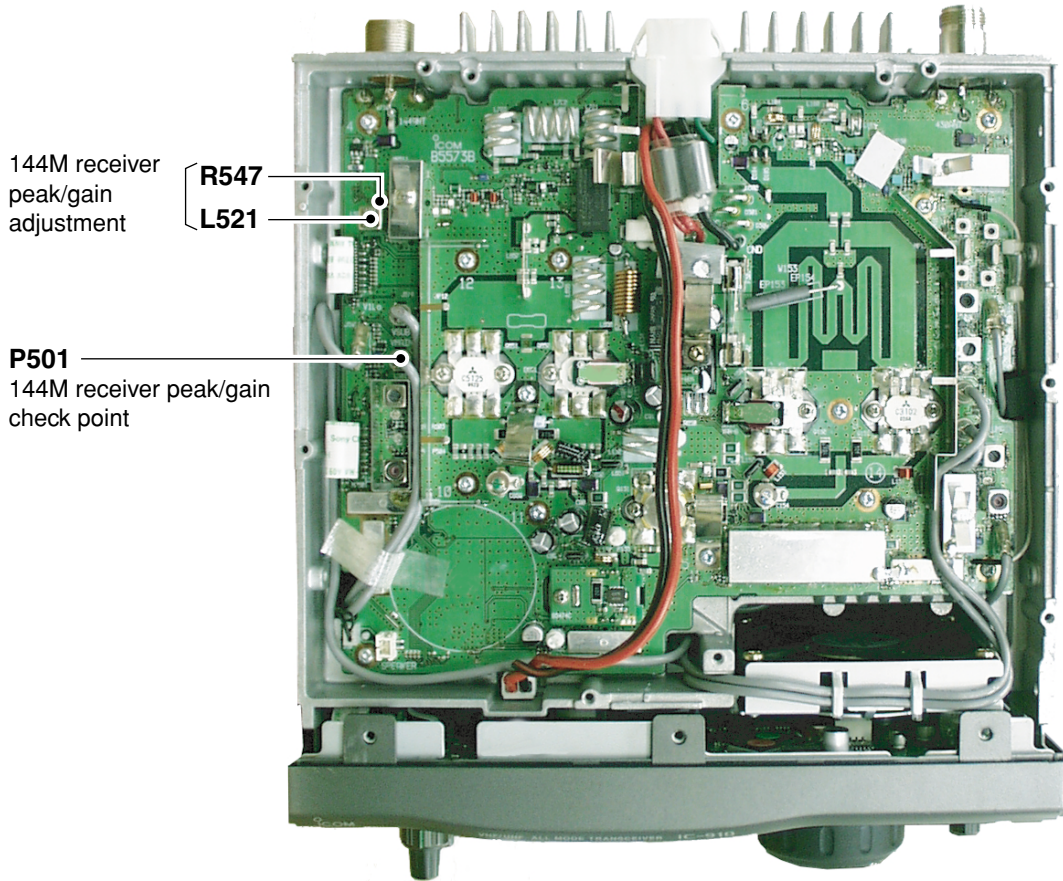

• MAIN UNIT

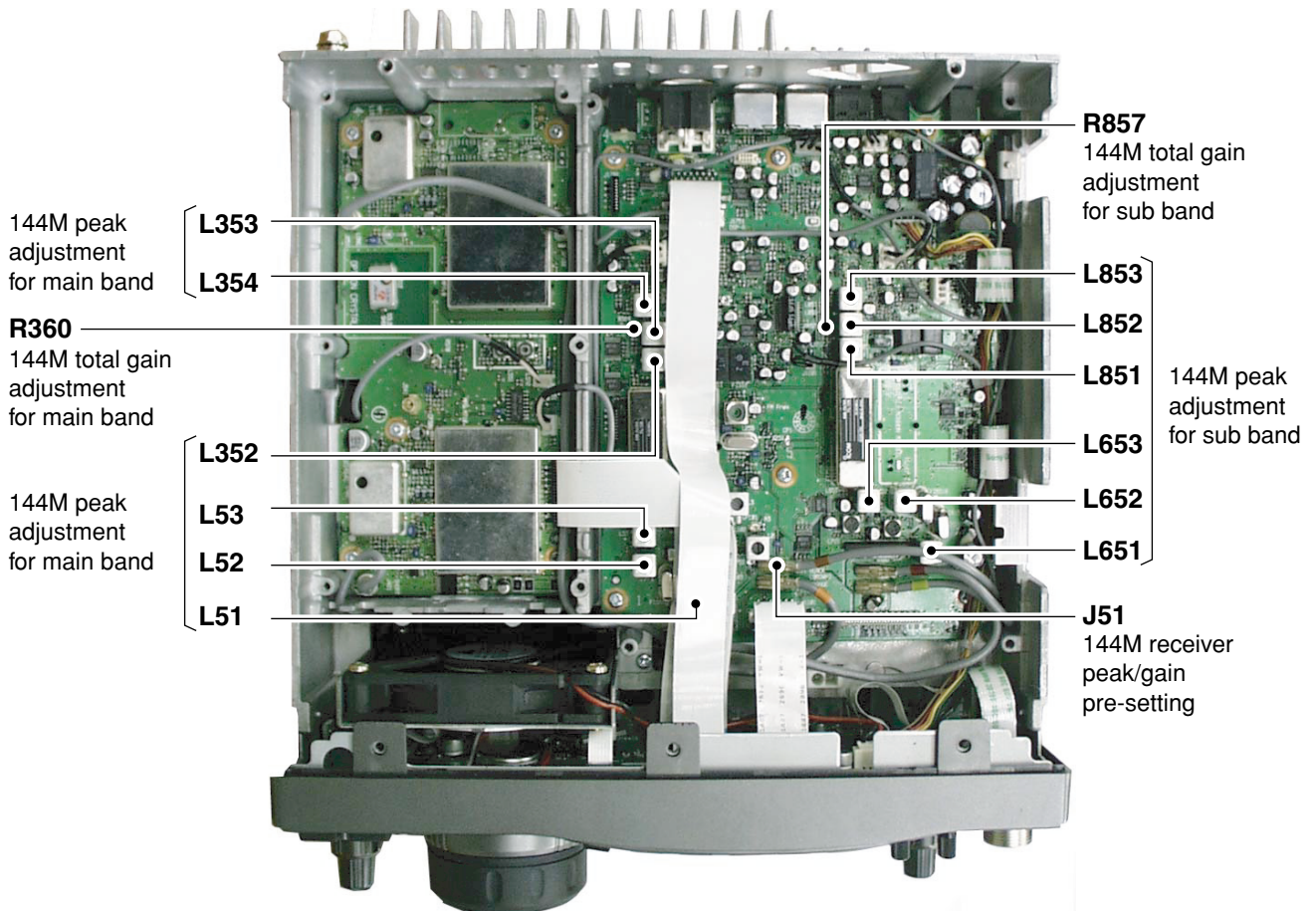

RECEIVER ADJUSTMENTS (continued)

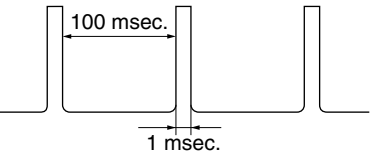
ADJUSTMENT	ADJUSTMENT CONDITION	MEASUREMENT		VALUE	ADJUSTMENT POINT			
		UNIT	LOCATION		UNIT	ADJUST		
430 M PEAK (MAIN BAND)	1 <ul style="list-style-type: none"> • Display frequency: 435.0200 MHz • Mode : FM • Connect a standard signal generator to [UHF ANT] connector and set as: Frequency : 435.0200 MHz Level : 1 μV* (-107 dBm) Modulation: 1 kHz/±5.0 kHz Dev. • Receiving 	MAIN	Connect a digital multimeter or oscilloscope to check point CP851.	Maximum voltage	PA	L22, L23, L282, L283		
430 M PEAK (SUB BAND)	1 <ul style="list-style-type: none"> • Sub display freq. : 435.0200 MHz • Mode : FM • Set an SSG as : Frequency : 435.0200 MHz Level : 1 μV* (-107 dBm) Modulation: 1 kHz/±5.0 kHz Dev. • Receiving 	MAIN	Connect a digital multimeter or oscilloscope to check point CP852.	Maximum voltage	PA	L280, L281		
430 M TOTAL GAIN (MAIN BAND)	1 <ul style="list-style-type: none"> • Display frequency: 435.0200 MHz • Mode : USB • Set an SSG as : Frequency : 435.0215 MHz Level : 1 mV* (-47 dBm) Modulation: OFF • Receiving 	Rear panel	Connect an AC millivolt meter to [EXT SP] connector with an 8 Ω load.	1.0 V (0 dB)	Front panel	main [AF] volume		
	2 <ul style="list-style-type: none"> • Set an SSG as : Level : OFF • Receiving 			100 mV (20 dB of AF level difference as step 1.)	PA	R61		
NOISE BLANKER (MAIN BAND)	1 <ul style="list-style-type: none"> • Display frequency: 145.9800 MHz • Mode : USB • [NB] : OFF • Connect an SSG to [VHF ANT] connector and set as : Frequency : 145.98150 MHz Level : 5.6 μV* (-92 dBm) Modulation: OFF and apply following signal to [VHF ANT] connector.  <ul style="list-style-type: none"> • Receiving 	MAIN	Connect an oscilloscope to check point CP101.	Maximum noise waveform	MAIN	L102, L103		
	2 <ul style="list-style-type: none"> • [NB] : ON • Set an SSG as : Level : 3.2 μV* (-97 dBm) • Receiving 			The noise must be blanked.		Verify		
	(SUB BAND)			3 <ul style="list-style-type: none"> • Sub display freq. : 145.9800 MHz • Mode : USB • [NB] : OFF • Set an SSG as : Level : 5.6 μV* (-92 dBm) • Receiving 		Connect an oscilloscope to check point CP701.	Maximum noise waveform	L703, L704
	4 <ul style="list-style-type: none"> • [NB] : ON • Set an SSG as : Level : 3.2 μV* (-97 dBm) • Receiving 			The noise must be blanked.		Verify		

*This output level of a standard signal generator (SSG) is indicated as SSG's open circuit.

• PA UNIT

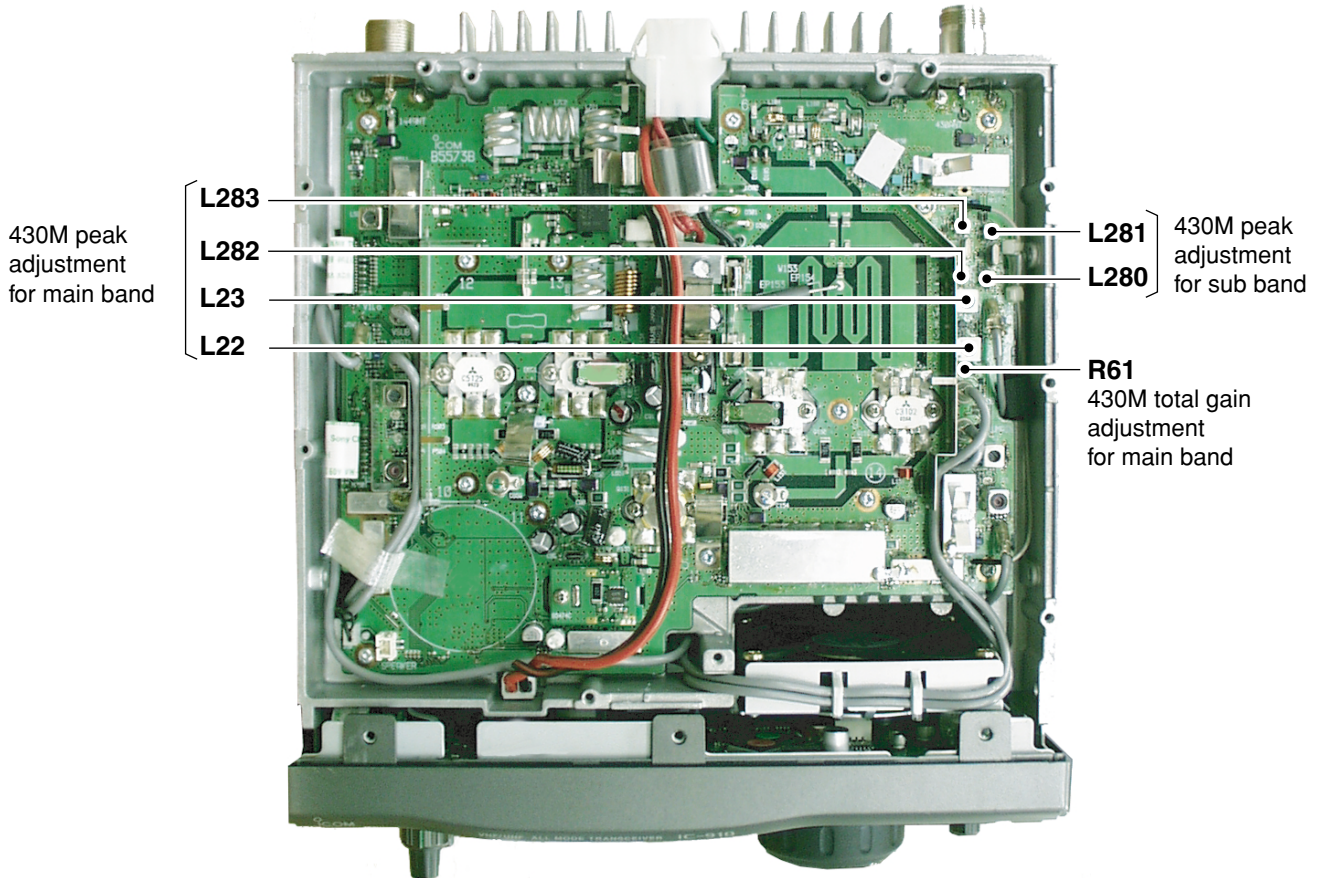

• MAIN UNIT

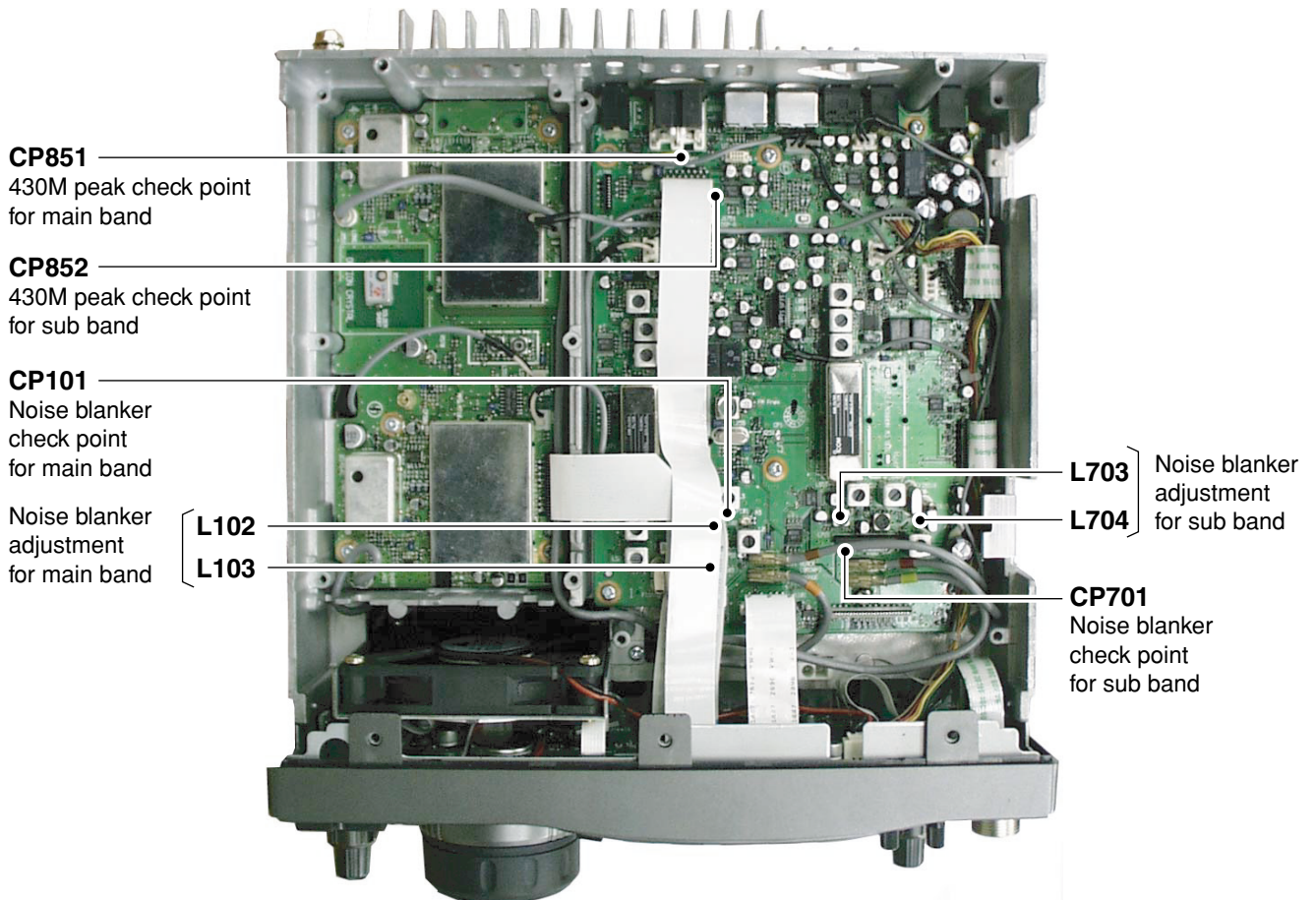

5-5 TRANSMITTER ADJUSTMENTS

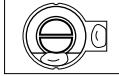
ADJUSTMENT	ADJUSTMENT CONDITION	MEASUREMENT		VALUE	ADJUSTMENT POINT			
		UNIT	LOCATION		UNIT	ADJUST		
PA UNIT PRESETTING	1	<ul style="list-style-type: none"> • Preset R131, R135, R150, R650 (PA unit) to max. counter clockwise. • Preset R3, R138, R503 (PA unit) to center position. • Preset C154, C659 (PA unit) to center position as illustration at right. 						
IDLING CURRENT (for 144 M)	1	<ul style="list-style-type: none"> • Display frequency: [EUR], [KOR] 145.0000 MHz [USA-1], [AUS] 146.0000 MHz • Mode : CW • Transmitting 	PA	Connect an ammeter (3 A) between power supply and the IC-910H.	At the point where the TX current increases 0.5 A.	PA	R131	
	2	<ul style="list-style-type: none"> • Transmitting 			At the point where the TX current increases 1.0 A as step 1.		R135 (R138)	
	3	<ul style="list-style-type: none"> • Transmitting 			At the point where the TX current increases 0.5 A as step 2.		R650	
	(for 430 M)	4	<ul style="list-style-type: none"> • Display frequency: [EUR], [KOR] 435.0000 MHz [USA-1], [AUS] 450.0000 MHz • Mode : CW • Transmitting 			At the point where the TX current increases 1.0 A.		R150
RF PEAK (for 430 M)	1	<ul style="list-style-type: none"> • Display frequency: 440.0000 MHz • Connect an SSG to P1 on the PA unit via the JIG cable (A) and set as: Frequency : 10.850 MHz Level : 18 mV* (-22 dBm) Modulation: OFF • Transmitting 	Rear panel	Connect an RF power meter to [UHF ANT] connector.	Maximum output power	PA	L1, L2	
	2	<ul style="list-style-type: none"> • Set an SSG as: Level : 0.79 μV* (-2 dBm) • Transmitting 						C154
	(for 144 M)	3	<ul style="list-style-type: none"> • Connect an SSG to P501 on the PA unit via the JIG cable (A) and set as: Frequency : 10.850 MHz Level : 18 mV* (-22 dBm) Modulation: OFF 		Connect an RF power meter to [VHF ANT] connector.	Refer page 5-16 software adjustment 6.		
		4	<ul style="list-style-type: none"> • Display frequency: 146.0000 MHz • Set an SSG as: Level : 0.79 μV* (-2 dBm) • Transmitting 			Maximum output power	PA	C659
IF PEAK	1	<ul style="list-style-type: none"> • Display frequency: Any • Mode : USB • MIC gain : Center • Connect an audio generator to [MIC] connector and set as: Frequency : 1.5 kHz Level : 2 mVrms • Transmitting 	MAIN	Connect an RF voltmeter to check point J51 via the JIG cable (B).	Maximum level	MAIN	L2, L3	
CARRIER SUPPRESSION	1	<ul style="list-style-type: none"> • Display frequency: Any • Mode : USB • Mic gain : Minimum • Apply no audio signals to [MIC] connector. • Transmitting 	MAIN	Connect a spectrum analyzer to check point J51 via the JIG cable (B).	Minimum carrier level	MAIN	R206, R215	
	2	<ul style="list-style-type: none"> • Mode : LSB • Transmitting 						
	3	• Repeat step 1, step 2 several times.						

• PA UNIT

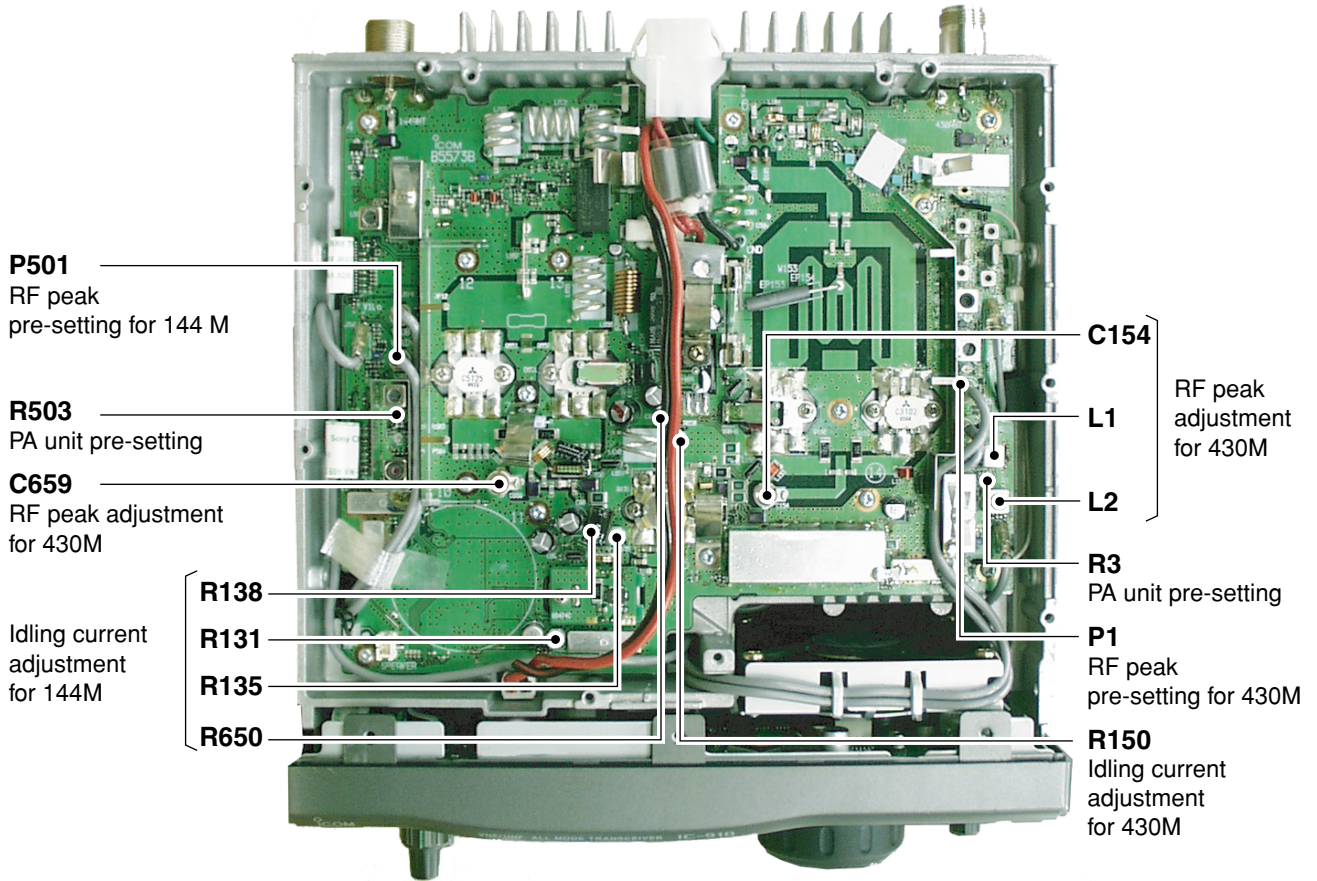

• MAIN UNIT

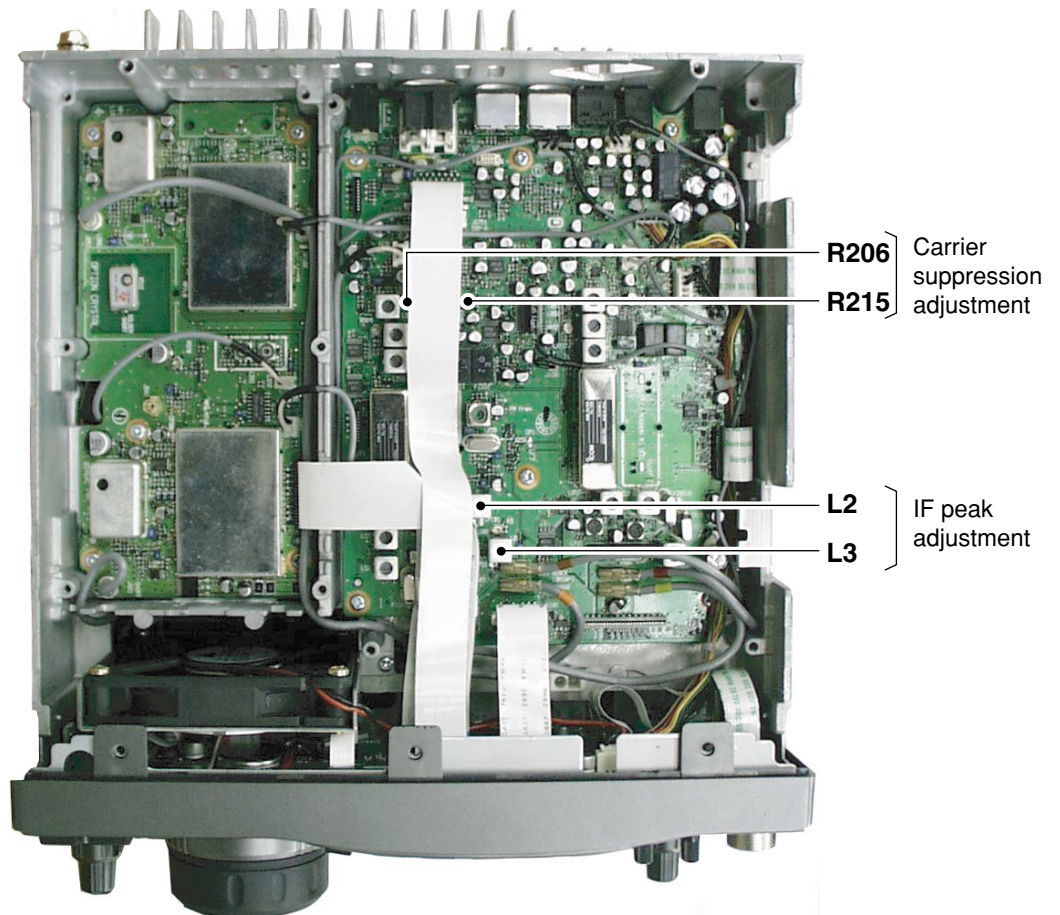

TRANSMITTER ADJUSTMENTS (continued)

ADJUSTMENT	ADJUSTMENT CONDITION	MEASUREMENT		VALUE	ADJUSTMENT POINT	
		UNIT	LOCATION		UNIT	ADJUST
IF TOTAL GAIN	1 <ul style="list-style-type: none"> • Display frequency: Any • Mode : USB • MIC gain : Center • Disconnect P501 (PA unit) from J51 on the MAIN unit. • Connect an audio generator to [MIC] connector and set as: <ul style="list-style-type: none"> Frequency : 1.5 kHz Level : 2 mVrms • Transmitting 	MAIN	Connect an RF voltmeter to check point J51 via the JIG cable (B).	-22 dBm	MAIN	R3
After adjustment, connect P501 (PA unit) to J51 on the MAIN.						
TOTAL GAIN (for 144 M)	1 <ul style="list-style-type: none"> • Display frequency: <ul style="list-style-type: none"> [EUR], [KOR] 145.0000 MHz [USA-1], [AUS] 146.0000 MHz • Mode : USB • RF power : Maximum • MIC gain : Center • Connect an audio generator to [MIC] connector and set as: <ul style="list-style-type: none"> Frequency : 1.5 kHz Level : 2 mVrms • Transmitting 	Rear panel	Connect an RF power meter to [VHF ANT] connector.	50 W	PA	R503
(for 430 M)	2 <ul style="list-style-type: none"> • Display frequency: <ul style="list-style-type: none"> [EUR], [KOR] 435.0000 MHz [USA-1], [AUS] 450.0000 MHz • Transmitting 		Connect an RF power meter to [UHF ANT] connector.	37.5 W		R3
Ic APC	3 <ul style="list-style-type: none"> • Display frequency: 146.0000 MHz • Mode : USB • Connect CP1631 (MAIN unit) to GND. • RF power : Maximum • Mic gain : Center • Connect an audio generator to [MIC] connector and set as: <ul style="list-style-type: none"> Frequency : 1.5 kHz Level : 20 mVrms • Transmitting 	Rear panel	Connect an ammeter (30A) between power supply and the IC-910H.	23 A	MAIN	R1613
After adjustment, disconnect CP1631 (PA unit) from GND on the MAIN.						
DRIVE LEVEL	1 <ul style="list-style-type: none"> • Display frequency: 146.0000 MHz • Mode : USB • RF power : Maximum • Mic gain : Center • Disconnect P501 (PA unit) from J51 on the MAIN unit. • Connect an audio generator to [MIC] connector and set as: <ul style="list-style-type: none"> Frequency : 1.5 kHz Level : 20 mVrms • Transmitting 	MAIN	Connect an RF voltmeter to check point J51 via the JIG cable (B).	Read the RF voltmeter indication.		Verify
	2 <ul style="list-style-type: none"> • Mode : CW • CW paddle : OFF • Connect a keyer to the [KEY] jack. • Key down (transmitting) 			Same level as step 1	MAIN	R202
After adjustment, connect P501 (PA unit) to J51 on the MAIN.						
LO LEAK (for 144 M)	1 LO leak must be performed after software adjustment (7) "TX POWER/METER".					
	<ul style="list-style-type: none"> • Display frequency: <ul style="list-style-type: none"> [EUR], [KOR] 146.0000 MHz [USA-1], [AUS] 148.0000 MHz • Mode : USB • RF power : Minimum • MIC gain : Center • Transmitting 	Rear panel	Connect an RF power meter to [VHF ANT] connector.	Minimum output power	PA	R504

• MAIN UNIT

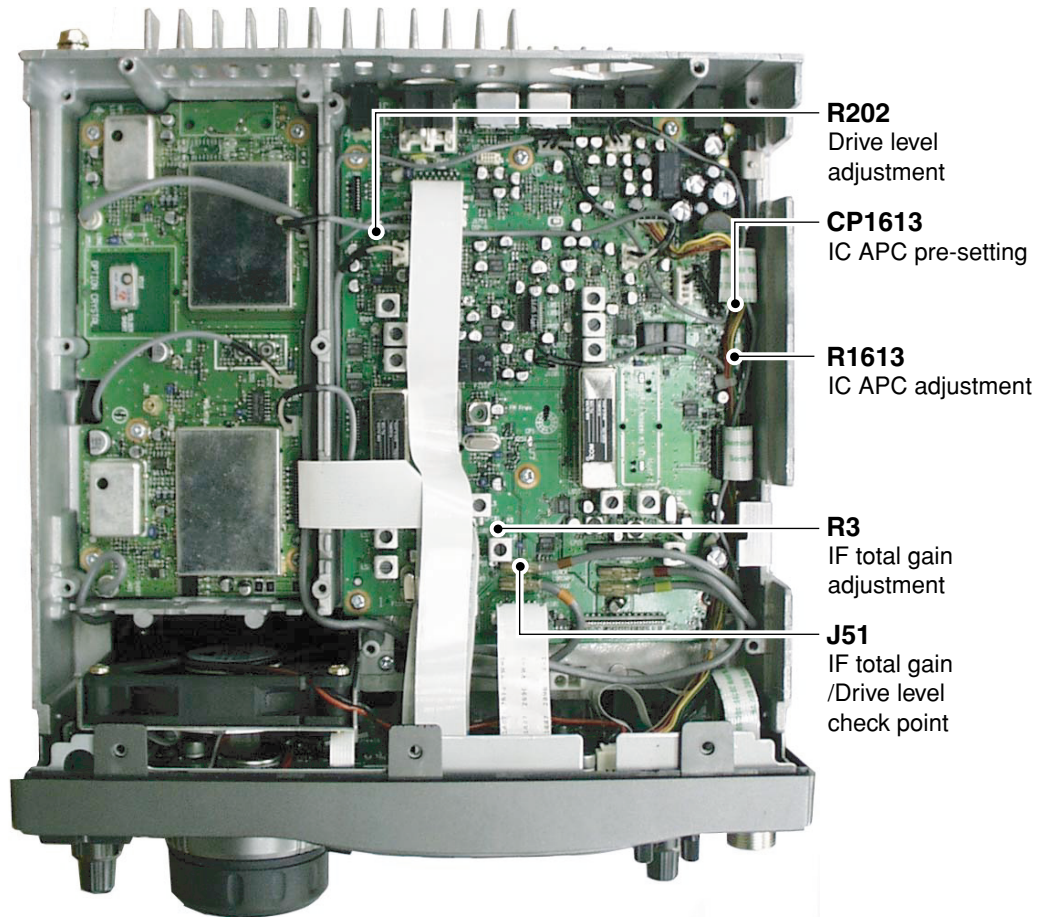

• PA UNIT

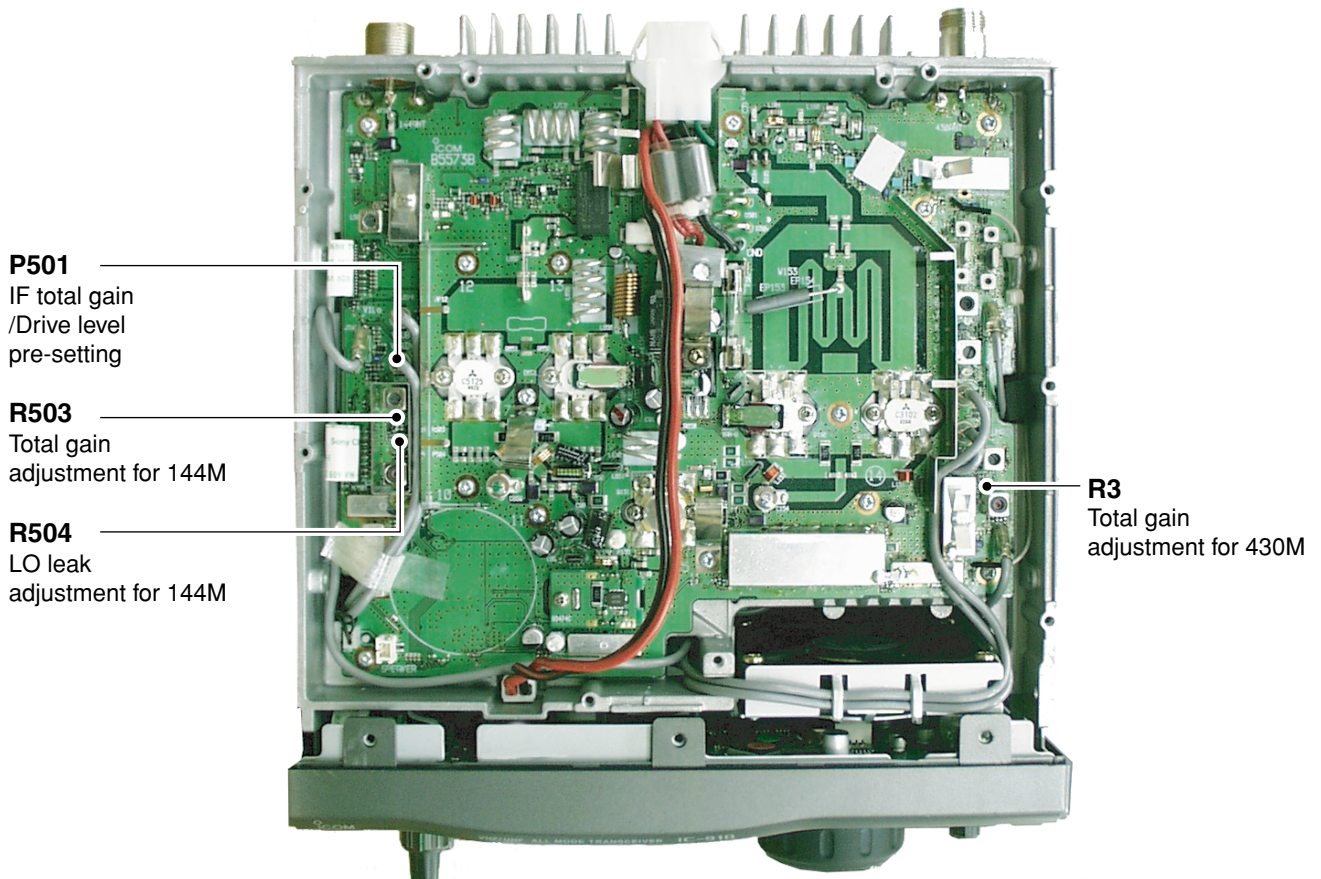

5-6 SOFTWARE ADJUSTMENT

ADJUSTMENT	ADJUSTMENT CONDITION	DISPLAY	OPERATION
ENTERING SOFTWARE ADJUSTMENT	1 <ul style="list-style-type: none"> • Enter software adjustment mode: <ol style="list-style-type: none"> ① Turn power OFF. ② Terminate the [REMOTE] jack with a 3.5(d) mm mini-plug. ③ While pushing [RIT] and [SATELLITE] keys, turn power ON. 	<i>Adjust</i> <i>0-9</i>	The display shows the selection item screen for the adjustment mode, push [0]–[9] key to select adjustment item. Once entering adjustment mode, use [UP]/[DOWN] key to skip/back items, or [ENT] to return the selection item screen .
	CAUTION: NEVER select adjustment items [6]–[9] key on the selection item screen while transceiver is connected to an SSG. Because transceiver automatically transmits when transmit items [6]–[9] is selected.		
ADJUSTMENT ITEM (0) VOLUME CENTER	1 <ul style="list-style-type: none"> • Push [0] to enter the volume center setting. • Set the [RIT] and [SHIFT] controls to center. 	<i>Set -Cent</i> <i>rit -5Ft</i>	Push [RIT] key to set the volume center positions, and to step next.
PLL UNLOCK	1 <ul style="list-style-type: none"> • Wait for a while. 	^{USB} <i>146.020.0</i> <i>144 PLL</i>	Verify the unlock detection for VHF by blinking the frequency on the display, then push [RIT] key to step next.
	2	^{USB} <i>440.020.0</i> <i>430 PLL</i>	Verify the unlock detection for UHF by blinking the frequency on the display, then push [RIT] key to exit volume center setting to selection item screen .
ADJUSTMENT ITEM (1) TUNED BPF (for 144 M)	1 <ul style="list-style-type: none"> • Push [1] to enter the receiver adjustment. • Connect a standard signal generator to [VHF ANT] connector and set as: <ul style="list-style-type: none"> Frequency : 136.02150 MHz Level : 50 μV* (–73 dBm) Modulation : OFF • Receiving 	^{USB} <i>136.020.0</i> <i>144tun.1</i>	Push [RIT] key to tune the “144 tune 1”, and to step next.
	2 <ul style="list-style-type: none"> • Set an SSG as : <ul style="list-style-type: none"> Frequency : 146.02150 MHz Level : 50 μV* (–73 dBm) • Receiving 	^{USB} <i>146.020.0</i> <i>144tun.2</i>	Push [RIT] key to tune the “144 tune 2”, and to step next.
	3 <ul style="list-style-type: none"> • Set an SSG as : <ul style="list-style-type: none"> Frequency : 146.02150 MHz Level : 50 μV* (–73 dBm) • Receiving 	^{USB} <i>173.980.0</i> <i>144tun.3</i>	Push [RIT] key to tune the “144 tune 3”, and to step next.
(for 430 M)	4 <ul style="list-style-type: none"> • Set an SSG as : <ul style="list-style-type: none"> Frequency : 420.02150 MHz Level : 50 μV* (–73 dBm) • Receiving 	^{USB} <i>420.020.0</i> <i>430tun.1</i>	Push [RIT] key to tune the “430 tune 1”, and to step next.
	5 <ul style="list-style-type: none"> • Connect an SSG to [UHF ANT] connector and set as : <ul style="list-style-type: none"> Frequency : 440.02150 MHz Level : 50 μV (–73 dBm) • Receiving 	^{USB} <i>440.020.0</i> <i>430tun.2</i>	Push [RIT] key to tune the “430 tune 2”, and to step next.
	6 <ul style="list-style-type: none"> • Set an SSG as : <ul style="list-style-type: none"> Frequency : 479.98150 MHz Level : 50 μV* (–73 dBm) • Receiving 	^{USB} <i>479.980.0</i> <i>430tun.3</i>	Push [RIT] key to tune the “430 tune 3”. Turn power OFF and ON to return the normal operation mode. Then start the receiver adjustments (page 5-3).

*This output level of a standard signal generator (SSG) is indicated as SSG's open circuit.

SOFTWARE ADJUSTMENT (continued)

ADJUSTMENT	ADJUSTMENT CONDITION	DISPLAY	OPERATION	
ADJUSTMENT ITEM (2) S-METER (MAIN BAND)	1	<ul style="list-style-type: none"> • Enter software adjustment mode (Refer page 5-12). • Push [2] key to enter the S-meter adjustment • Connect an SSG to [VHF ANT] connector and set as : <ul style="list-style-type: none"> Frequency : 146.0200 MHz Level : OFF • Receiving 	USB 146.0 18.5 51 0 0	Push [RIT] key to store the “S0” level into memory, and to step next.
	2	<ul style="list-style-type: none"> • Set an SSG as : <ul style="list-style-type: none"> Frequency : 146.0200 MHz Level : 3.2 μV* (-97 dBm) • Receiving 	USB 146.0 18.5 51 0 9	Push [RIT] key to store the “S9” level into memor, and to step next.
	3	<ul style="list-style-type: none"> • Set an SSG as : <ul style="list-style-type: none"> Frequency : 146.0200 MHz Level : 1 mV* (-47 dBm) • Receiving 	USB 146.0 18.5 51 0 60	Push [RIT] key to store the “S9+60” level into memory, and to step next.
	4	<ul style="list-style-type: none"> • Set an SSG as : <ul style="list-style-type: none"> Frequency : 146.0200 MHz Level : OFF • Receiving 	FM 146.020.0 51 0 0	Push [RIT] key to store the “S0” level into memory, and to step next.
	5	<ul style="list-style-type: none"> • Set an SSG as : <ul style="list-style-type: none"> Frequency : 146.0200 MHz Level : 3.2 μV* (-97 dBm) Modulation : OFF • Receiving 	FM 146.020.0 51 0 9	Push [RIT] key to store the “S9” level into memory, and to step next.
	6	<ul style="list-style-type: none"> • Set an SSG as : <ul style="list-style-type: none"> Frequency : 146.0200 MHz Level : 32 μV* (-77 dBm) • Receiving 	FM 146.020.0 51 0 60	Push [RIT] key to store the “S9+60” level into memory, and to step next.
(SUB BAND)	7	<ul style="list-style-type: none"> • Set an SSG as : <ul style="list-style-type: none"> Frequency : 146.0200 MHz Level : OFF • Receiving 	51 0 0 SUB USB 146.0 18.5	Push [RIT] key to store the “S0” level into memory, and to step next.
	8	<ul style="list-style-type: none"> • Set an SSG as : <ul style="list-style-type: none"> Frequency : 146.0200 MHz Level : 3.2 μV* (-97 dBm) • Receiving 	51 0 9 SUB USB 146.0 18.5	Push [RIT] key to store the “S9” level into memory, and to step next.
	9	<ul style="list-style-type: none"> • Set an SSG as : <ul style="list-style-type: none"> Frequency : 146.0200 MHz Level : 1 mV* (-47 dBm) • Receiving 	51 0 60 SUB USB 146.0 18.5	Push [RIT] key to store the “S9+60” level into memory, and to step next.

*This output level of a standard signal generator (SSG) is indicated as SSG's open circuit.

SOFTWARE ADJUSTMENT (continued)

ADJUSTMENT	ADJUSTMENT CONDITION	DISPLAY	OPERATION
S-METER (SUB BAND)	10 • Set an SSG as : Frequency : 146.0200 MHz Level : OFF • Receiving		Push [RIT] key to store the “S0” level into memory, and to step next.
	11 • Set an SSG as : Frequency : 146.0200 MHz Level : 3.2 μV* (–97 dBm) Modulation : OFF • Receiving		Push [RIT] key to store the “S9” level into memory, and to step next.
	12 • Set an SSG as : Frequency : 146.0200 MHz Level : 32 μV* (–77 dBm) • Receiving		Push [RIT] key to store the “S9+60” level into memory. Then the display change to the noise SQL adjustment.
ADJUSTMENT ITEM (3) NOISE SQL (MAIN BAND)	1 • Connect an SSG to [VHF ANT] connector and set as : Frequency : 146.0200 MHz Level : 0.063 μV* (–131 dBm) Modulation : OFF • Receiving		Push [RIT] key to store the noise squelch thresh-hold level for FM mode into memory, and to step next.
	2 • Set an SSG as : Frequency : 146.0200 MHz Level : 0.2 μV* (–121 dBm) • Receiving		Push [RIT] key to store the noise squelch tight level for FM mode into memory, and to step next.
	3 • Set an SSG as : Frequency : 146.0200 MHz Level : 0.063 μV* (–131 dBm) • Receiving		Push [RIT] key to store the noise squelch thresh-hold level for FM narrow mode into memory, and to step next.
	4 • Set an SSG as : Frequency : 146.0200 MHz Level : 0.2 μV* (–121 dBm) • Receiving		Push [RIT] key to store the noise squelch tight level for FM narrow mode into memory, and to step next.
(SUB BAND)	5 • Set an SSG as : Frequency : 146.0200 MHz Level : 0.063 μV* (–131 dBm) • Receiving		Push [RIT] key to store the noise squelch thresh level for FM mode into memory, and to step next.
	6 • Set an SSG as : Frequency : 146.0200 MHz Level : 0.2 μV* (–121 dBm) • Receiving		Push [RIT] key to store the noise squelch tight level for FM mode into memory, and to step next.
	7 • Set an SSG as : Frequency : 146.0200 MHz Level : 0.063 μV* (–131 dBm) • Receiving		Push [RIT] key to store the noise squelch threshold level for FM narrow mode into memory, and to step next.
	8 • Set an SSG as : Frequency : 146.0200 MHz Level : 0.2 μV* (–121 dBm) • Receiving		Push [RIT] key to store the noise squelch tight level for FM narrow mode into memory. Then the display change to the AFC center adjustment.

*This output level of a standard signal generator (SSG) is indicated as SSG's open circuit.

SOFTWARE ADJUSTMENT (continued)

ADJUSTMENT	ADJUSTMENT CONDITION	DISPLAY	OPERATION
ADJUSTMENT ITEM (4) CENTER (MAIN BAND)	<ul style="list-style-type: none"> • Connect an SSG to [VHF ANT] connector and set as : <ul style="list-style-type: none"> Frequency : 146.0200 MHz Level : 5.6 μV* (-92 dBm) Modulation : OFF • Receiving 	^{FM} 146.020.0 Center	Push [RIT] key to store the AFC center for FM mode into memory, and to step next.
		^{FMN} 146.020.0 Center	Push [RIT] key to store the AFC center for FM narrow mode into memory, and to step next.
		Center ^{SUB} ^{FM} 146.020.0	Push [RIT] key to store the AFC center for FM mode into memory, and to step next.
		Center ^{SUB} ^{FMN} 146.020.0	Push [RIT] key to store the AFC center for FM narrow mode into memory. Then the display change to the filter calibration adjustment.
ADJUSTMENT ITEM (5) FILTER CALIBRATION (MAIN BAND)	<ul style="list-style-type: none"> • Connect an SSG to [VHF ANT] connector and set as : <ul style="list-style-type: none"> Frequency : 146.0200 MHz Level : 5.6 μV* (-92 dBm) Modulation : OFF • Receiving 	^{USB} 146.0 18.5 FIL-CAL	Push [RIT] key to make the calibration, and to step next.
		(SUB BAND) 2	FIL-CAL ^{SUB} ^{USB} 146.0 18.5

*This output level of a standard signal generator (SSG) is indicated as SSG's open circuit.

SOFTWARE ADJUSTMENT (continued)

ADJUSTMENT	ADJUSTMENT CONDITION	DISPLAY	OPERATION	
ADJUSTMENT ITEM (6) RF PEAK	1	<ul style="list-style-type: none"> • Enter software adjustment mode (Refer page 5-12). • Push [6] key to enter the RF peak adjustment for TX. • Connect an RF power meter to [VHF ANT] connector. 	USB 145.0 10.0 144tun-	Push [RIT] key to start transmitting.
	2	<ul style="list-style-type: none"> • Connect an SSG to P501 on the PA unit via the JIG cable (A) and set as: Frequency : 10.850 MHz Level : 18 mV* (-22 dBm) Modulation: OFF <p>NOTE: While transmitting, adjust SSG's level and keep the output power less than 30 W.</p>	USB 145.0 10.0 144tun 1	<ul style="list-style-type: none"> • Pushing [SET] key, tune the [MAIN DIAL] to maximum. • Adjust L501, L502 on the PA unit (illustration for location page 5-9) to maximum. • Pushing [SET] key, tune the [MAIN DIAL] to maximum, then push [RIT] key to store peak setting into memory and to step next.
	3		USB 140.0 10.0 144tun2	(1) Pushing [ATT] key, tune the [MAIN DIAL] to maximum. (2) Pushing [SET] key, tune the [MAIN DIAL] to maximum. (3) Repeat (1) and (2) several times until output power will be peak, then push [RIT] key to store peak setting into memory and to step next.
	4		USB 150.0 10.0 144tun3	Same as step 3. Then turn power OFF and ON to return the normal operation mode. Then continue to adjust from step 4 of the RF PEAK adjustment (page 5-8).
ADJUSTMENT ITEM (7) TX POWER/ METER (for 144 M)	1	<ul style="list-style-type: none"> • Enter software adjustment mode (Refer page 5-12). • Push [7] key to enter the TX power/meter adjustment. • Connect an RF power meter to [VHF ANT] connector. 	CW 145.0 10.0 14Po --	Push [RIT] key to start transmitting.
	2		CW 145.0 10.0 14Po H	Tune the [MAIN DIAL] to 100 W (High power). Push [RIT] key to store the adjustment value into memory, and to step next.
	3		CW 145.0 10.0 14Po L	Tune the [MAIN DIAL] to 50 W (Middle power). Push [RIT] key to store the adjustment value into memory, and to step next.
	4		CW 145.0 10.0 14Po 0	Verify the output power (Low power) is 1-5 W, then push [RIT] key to step next.
(for 1200 M)	5	<ul style="list-style-type: none"> • Connect a digital multimeter or oscilloscope to check point CP1631. 	CW 145.0 10.0 12Po --	Push [RIT] key to start transmitting.
	6		CW 145.0 10.0 12Po H	Tune the [MAIN DIAL] to 3.0 V at the check point CP1681. Push [RIT] key to store the adjustment value into memory, and to step next.

*This output level of a standard signal generator (SSG) is indicated as SSG's open circuit.

SOFTWARE ADJUSTMENT (continued)

ADJUSTMENT	ADJUSTMENT CONDITION	DISPLAY	OPERATION
TX POWER/ METER (for 430 M)	7	<ul style="list-style-type: none"> • Connect an RF power meter to [UHF ANT] connector. 	Push [RIT] key to start transmitting.
	8		Tune the [MAIN DIAL] to 75 W (High power). Push [RIT] key to store the adjustment value into memory, and to step next.
	9		Tune the [MAIN DIAL] to 37.5 W (Middle power). Push [RIT] key to store the adjustment value into memory, and to step next.
	10		Verify the output power (Low) is 1–5 W, then push [RIT] key to step next.
ADJUSTMENT ITEM (8) DEVIATION	1	<ul style="list-style-type: none"> • Enter software adjustment mode (Refer page 5-12). • Push [8] key to enter the deviation adjustment. • MIC gain : Center 	Push [RIT] key to start transmitting.
	2	<ul style="list-style-type: none"> • Connect an FM deviation meter to [VHF ANT] connector through an attenuator and set as: HPF : OFF LPF : 20 kHz De-emphasis : OFF Detector : (P–P)/2 	Tune the [MAIN DIAL] to ±4.5 kHz FM deviation. Push [RIT] key to store the adjustment value into memory, and to step next.
	3	<ul style="list-style-type: none"> • Connect an audio generator to [MIC] connector and set as: Frequency : 1.0 kHz Level : 20 mVrms 	Tune the [MAIN DIAL] to ±2.25 kHz FM deviation. Push [RIT] key to store the adjustment value into memory, and to step next.
	4	<ul style="list-style-type: none"> • Apply no audio signals to [MIC] connector. 	Tune the [MAIN DIAL] to ±0.6 kHz CTCSS tone deviation. Push [RIT] key to store the adjustment value into memory, and to step next.
	5		Tune the [MAIN DIAL] to ±0.6 kHz europe tone deviation. Push [RIT] key to store the adjustment value into memory. Then turn power OFF and ON to return the normal operation mode.

5-7 UX-910 ADJUSTMENTS

ADJUSTMENT	ADJUSTMENT CONDITION	MEASUREMENT		VALUE	ADJUSTMENT POINT	
		UNIT	LOCATION		UNIT	ADJUST
2ND LO LOCK VOLTAGE	1 <ul style="list-style-type: none"> • Connect an optional UX-910 (1200 MHz band unit). • Display frequency: 1270.5000 MHz • Receiving 	MAIN (UX-910)	Connect a digital multimeter or oscilloscope to check point CP701.	2.6–3.8 V		Verify
1ST LO LOCK VOLTAGE	1 <ul style="list-style-type: none"> • Display frequency: 1240.0000 MHz • Receiving 	MAIN (UX-910)	Connect a digital multimeter or oscilloscope to check point CP501.	6.0–7.0 V		Verify
	2 <ul style="list-style-type: none"> • Display frequency: 1300.0000 MHz • Receiving 			3.4–4.4 V		
RECEIVER GAIN	1 <ul style="list-style-type: none"> • Display frequency: 1280.0000 MHz • Connect a standard signal generator to [12 ANT] connector and set as: Frequency : 1280.0000 MHz Level : 710 μV* (–50 dBm) Modulation: OFF • Receiving 	MAIN (UX-910)	Connect a spectrum analyzer to check point CP311.	–34 dBm (16 dB gain)	MAIN (UX-910)	R224
ATT GAIN	1 <ul style="list-style-type: none"> • Display frequency: 1280.0000 MHz • [ATT] : ON • Set an SSG as : Frequency : 1280.0000 MHz Level : 710 μV* (–50 dBm) Modulation: OFF • Receiving 	MAIN (UX-910)	Connect a spectrum analyzer to check point CP311.	–14 dBm (20 dB of gain difference between the attenuator ON and OFF.)	MAIN (UX-910)	R288
IDLING	1 <ul style="list-style-type: none"> • Display frequency: Any • Mode : CW • Preset R61, R67, R83 to max. clockwise, R13 to max. counter clockwise, and C332 to center. • Connect an RF power meter to [12 ANT]. • Connect an SSG to the check point CP311 and set as : Frequency : 10.8500 MHz Level : OFF • Transmitting 	MAIN (UX-910)	Connect a digital multimeter between check points CP321 and CP322.	0.5 V voltage difference	MAIN (UX-910)	R13
POWER BALLANCE	1 <ul style="list-style-type: none"> • Display frequency: Any • Mode : CW • Connect an SSG to the check point CP311 and set as : Frequency : 10.8500 MHz • Transmitting 	Rear panel	Connect an RF power meter to [12 ANT].	5 W		Adjust SSG's level
	2 <ul style="list-style-type: none"> • Display frequency: 1240.0000 MHz • Transmitting 			Read the RF power meter indication.		Verify
	3 <ul style="list-style-type: none"> • Display frequency: 1300.0000 MHz • Transmitting 			Same power as step 2	MAIN (UX-910)	C332
	4			Repeat step 2 and step 3 several times until power difference is minimum.		
TRANSMITTER GAIN	1 <ul style="list-style-type: none"> • Display frequency: 1270.0000 MHz • Set an SSG as : Frequency : 10.8500 MHz Level : 18 mV* (–22 dBm) • Transmitting 	Rear panel	Connect an RF power meter to [12 ANT].	5 W	MAIN (UX-910)	R83

*This output level of a standard signal generator (SSG) is indicated as SSG's open circuit.

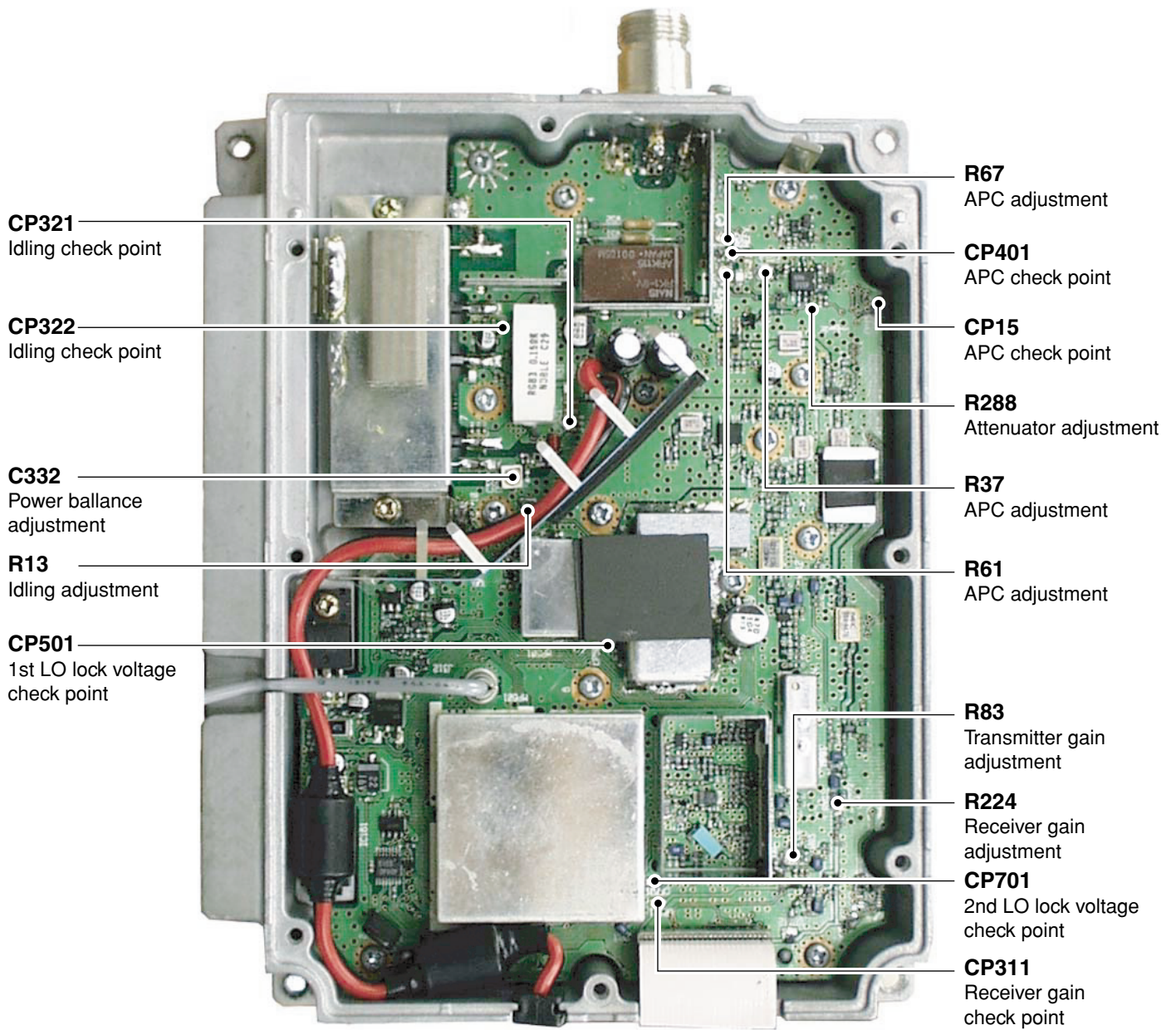

UX-910 ADJUSTMENTS (continued)

ADJUSTMENT	ADJUSTMENT CONDITION	MEASUREMENT		VALUE	ADJUSTMENT POINT		
		UNIT	LOCATION		UNIT	ADJUST	
APC	1	<ul style="list-style-type: none"> • Display frequency: 1270.0000 MHz • Mode : CW • Connect an SSG to the check point CP311 and set as : Frequency : 10.8500 MHz • Transmitting 	Rear panel	Connect an RF power meter to [12 ANT].	13 W		Adjust SSG's level
	2	<ul style="list-style-type: none"> • Transmitting 	MAIN (UX-910)	Connect a digital multimeter or oscilloscope to check point CP15.	3.0 V	MAIN (UX-910)	R37
	3	<ul style="list-style-type: none"> • Transmitting 	Rear panel	Connect an RF power meter to [12 ANT].	10.5 W		Adjust SSG's level
	4	<ul style="list-style-type: none"> • Transmitting 	MAIN (UX-910)	Connect a digital multimeter or oscilloscope to check point CP401.	3.1 V	MAIN (UX-910)	R67
(POWER SET)	5	<ul style="list-style-type: none"> • Transmitting 		Connect a digital multimeter or oscilloscope to check point CP15.	3.0 V	MAIN (UX-910)	R61

*This output level of a standard signal generator (SSG) is indicated as SSG's open circuit.

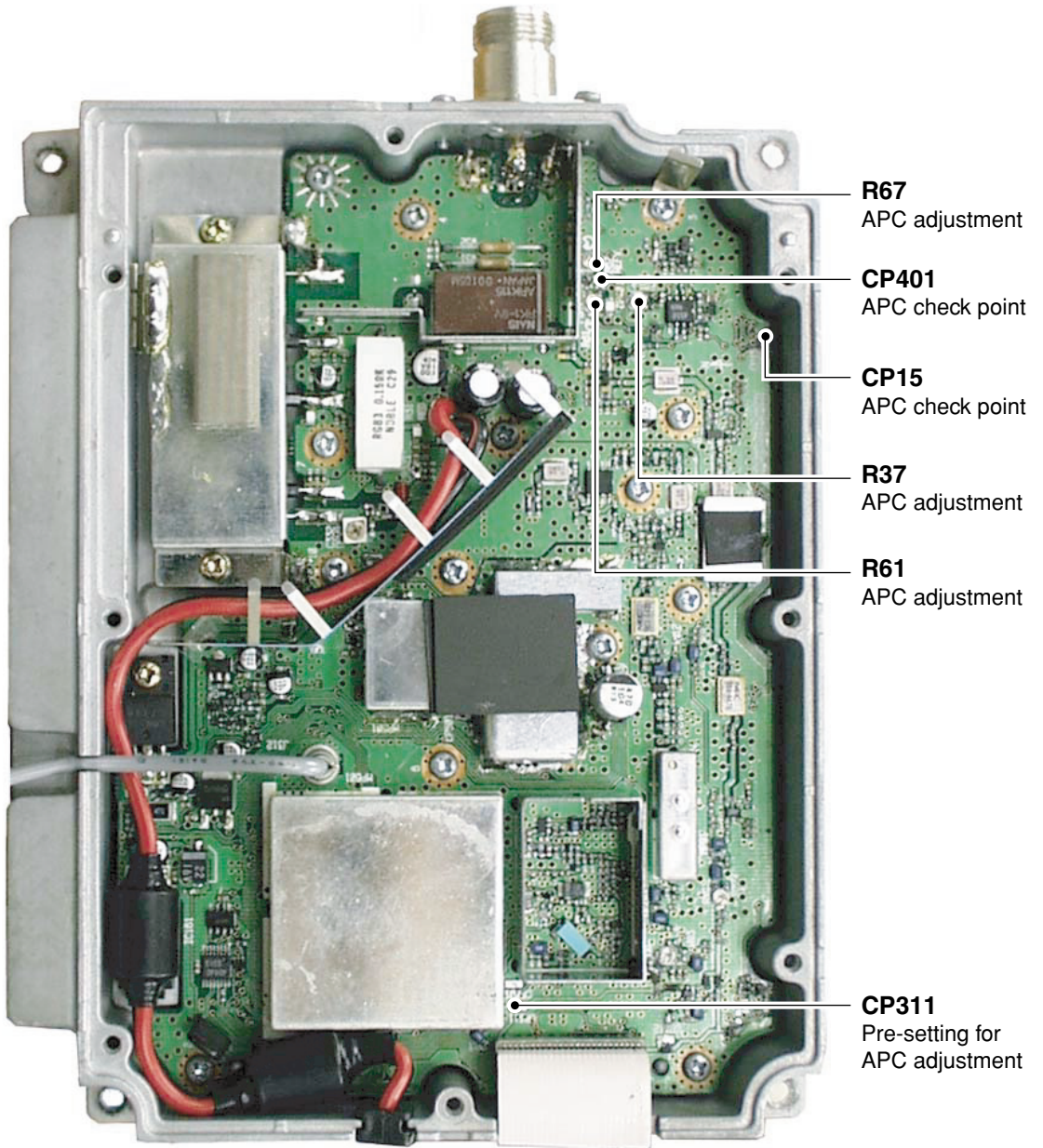

SECTION 6 PARTS LIST

6-1 IC-910

[FRONT UNIT]

REF NO.	ORDER NO.	DESCRIPTION	
W1	8900006700	CABLE	OPC-645 (N:6 L:60)
W2	8900006700	CABLE	OPC-645 (N:6 L:60)
W3	8900006700	CABLE	OPC-645 (N:6 L:60)
W4	8900009240	CABLE	OPC-909 (P=1 N=10 L=110)
W5	8900006700	CABLE	OPC-645 (N:6 L:60)
W6	8900006700	CABLE	OPC-645 (N:6 L:60)
EP1	6910012480	E.OTHER	RMS20-250-201-1R
EP2	6450001230	E.OTHER	HLJ0999-01-480

[DISPLAY BOARD]

REF NO.	ORDER NO.	DESCRIPTION	
IC1	1140009671	S.IC	M30622MAA-868FP
IC2	1130009970	S.IC	SED1540F0A
IC3	1130009100	S.IC	BU4052BCFV-E2
IC4	1130009100	S.IC	BU4052BCFV-E2
IC5	1130009100	S.IC	BU4052BCFV-E2
IC6	1140008650	S.IC	HN58X2464T1
IC7	1130009110	S.IC	S-80942ANMP-DD6-T2
IC8	1130006800	S.IC	TC7W08F (TE12L)
IC9	1130005720	S.IC	TC7W04F (TE12L)
IC10	1130007570	S.IC	BU4094BCFV-E2
IC11	1180000970	S.IC	AN78L05M-(E1)
IC201	1110004200	S.IC	NJM2360M-TE3
Q1	1540000550	S.TRANSISTOR	2SD1664 T100Q
Q11	1530002690	S.TRANSISTOR	2SC4116-GR (TE85R)
Q12	1510000770	S.TRANSISTOR	2SA1586-GR (TE85R)
Q13	1530002690	S.TRANSISTOR	2SC4116-GR (TE85R)
Q16	1530002690	S.TRANSISTOR	2SC4116-GR (TE85R)
Q17	1530002690	S.TRANSISTOR	2SC4116-GR (TE85R)
Q18	1590001050	S.TRANSISTOR	DTC114TUA T106
Q19	1590001050	S.TRANSISTOR	DTC114TUA T106
Q20	1590001050	S.TRANSISTOR	DTC114TUA T106
Q21	1590001050	S.TRANSISTOR	DTC114TUA T106
Q22	1590000720	S.TRANSISTOR	DTA144EUA T106
Q23	1590000720	S.TRANSISTOR	DTA144EUA T106
Q24	1520000650	S.TRANSISTOR	2SB1201-S-TL
Q25	1530002690	S.TRANSISTOR	2SC4116-GR (TE85R)
Q26	1590000720	S.TRANSISTOR	DTA144EUA T106
D1	1750000550	S.DIODE	1SS355 TE-17 [KOR]
D2	1750000550	S.DIODE	1SS355 TE-17 [USA-1], [AUS], [KOR] [EUR]
D3	1750000550	S.DIODE	1SS355 TE-17 except [USA-1]
D5	1750000550	S.DIODE	1SS355 TE-17 except [USA-1]
D6	1750000550	S.DIODE	1SS355 TE-17 except [USA-1]
D7	1750000550	S.DIODE	1SS355 TE-17 except [USA-1]
D9	1750000550	S.DIODE	1SS355 TE-17
D10	1790001610	S.DIODE	1SS385 (TE85L)
D13	1750000550	S.DIODE	1SS355 TE-17
D14	1160000080	S.DIODE	DAP202K T146
D15	1750000550	S.DIODE	1SS355 TE-17
D16	1750000550	S.DIODE	1SS355 TE-17
D17	1790001170	S.ZENER	MA8068-M (TX)
D20	1750000550	S.DIODE	1SS355 TE-17
D24	1750000550	S.DIODE	1SS355 TE-17
D25	1750000550	S.DIODE	1SS355 TE-17
D26	1750000550	S.DIODE	1SS355 TE-17
D27	1790001670	S.DIODE	RB706F-40T106
D28	1790001670	S.DIODE	RB706F-40T106
D29	1790001670	S.DIODE	RB706F-40T106
D34	1790001670	S.DIODE	RB706F-40T106
D35	1790001670	S.DIODE	RB706F-40T106
D36	1160000080	S.DIODE	DAP202K T146
D37	1750000550	S.DIODE	1SS355 TE-17

[DISPLAY BOARD]

REF NO.	ORDER NO.	DESCRIPTION	
D41	1750000550	S.DIODE	1SS355 TE-17
D42	1160000080	S.DIODE	DAP202K T146
D43	1160000080	S.DIODE	DAP202K T146
D44	1160000080	S.DIODE	DAP202K T146
D45	1160000080	S.DIODE	DAP202K T146
D46	1160000080	S.DIODE	DAP202K T146
D47	1160000080	S.DIODE	DAP202K T146
D48	1160000080	S.DIODE	DAP202K T146
D49	1160000080	S.DIODE	DAP202K T146
D50	1160000080	S.DIODE	DAP202K T146
D51	1160000080	S.DIODE	DAP202K T146
D52	1160000080	S.DIODE	DAP202K T146
D202	1790000670	S.DIODE	SB07-03C-TB
X1	6050010500	S.XTAL	CR-636 (14.7456 MHz)
L1	6200003950	S.COIL	HF50ACC 322513-T
L2	6200003950	S.COIL	HF50ACC 322513-T
L3	6200003950	S.COIL	HF50ACC 322513-T
L4	6200003950	S.COIL	HF50ACC 322513-T
L5	6200003950	S.COIL	HF50ACC 322513-T
L6	6200003950	S.COIL	HF50ACC 322513-T
L7	6200003950	S.COIL	HF50ACC 322513-T
L8	6200003950	S.COIL	HF50ACC 322513-T
L10	6200003950	S.COIL	HF50ACC 322513-T
L11	6200003330	S.COIL	NL 322522T-1R0J-3
L201	6200007030	S.COIL	SLF7032T-101MR45-2
L202	6200007030	S.COIL	SLF7032T-101MR45-2
L203	6200007030	S.COIL	SLF7032T-101MR45-2
R1	7030003440	S.RESISTOR	ERJ3GEYJ 102 V (1 kΩ)
R2	7030003640	S.RESISTOR	ERJ3GEYJ 473 V (47 kΩ)
R3	7030003640	S.RESISTOR	ERJ3GEYJ 473 V (47 kΩ)
R4	7030003640	S.RESISTOR	ERJ3GEYJ 473 V (47 kΩ)
R5	7030003640	S.RESISTOR	ERJ3GEYJ 473 V (47 kΩ)
R6	7030003640	S.RESISTOR	ERJ3GEYJ 473 V (47 kΩ)
R7	7030003640	S.RESISTOR	ERJ3GEYJ 473 V (47 kΩ)
R8	7030003640	S.RESISTOR	ERJ3GEYJ 473 V (47 kΩ)
R9	7030003640	S.RESISTOR	ERJ3GEYJ 473 V (47 kΩ)
R10	7210002230	TRIMMER	EVU-FLAEC2 B14
R11	7210002230	TRIMMER	EVU-FLAEC2 B14
R12	7030003200	S.RESISTOR	ERJ3GEYJ 100 V (10 Ω)
R13	7030003440	S.RESISTOR	ERJ3GEYJ 102 V (1 kΩ)
R14	7030003250	S.RESISTOR	ERJ3GEYJ 270 V (27 Ω)
R15	7030007990	S.RESISTOR	ERJ12YJ820U (82 Ω)
R16	7030007990	S.RESISTOR	ERJ12YJ820U (82 Ω)
R17	7030003520	S.RESISTOR	ERJ3GEYJ 472 V (4.7 kΩ)
R18	7030003520	S.RESISTOR	ERJ3GEYJ 472 V (4.7 kΩ)
R19	7030003680	S.RESISTOR	ERJ3GEYJ 104 V (100 kΩ)
R34	7030003560	S.RESISTOR	ERJ3GEYJ 103 V (10 kΩ)
R35	7030003560	S.RESISTOR	ERJ3GEYJ 103 V (10 kΩ)
R36	7030003680	S.RESISTOR	ERJ3GEYJ 104 V (100 kΩ)
R37	7030003630	S.RESISTOR	ERJ3GEYJ 393 V (39 kΩ)
R38	7030003560	S.RESISTOR	ERJ3GEYJ 103 V (10 kΩ)
R39	7030003640	S.RESISTOR	ERJ3GEYJ 473 V (47 kΩ)
R40	7030003680	S.RESISTOR	ERJ3GEYJ 104 V (100 kΩ)
R41	7030003360	S.RESISTOR	ERJ3GEYJ 221 V (220 Ω)
R42	7030003680	S.RESISTOR	ERJ3GEYJ 104 V (100 kΩ)
R43	7030003680	S.RESISTOR	ERJ3GEYJ 104 V (100 kΩ)
R44	7030003720	S.RESISTOR	ERJ3GEYJ 224 V (220 kΩ)
R45	7030003680	S.RESISTOR	ERJ3GEYJ 104 V (100 kΩ)
R46	7030003800	S.RESISTOR	ERJ3GEYJ 105 V (1 MΩ)
R47	7030003680	S.RESISTOR	ERJ3GEYJ 104 V (100 kΩ)
R48	7030003720	S.RESISTOR	ERJ3GEYJ 224 V (220 kΩ)
R49	7030003680	S.RESISTOR	ERJ3GEYJ 104 V (100 kΩ)
R50	7030003800	S.RESISTOR	ERJ3GEYJ 105 V (1 MΩ)
R51	7030003680	S.RESISTOR	ERJ3GEYJ 104 V (100 kΩ)
R52	7030003440	S.RESISTOR	ERJ3GEYJ 102 V (1 kΩ)
R53	7030003480	S.RESISTOR	ERJ3GEYJ 222 V (2.2 kΩ)
R54	7030003640	S.RESISTOR	ERJ3GEYJ 473 V (47 kΩ)
R55	7030003540	S.RESISTOR	ERJ3GEYJ 682 V (6.8 kΩ)
R56	7030003620	S.RESISTOR	ERJ3GEYJ 333 V (33 kΩ)

S.=Surface mount

[DISPLAY BOARD]

REF NO.	ORDER NO.	DESCRIPTION	
R57	7030003640	S.RESISTOR	ERJ3GEYJ 473 V (47 kΩ)
R58	7030003590	S.RESISTOR	ERJ3GEYJ 183 V (18 kΩ)
R59	7030003680	S.RESISTOR	ERJ3GEYJ 104 V (100 kΩ)
R60	7030003480	S.RESISTOR	ERJ3GEYJ 222 V (2.2 kΩ)
R61	7030003640	S.RESISTOR	ERJ3GEYJ 473 V (47 kΩ)
R66	7030003440	S.RESISTOR	ERJ3GEYJ 102 V (1 kΩ)
R67	7030003480	S.RESISTOR	ERJ3GEYJ 222 V (2.2 kΩ)
R68	7030003430	S.RESISTOR	ERJ3GEYJ 821 V (820 Ω)
R69	7030003640	S.RESISTOR	ERJ3GEYJ 473 V (47 kΩ)
R70	7030003640	S.RESISTOR	ERJ3GEYJ 473 V (47 kΩ)
R71	7030003440	S.RESISTOR	ERJ3GEYJ 102 V (1 kΩ)
R72	7030003480	S.RESISTOR	ERJ3GEYJ 222 V (2.2 kΩ)
R73	7030003430	S.RESISTOR	ERJ3GEYJ 821 V (820 Ω)
R74	7030000340	S.RESISTOR	MCR10EZJH 470 Ω (471)
R75	7030000330	S.RESISTOR	MCR10EZJH 390 Ω (391)
R76	7030000340	S.RESISTOR	MCR10EZJH 470 Ω (471)
R77	7030000330	S.RESISTOR	MCR10EZJH 390 Ω (391)
R78	7030003840	S.RESISTOR	ERJ3GEYJ 225 V (2.2 MΩ)
R79	7030003640	S.RESISTOR	ERJ3GEYJ 473 V (47 kΩ)
R80	7030003560	S.RESISTOR	ERJ3GEYJ 103 V (10 kΩ)
R81	7030003560	S.RESISTOR	ERJ3GEYJ 103 V (10 kΩ)
R82	7030003560	S.RESISTOR	ERJ3GEYJ 103 V (10 kΩ)
R83	7030003450	S.RESISTOR	ERJ3GEYJ 122 V (1.2 kΩ)
R87	7030000270	S.RESISTOR	MCR10EZJH 120 Ω (121)
R88	7030000270	S.RESISTOR	MCR10EZJH 120 Ω (121)
R90	7030000140	S.RESISTOR	MCR10EZJH 10 Ω (100)
R91	7030003560	S.RESISTOR	ERJ3GEYJ 103 V (10 kΩ)
R92	7030003630	S.RESISTOR	ERJ3GEYJ 393 V (39 kΩ)
R93	7030003550	S.RESISTOR	ERJ3GEYJ 822 V (8.2 kΩ)
R94	7030003570	S.RESISTOR	ERJ3GEYJ 123 V (12 kΩ)
R95	7030003400	S.RESISTOR	ERJ3GEYJ 471 V (470 Ω)
R96	7030003640	S.RESISTOR	ERJ3GEYJ 473 V (47 kΩ)
R97	7030003680	S.RESISTOR	ERJ3GEYJ 104 V (100 kΩ)
R98	7030003410	S.RESISTOR	ERJ3GEYJ 561 V (560 Ω)
R100	7030003680	S.RESISTOR	ERJ3GEYJ 104 V (100 kΩ)
R101	7030003680	S.RESISTOR	ERJ3GEYJ 104 V (100 kΩ)
R102	7030003440	S.RESISTOR	ERJ3GEYJ 102 V (1 kΩ)
R103	7030003440	S.RESISTOR	ERJ3GEYJ 102 V (1 kΩ)
R104	7030003360	S.RESISTOR	ERJ3GEYJ 221 V (220 Ω)
R105	7030003360	S.RESISTOR	ERJ3GEYJ 221 V (220 Ω)
R106	7030003360	S.RESISTOR	ERJ3GEYJ 221 V (220 Ω)
R107	7030003360	S.RESISTOR	ERJ3GEYJ 221 V (220 Ω)
R108	7030003360	S.RESISTOR	ERJ3GEYJ 221 V (220 Ω)
R109	7030003360	S.RESISTOR	ERJ3GEYJ 221 V (220 Ω)
R110	7030003360	S.RESISTOR	ERJ3GEYJ 221 V (220 Ω)
R111	7030003680	S.RESISTOR	ERJ3GEYJ 104 V (100 kΩ)
R112	7030003680	S.RESISTOR	ERJ3GEYJ 104 V (100 kΩ)
R113	7030003360	S.RESISTOR	ERJ3GEYJ 221 V (220 Ω)
R114	7030003640	S.RESISTOR	ERJ3GEYJ 473 V (47 kΩ)
R115	7030003640	S.RESISTOR	ERJ3GEYJ 473 V (47 kΩ)
R116	7030003640	S.RESISTOR	ERJ3GEYJ 473 V (47 kΩ)
R117	70300006100	S.RESISTOR	RR0816P-183-D (18 kΩ)
R118	7030003560	S.RESISTOR	ERJ3GEYJ 103 V (10 kΩ)
R123	7030003360	S.RESISTOR	ERJ3GEYJ 221 V (220 Ω)
R124	7030003360	S.RESISTOR	ERJ3GEYJ 221 V (220 Ω)
R125	7030003440	S.RESISTOR	ERJ3GEYJ 102 V (1 kΩ)
R126	7030003440	S.RESISTOR	ERJ3GEYJ 102 V (1 kΩ)
R127	7030003360	S.RESISTOR	ERJ3GEYJ 221 V (220 Ω)
R128	7030003360	S.RESISTOR	ERJ3GEYJ 221 V (220 Ω)
R129	7030003440	S.RESISTOR	ERJ3GEYJ 102 V (1 kΩ)
R130	7030003440	S.RESISTOR	ERJ3GEYJ 102 V (1 kΩ)
R131	7030003360	S.RESISTOR	ERJ3GEYJ 221 V (220 Ω)
R132	7030003360	S.RESISTOR	ERJ3GEYJ 221 V (220 Ω)
R133	7030003360	S.RESISTOR	ERJ3GEYJ 221 V (220 Ω)
R134	7030003360	S.RESISTOR	ERJ3GEYJ 221 V (220 Ω)
R135	7030003360	S.RESISTOR	ERJ3GEYJ 221 V (220 Ω)
R136	7030003360	S.RESISTOR	ERJ3GEYJ 221 V (220 Ω)
R137	7030003360	S.RESISTOR	ERJ3GEYJ 221 V (220 Ω)
R138	7030003360	S.RESISTOR	ERJ3GEYJ 221 V (220 Ω)
R139	7030003800	S.RESISTOR	ERJ3GEYJ 105 V (1 MΩ)
R140	70300006100	S.RESISTOR	RR0816P-183-D (18 kΩ)
R141	7030003800	S.RESISTOR	ERJ3GEYJ 105 V (1 MΩ)
R150	70300006100	S.RESISTOR	RR0816P-183-D (18 kΩ)
R151	7030003360	S.RESISTOR	ERJ3GEYJ 221 V (220 Ω)
R152	7030003360	S.RESISTOR	ERJ3GEYJ 221 V (220 Ω)
R153	7030003360	S.RESISTOR	ERJ3GEYJ 221 V (220 Ω)
R154	7030003360	S.RESISTOR	ERJ3GEYJ 221 V (220 Ω)
R155	7030003360	S.RESISTOR	ERJ3GEYJ 221 V (220 Ω)
R156	7030003360	S.RESISTOR	ERJ3GEYJ 221 V (220 Ω)
R157	7030003360	S.RESISTOR	ERJ3GEYJ 221 V (220 Ω)
R158	7030004050	S.RESISTOR	ERJ3GEYJ 1R0 V (1 Ω)
R159	7030003360	S.RESISTOR	ERJ3GEYJ 221 V (220 Ω)

[DISPLAY BOARD]

REF NO.	ORDER NO.	DESCRIPTION	
R160	7030003360	S.RESISTOR	ERJ3GEYJ 221 V (220 Ω)
R161	7030003360	S.RESISTOR	ERJ3GEYJ 221 V (220 Ω)
R162	7030003360	S.RESISTOR	ERJ3GEYJ 221 V (220 Ω)
R163	7030003360	S.RESISTOR	ERJ3GEYJ 221 V (220 Ω)
R164	7030003360	S.RESISTOR	ERJ3GEYJ 221 V (220 Ω)
R165	7030003360	S.RESISTOR	ERJ3GEYJ 221 V (220 Ω)
R166	7030003360	S.RESISTOR	ERJ3GEYJ 221 V (220 Ω)
R167	7030003360	S.RESISTOR	ERJ3GEYJ 221 V (220 Ω)
R168	7030003360	S.RESISTOR	ERJ3GEYJ 221 V (220 Ω)
R169	7030003360	S.RESISTOR	ERJ3GEYJ 221 V (220 Ω)
R170	7030003360	S.RESISTOR	ERJ3GEYJ 221 V (220 Ω)
R171	7030003360	S.RESISTOR	ERJ3GEYJ 221 V (220 Ω)
R172	7030003360	S.RESISTOR	ERJ3GEYJ 221 V (220 Ω)
R173	7030003680	S.RESISTOR	ERJ3GEYJ 104 V (100 kΩ)
R174	7030003680	S.RESISTOR	ERJ3GEYJ 104 V (100 kΩ)
R175	7030003680	S.RESISTOR	ERJ3GEYJ 104 V (100 kΩ)
R176	70300006100	S.RESISTOR	RR0816P-183-D (18 kΩ)
R178	7030003440	S.RESISTOR	ERJ3GEYJ 102 V (1 kΩ)
R179	7030003440	S.RESISTOR	ERJ3GEYJ 102 V (1 kΩ)
R180	7030003640	S.RESISTOR	ERJ3GEYJ 473 V (47 kΩ)
R181	7030003360	S.RESISTOR	ERJ3GEYJ 221 V (220 Ω)
R182	7030003360	S.RESISTOR	ERJ3GEYJ 221 V (220 Ω)
R183	7030003560	S.RESISTOR	ERJ3GEYJ 103 V (10 kΩ)
R184	7030003360	S.RESISTOR	ERJ3GEYJ 221 V (220 Ω)
R185	7030003640	S.RESISTOR	ERJ3GEYJ 473 V (47 kΩ)
R186	7030003440	S.RESISTOR	ERJ3GEYJ 102 V (1 kΩ)
R187	7030003440	S.RESISTOR	ERJ3GEYJ 102 V (1 kΩ)
R188	7030003440	S.RESISTOR	ERJ3GEYJ 102 V (1 kΩ)
R189	7030003560	S.RESISTOR	ERJ3GEYJ 103 V (10 kΩ)
R190	7030003560	S.RESISTOR	ERJ3GEYJ 103 V (10 kΩ)]
R201	7030000040	S.RESISTOR	MCR10EZJH 1.5 Ω (1R5)
R202	7030000040	S.RESISTOR	MCR10EZJH 1.5 Ω (1R5)
R203	7030006601	S.RESISTOR	ERA3YED 272V
R204	7030006091	S.RESISTOR	ERA3YED 822V
R205	7030003680	S.RESISTOR	ERJ3GEYJ 104 V (100 kΩ)
C1	4030006860	S.CERAMIC	C1608 JB 1H 102K-T-A
C2	4030011600	S.CERAMIC	C1608 JB 1C 104KT-N
C3	4030011600	S.CERAMIC	C1608 JB 1C 104KT-N
C4	4030011600	S.CERAMIC	C1608 JB 1C 104KT-N
C5	4030006860	S.CERAMIC	C1608 JB 1H 102K-T-A
C6	4030006860	S.CERAMIC	C1608 JB 1H 102K-T-A
C11	4030011600	S.CERAMIC	C1608 JB 1C 104KT-N
C12	4030006860	S.CERAMIC	C1608 JB 1H 102K-T-A
C13	4030006860	S.CERAMIC	C1608 JB 1H 102K-T-A
C14	4030011600	S.CERAMIC	C1608 JB 1C 104KT-N
C15	4030008890	S.CERAMIC	C1608 JB 1C 273K-T-A
C16	4030006860	S.CERAMIC	C1608 JB 1H 102K-T-A
C17	4030007020	S.CERAMIC	C1608 CH 1H 120J-T-A
C18	4030007020	S.CERAMIC	C1608 CH 1H 120J-T-A
C19	4030006860	S.CERAMIC	C1608 JB 1H 102K-T-A
C20	4030007130	S.CERAMIC	C1608 CH 1H 101J-T-A
C21	4030011600	S.CERAMIC	C1608 JB 1C 104KT-N
C22	4030007130	S.CERAMIC	C1608 CH 1H 101J-T-A
C23	4030011600	S.CERAMIC	C1608 JB 1C 104KT-N
C24	4030006860	S.CERAMIC	C1608 JB 1H 102K-T-A
C25	4030006860	S.CERAMIC	C1608 JB 1H 102K-T-A
C27	4030006860	S.CERAMIC	C1608 JB 1H 102K-T-A
C29	4030006860	S.CERAMIC	C1608 JB 1H 102K-T-A
C30	4030006860	S.CERAMIC	C1608 JB 1H 102K-T-A
C31	4030006860	S.CERAMIC	C1608 JB 1H 102K-T-A
C32	4030006860	S.CERAMIC	C1608 JB 1H 102K-T-A
C33	4030006860	S.CERAMIC	C1608 JB 1H 102K-T-A
C34	4030006860	S.CERAMIC	C1608 JB 1H 102K-T-A
C36	4030011600	S.CERAMIC	C1608 JB 1C 104KT-N
C37	4030011600	S.CERAMIC	C1608 JB 1C 104KT-N
C38	4030011600	S.CERAMIC	C1608 JB 1C 104KT-N
C39	4030011600	S.CERAMIC	C1608 JB 1C 104KT-N
C40	4510006260	S.ELECTROLYTIC	ECEV1AA471UP
C41	4030011600	S.CERAMIC	C1608 JB 1C 104KT-N
C42	4030011600	S.CERAMIC	C1608 JB 1C 104KT-N
C46	4030011600	S.CERAMIC	C1608 JB 1C 104KT-N
C47	4510004630	S.ELECTROLYTIC	ECEV1CA100SR
C48	4030011600	S.CERAMIC	C1608 JB 1C 104KT-N
C49	4030011600	S.CERAMIC	C1608 JB 1C 104KT-N
C50	4510004630	S.ELECTROLYTIC	ECEV1CA100SR
C51	4510004630	S.ELECTROLYTIC	ECEV1CA100SR
C52	4030006860	S.CERAMIC	C1608 JB 1H 102K-T-A
C53	4030006860	S.CERAMIC	C1608 JB 1H 102K-T-A
C54	4030006860	S.CERAMIC	C1608 JB 1H 102K-T-A
C55	4510006220	S.ELECTROLYTIC	ECEV1CA101UP

S.=Surface mount

[DISPLAY BOARD]

REF NO.	ORDER NO.	DESCRIPTION	
C56	4030006860	S.CERAMIC	C1608 JB 1H 102K-T-A
C57	4030012610	S.CERAMIC	C2012 JB 1C 474K-T-A
C71	4030006860	S.CERAMIC	C1608 JB 1H 102K-T-A
C72	4030006860	S.CERAMIC	C1608 JB 1H 102K-T-A
C73	4030006860	S.CERAMIC	C1608 JB 1H 102K-T-A
C74	4030006860	S.CERAMIC	C1608 JB 1H 102K-T-A
C75	4030006860	S.CERAMIC	C1608 JB 1H 102K-T-A
C86	4030012600	S.CERAMIC	C2012 JB 1A 105M-T-A
C88	4030006860	S.CERAMIC	C1608 JB 1H 102K-T-A
C89	4030006860	S.CERAMIC	C1608 JB 1H 102K-T-A
C90	4030006860	S.CERAMIC	C1608 JB 1H 102K-T-A
C94	4030011600	S.CERAMIC	C1608 JB 1C 104KT-N
C119	4030007130	S.CERAMIC	C1608 CH 1H 101J-T-A
C163	4030010760	S.CERAMIC	C1608 CH 1H 331J-T-A
C164	4030010760	S.CERAMIC	C1608 CH 1H 331J-T-A
C168	4030010760	S.CERAMIC	C1608 CH 1H 331J-T-A
C181	4030010760	S.CERAMIC	C1608 CH 1H 331J-T-A
C182	4030010760	S.CERAMIC	C1608 CH 1H 331J-T-A
C204	4510006220	S.ELECTROLYTIC	ECEV1CA101UP
C205	4030011600	S.CERAMIC	C1608 JB 1C 104KT-N
C206	4510006220	S.ELECTROLYTIC	ECEV1CA101UP
C207	4030011600	S.CERAMIC	C1608 JB 1C 104KT-N
C208	4030007150	S.CERAMIC	C1608 CH 1H 151J-T-A
C209	4510007580	S.ELECTROLYTIC	EEVFC1C101P
C210	4030011600	S.CERAMIC	C1608 JB 1C 104KT-N
C211	4030011600	S.CERAMIC	C1608 JB 1C 104KT-N
C212	4510006220	S.ELECTROLYTIC	ECEV1CA101UP
C213	4030011600	S.CERAMIC	C1608 JB 1C 104KT-N
C216	4030011600	S.CERAMIC	C1608 JB 1C 104KT-N
C527	4030011600	S.CERAMIC	C1608 JB 1C 104KT-N
C536	4030011600	S.CERAMIC	C1608 JB 1C 104KT-N
C538	4030011600	S.CERAMIC	C1608 JB 1C 104KT-N
C541	4030011600	S.CERAMIC	C1608 JB 1C 104KT-N
C542	4030011600	S.CERAMIC	C1608 JB 1C 104KT-N
C547	4030011600	S.CERAMIC	C1608 JB 1C 104KT-N
C548	4030011600	S.CERAMIC	C1608 JB 1C 104KT-N
C549	4030011600	S.CERAMIC	C1608 JB 1C 104KT-N
C576	4030011600	S.CERAMIC	C1608 JB 1C 104KT-N
C577	4030011600	S.CERAMIC	C1608 JB 1C 104KT-N
C600	4030011600	S.CERAMIC	C1608 JB 1C 104KT-N
J2	6510022570	S.CONNECTOR	06FMN-BMTTR-A-TBT
J3	6510022570	S.CONNECTOR	06FMN-BMTTR-A-TBT
J4	6510018970	S.CONNECTOR	B4B-PH-SM3-TB
J5	6510022570	S.CONNECTOR	06FMN-BMTTR-A-TBT
J6	6510022620	S.CONNECTOR	10FMN-BMTTR-A-TBT
J7	6510021720	S.CONNECTOR	30FLT-SM1-TB
J8	6510021720	S.CONNECTOR	30FLT-SM1-TB
J9	6510022540	S.CONNECTOR	20FMN-BMTTR-A-TBT
J10	6510022290	S.CONNECTOR	06FMN-BMTTR-TBT
J11	6510022290	S.CONNECTOR	06FMN-BMTTR-TBT
J12	6510022190	S.CONNECTOR	B3B-PH-SM3-TB
J14	6510018950	S.CONNECTOR	B7B-PH-SM3-TB
DS1	5040002680	S.LED	TLGE1002
DS2	5040002680	S.LED	TLGE1002
DS3	5040002680	S.LED	TLGE1002
DS4	5040002680	S.LED	TLGE1002
DS5	5040002680	S.LED	TLGE1002
DS6	5040002680	S.LED	TLGE1002
DS7	5040002680	S.LED	TLGE1002
DS8	5040002680	S.LED	TLGE1002
DS9	5040002680	S.LED	TLGE1002
DS10	5040002680	S.LED	TLGE1002
DS11	5040002680	S.LED	TLGE1002
DS12	5040002680	S.LED	TLGE1002
DS13	5040002680	S.LED	TLGE1002
DS14	5040002680	S.LED	TLGE1002
DS15	5040002680	S.LED	TLGE1002
DS16	5040002680	S.LED	TLGE1002
DS17	5040002680	S.LED	TLGE1002
DS18	5040002680	S.LED	TLGE1002
DS19	5040002680	S.LED	TLGE1002
DS20	5040002680	S.LED	TLGE1002
DS21	5040002680	S.LED	TLGE1002
DS22	5040002680	S.LED	TLGE1002
DS23	5040002680	S.LED	TLGE1002
DS24	5040002680	S.LED	TLGE1002
DS31	5030001840	LCD	A0095
DS32	5040001870	S.LED	SEC 2462C

[DISPLAY BOARD]

REF NO.	ORDER NO.	DESCRIPTION	
DS33	5040001870	S.LED	SEC 2462C
W1	7030003860	S.JUMPER	ERJ3GE JPW V
W2	7030003860	S.JUMPER	ERJ3GE JPW V
EP1	6910012350	S.BEAD	MMZ1608Y 102BT
EP2	6910012350	S.BEAD	MMZ1608Y 102BT
EP3	6910012350	S.BEAD	MMZ1608Y 102BT
EP4	6910012350	S.BEAD	MMZ1608Y 102BT
EP5	6910012350	S.BEAD	MMZ1608Y 102BT
EP11	0910052635	PCB	B 5456E
EP31	8930052490	LCD CONTACT	SRCN-2355-SP-N-W

[FUNC BOARD]

REF NO.	ORDER NO.	DESCRIPTION	
D1	1160000080	S.DIODE	DAP202K T146
D2	1160000080	S.DIODE	DAP202K T146
D3	1160000080	S.DIODE	DAP202K T146
J1	6510022570	S.CONNECTOR	06FMN-BMTTR-A-TBT
EP1	0910052641	PCB	B 5458A

[VR-A BOARD]

REF NO.	ORDER NO.	DESCRIPTION	
R1	7210002970	VARIABLE	RV-314 (RK0972210 10KB/10KB)
J1	6510022570	S.CONNECTOR	06FMN-BMTTR-A-TBT
EP1	0910052652	PCB	B 5460B

[VR-B BOARD]

REF NO.	ORDER NO.	DESCRIPTION	
R1	7210002970	VARIABLE	RV-314 (RK0972210 10KB/10KB)
J1	6510022570	S.CONNECTOR	06FMN-BMTTR-A-TBT
EP1	0910053410	PCB	B 5582

S.=Surface mount

[RIT BOARD]

REF NO.	ORDER NO.	DESCRIPTION	
R2	7210003090	VARIABLE	RV-316 (RK0972210C05 10KB/10KB)
J1	6510022570	S.CONNECTOR	06FMN-BMTTR-A-TBT
EP1	0910052661	PCB	B 5461A

[JACK BOARD]

REF NO.	ORDER NO.	DESCRIPTION	
L1	6200003950	S.COIL	HF50ACC 322513-T
R1	7030006070	S.RESISTOR	ERJ12YJ101U (100 Ω)
R2	7030006070	S.RESISTOR	ERJ12YJ101U (100 Ω)
C1	4030006860	S.CERAMIC	C1608 JB 1H 102K-T-A
C2	4030006860	S.CERAMIC	C1608 JB 1H 102K-T-A
C3	4030006860	S.CERAMIC	C1608 JB 1H 102K-T-A
J1	6450001250	CONNECTOR	HLJ4306-01-3070
J2	6510022570	S.CONNECTOR	06FMN-BMTTR-A-TBT
EP1	0910052671	PCB	B 5462A

[MIC BOARD]

REF NO.	ORDER NO.	DESCRIPTION	
J1	6510000190	CONNECTOR	FM214-8SS (P)
J2	6510022620	S.CONNECTOR	10FMN-BMTTR-A-TBT
EP1	0910052682	PCB	B 5463B

[PLL UNIT]

REF NO.	ORDER NO.	DESCRIPTION	
IC1	1130007700	S.IC	BU4094BCF-T1
IC12	1110001900	S.IC	μPC4570G2-T1
IC101	1130004830	S.IC	TC7SU04F (TE85R)
IC131	1140007880	S.IC	TC190G08AF-0046-Z/SC-1246A
IC161	1110001900	S.IC	μPC4570G2-T1
IC271	1110004460	S.IC	μPB1509GV-E1
IC301	1130004830	S.IC	TC7SU04F (TE85R)
IC331	1140007880	S.IC	TC190G08AF-0046-Z/SC-1246A
IC471	1110004460	S.IC	μPB1509GV-E1
IC501	1180001070	S.IC	TA7805F (TE16L)
IC601	1140004550	S.IC	M65343FP/SC1287
IC701	1140004550	S.IC	M65343FP/SC1287
Q153	1590000660	S.TRANSISTOR	DTC144TU T107
Q154	1590000660	S.TRANSISTOR	DTC144TU T107
Q161	1590000720	S.TRANSISTOR	DTA144EUA T106
Q181	1540000410	S.TRANSISTOR	2SD2345 (TX) S
Q191	1560000650	S.FET	2SK1577-2-T7
Q192	1530003310	S.TRANSISTOR	2SC5107-O (TE85R)
Q261	1530002060	S.TRANSISTOR	2SC4081 T107 R
Q271	1530002060	S.TRANSISTOR	2SC4081 T107 R
Q272	1530003310	S.TRANSISTOR	2SC5107-O (TE85R)
Q361	1590000720	S.TRANSISTOR	DTA144EUA T106
Q381	1540000410	S.TRANSISTOR	2SD2345 (TX) S
Q391	1560000650	S.FET	2SK1577-2-T7
Q392	1530003310	S.TRANSISTOR	2SC5107-O (TE85R)
Q471	1530003310	S.TRANSISTOR	2SC5107-O (TE85R)
Q472	1530003310	S.TRANSISTOR	2SC5107-O (TE85R)
Q501	1530002600	S.TRANSISTOR	2SC4215-O (TE85R)
Q541	1530002600	S.TRANSISTOR	2SC4215-O (TE85R)
Q551	1530003310	S.TRANSISTOR	2SC5107-O (TE85R)
Q602	1530002060	S.TRANSISTOR	2SC4081 T107 R
Q702	1530002060	S.TRANSISTOR	2SC4081 T107 R
D161	1750000550	S.DIODE	1SS355 TE-17
D181	1750000550	S.DIODE	1SS355 TE-17
D191	1720000590	S.VARICAP	MA357 (TX)
D192	1720000590	S.VARICAP	MA357 (TX)
D193	1720000590	S.VARICAP	MA357 (TX)
D194	1720000590	S.VARICAP	MA357 (TX)
D361	1750000550	S.DIODE	1SS355 TE-17
D381	1750000550	S.DIODE	1SS355 TE-17
D391	1720000590	S.VARICAP	MA357 (TX)
D392	1720000590	S.VARICAP	MA357 (TX)
D393	1720000590	S.VARICAP	MA357 (TX)
D394	1720000590	S.VARICAP	MA357 (TX)
X512	6050008710	XTAL	CR-452 (30.200 MHz)
L1	6200005010	S.COIL	NL 252018T-100J
L101	6200005030	S.COIL	NL 252018T-180J
L102	6200005040	S.COIL	NL 252018T-220J
L103	6200007020	S.COIL	NL 252018T-270J
L131	6200001980	S.COIL	NL 252018T-1R0J
L191	6200002040	S.COIL	NL 252018T-101J
L193	6130002990	S.COIL	LB-345 (5203-T005)
L194	6200003000	S.COIL	NL 322522T-R22J-3
L195	6200009350	S.COIL	ELJRE R22G-F3
L212	6200005720	S.COIL	ELJRE 33NG-F
L213	6200005740	S.COIL	ELJRE 47NG-F
L214	6200006990	S.COIL	ELJRE 56NG-F
L271	6200005010	S.COIL	NL 252018T-100J
L273	6200005740	S.COIL	ELJRE 47NG-F
L301	6200005030	S.COIL	NL 252018T-180J
L302	6200005040	S.COIL	NL 252018T-220J
L303	6200003160	S.COIL	NL 322522T-270J
L331	6200009690	S.COIL	LQH 4C 101K04
L332	6200008940	S.COIL	LQH 3N 331K 34
L391	6200000150	S.COIL	NL 322522T-1R0M
L392	6200009260	S.COIL	C3328A-5N0J-A
L393	6200009260	S.COIL	C3328A-5N0J-A
L394	6200002840	S.COIL	NL 252018T-R22J
L395	6200009410	S.COIL	C3328A-2N5K-A
L397	6200001980	S.COIL	NL 252018T-1R0J
L399	6200005720	S.COIL	ELJRE 33NG-F
L421	6200005700	S.COIL	ELJRE 22NG-F
L422	6200005700	S.COIL	ELJRE 22NG-F
L423	6200005720	S.COIL	ELJRE 33NG-F

S.=Surface mount

[PLL UNIT]

REF NO.	ORDER NO.	DESCRIPTION	
L424	6200005720	S.COIL	ELJRE 33NG-F
L425	6200005700	S.COIL	ELJRE 22NG-F
L471	6200005010	S.COIL	NL 252018T-100J
L473	6200005720	S.COIL	ELJRE 33NG-F
L474	6200001830	S.COIL	NL 322522T-100J
L511	6200001830	S.COIL	NL 322522T-100J
L541	6200004950	S.COIL	NL 252018T-1R8J
L551	6150005090	S.COIL	LS-536
L552	6150005090	S.COIL	LS-536
L553	6200002180	S.COIL	NL 252018T-R12J
L599	6200005010	S.COIL	NL 252018T-100J
L601	6200003660	S.COIL	NL 252018T-R68J
L602	6200002610	S.COIL	NL 252018T-R47J
L604	6200002000	S.COIL	NL 252018T-3R3J
L700	6200005010	S.COIL	NL 252018T-100J
L701	6200003660	S.COIL	NL 252018T-R68J
L702	6200002610	S.COIL	NL 252018T-R47J
L704	6200002000	S.COIL	NL 252018T-3R3J
R8	7030003360	S.RESISTOR	ERJ3GEYJ 221 V (220 Ω)
R9	7030003360	S.RESISTOR	ERJ3GEYJ 221 V (220 Ω)
R10	7030003360	S.RESISTOR	ERJ3GEYJ 221 V (220 Ω)
R11	7030003360	S.RESISTOR	ERJ3GEYJ 221 V (220 Ω)
R12	7030003360	S.RESISTOR	ERJ3GEYJ 221 V (220 Ω)
R13	7030003440	S.RESISTOR	ERJ3GEYJ 102 V (1 kΩ)
R14	7030003440	S.RESISTOR	ERJ3GEYJ 102 V (1 kΩ)
R19	7030003360	S.RESISTOR	ERJ3GEYJ 221 V (220 Ω)
R101	7030007230	S.RESISTOR	ERA3YED 102V
R102	7030007230	S.RESISTOR	ERA3YED 102V
R103	7030007230	S.RESISTOR	ERA3YED 102V
R104	7030007230	S.RESISTOR	ERA3YED 102V
R105	7030007230	S.RESISTOR	ERA3YED 102V
R106	7030007230	S.RESISTOR	ERA3YED 102V
R107	7030007210	S.RESISTOR	ERA3YEB 102V
R108	7030007210	S.RESISTOR	ERA3YEB 102V
R109	7030007210	S.RESISTOR	ERA3YEB 102V
R110	7030007210	S.RESISTOR	ERA3YEB 102V
R111	7030007210	S.RESISTOR	ERA3YEB 102V
R112	7030007220	S.RESISTOR	ERA3YED 202V
R113	7030007220	S.RESISTOR	ERA3YED 202V
R114	7030007220	S.RESISTOR	ERA3YED 202V
R115	7030007220	S.RESISTOR	ERA3YED 202V
R116	7030007220	S.RESISTOR	ERA3YED 202V
R117	7030007220	S.RESISTOR	ERA3YED 202V
R118	7030007220	S.RESISTOR	ERA3YED 202V
R119	7030007220	S.RESISTOR	ERA3YED 202V
R120	7030007200	S.RESISTOR	ERA3YEB 202V
R121	7030007200	S.RESISTOR	ERA3YEB 202V
R122	7030007200	S.RESISTOR	ERA3YEB 202V
R123	7030007200	S.RESISTOR	ERA3YEB 202V
R124	7030007200	S.RESISTOR	ERA3YEB 202V
R125	7030003440	S.RESISTOR	ERJ3GEYJ 102 V (1 kΩ)
R126	7030003340	S.RESISTOR	ERJ3GEYJ 151 V (150 Ω)
R127	7030003800	S.RESISTOR	ERJ3GEYJ 105 V (1 MΩ)
R129	7030003320	S.RESISTOR	ERJ3GEYJ 101 V (100 Ω)
R130	7030003440	S.RESISTOR	ERJ3GEYJ 102 V (1 kΩ)
R131	7030003800	S.RESISTOR	ERJ3GEYJ 105 V (1 MΩ)
R132	7030003440	S.RESISTOR	ERJ3GEYJ 102 V (1 kΩ)
R133	7030003440	S.RESISTOR	ERJ3GEYJ 102 V (1 kΩ)
R134	7030003680	S.RESISTOR	ERJ3GEYJ 104 V (100 kΩ)
R135	7030003360	S.RESISTOR	ERJ3GEYJ 221 V (220 Ω)
R136	7030003440	S.RESISTOR	ERJ3GEYJ 102 V (1 kΩ)
R137	7030003440	S.RESISTOR	ERJ3GEYJ 102 V (1 kΩ)
R138	7030003440	S.RESISTOR	ERJ3GEYJ 102 V (1 kΩ)
R139	7030003360	S.RESISTOR	ERJ3GEYJ 221 V (220 Ω)
R140	7030003360	S.RESISTOR	ERJ3GEYJ 221 V (220 Ω)
R160	7030003360	S.RESISTOR	ERJ3GEYJ 221 V (220 Ω)
R161	7030004050	S.RESISTOR	ERJ3GEYJ 1R0 V (1 Ω)
R162	7030004050	S.RESISTOR	ERJ3GEYJ 1R0 V (1 Ω)
R163	7030003320	S.RESISTOR	ERJ3GEYJ 101 V (100 Ω)
R164	7030003560	S.RESISTOR	ERJ3GEYJ 103 V (10 kΩ)
R165	7030003560	S.RESISTOR	ERJ3GEYJ 103 V (10 kΩ)
R166	7030003360	S.RESISTOR	ERJ3GEYJ 221 V (220 Ω)
R167	7030003320	S.RESISTOR	ERJ3GEYJ 101 V (100 Ω)
R168	7030003360	S.RESISTOR	ERJ3GEYJ 221 V (220 Ω)
R169	7030003440	S.RESISTOR	ERJ3GEYJ 102 V (1 kΩ)
R170	7030003840	S.RESISTOR	ERJ3GEYJ 225 V (2.2 MΩ)
R171	7030003560	S.RESISTOR	ERJ3GEYJ 103 V (10 kΩ)
R172	7030003560	S.RESISTOR	ERJ3GEYJ 103 V (10 kΩ)
R181	7030003440	S.RESISTOR	ERJ3GEYJ 102 V (1 kΩ)
R191	7030003440	S.RESISTOR	ERJ3GEYJ 102 V (1 kΩ)

[PLL UNIT]

REF NO.	ORDER NO.	DESCRIPTION	
R192	7030003280	S.RESISTOR	ERJ3GEYJ 470 V (47 Ω)
R193	7030003440	S.RESISTOR	ERJ3GEYJ 102 V (1 kΩ)
R194	7030003620	S.RESISTOR	ERJ3GEYJ 333 V (33 kΩ)
R195	7030003360	S.RESISTOR	ERJ3GEYJ 221 V (220 Ω)
R211	7030003220	S.RESISTOR	ERJ3GEYJ 150 V (15 Ω)
R212	7030003300	S.RESISTOR	ERJ3GEYJ 680 V (68 Ω)
R213	7030003220	S.RESISTOR	ERJ3GEYJ 150 V (15 Ω)
R252	7030003340	S.RESISTOR	ERJ3GEYJ 151 V (150 Ω)
R253	7030003270	S.RESISTOR	ERJ3GEYJ 390 V (39 Ω)
R254	7030003340	S.RESISTOR	ERJ3GEYJ 151 V (150 Ω)
R261	7030003320	S.RESISTOR	ERJ3GEYJ 101 V (100 Ω)
R262	7030003640	S.RESISTOR	ERJ3GEYJ 473 V (47 kΩ)
R263	7030003380	S.RESISTOR	ERJ3GEYJ 331 V (330 Ω)
R267	7030003440	S.RESISTOR	ERJ3GEYJ 102 V (1 kΩ)
R268	7030003350	S.RESISTOR	ERJ3GEYJ 181 V (180 Ω)
R271	7030003400	S.RESISTOR	ERJ3GEYJ 471 V (470 Ω)
R272	7030003360	S.RESISTOR	ERJ3GEYJ 221 V (220 Ω)
R273	7030003640	S.RESISTOR	ERJ3GEYJ 473 V (47 kΩ)
R274	7030003360	S.RESISTOR	ERJ3GEYJ 221 V (220 Ω)
R275	7030003370	S.RESISTOR	ERJ3GEYJ 271 V (270 Ω)
R276	7030003440	S.RESISTOR	ERJ3GEYJ 102 V (1 kΩ)
R277	7030003230	S.RESISTOR	ERJ3GEYJ 180 V (18 Ω)
R278	7030003370	S.RESISTOR	ERJ3GEYJ 271 V (270 Ω)
R281	7030003320	S.RESISTOR	ERJ3GEYJ 101 V (100 Ω)
R282	7030003620	S.RESISTOR	ERJ3GEYJ 333 V (33 kΩ)
R301	7030007230	S.RESISTOR	ERA3YED 102V
R302	7030007230	S.RESISTOR	ERA3YED 102V
R303	7030007230	S.RESISTOR	ERA3YED 102V
R304	7030007230	S.RESISTOR	ERA3YED 102V
R305	7030007230	S.RESISTOR	ERA3YED 102V
R306	7030007230	S.RESISTOR	ERA3YED 102V
R307	7030007210	S.RESISTOR	ERA3YEB 102V
R308	7030007210	S.RESISTOR	ERA3YEB 102V
R309	7030007210	S.RESISTOR	ERA3YEB 102V
R310	7030007210	S.RESISTOR	ERA3YEB 102V
R311	7030007210	S.RESISTOR	ERA3YEB 102V
R312	7030007220	S.RESISTOR	ERA3YED 202V
R313	7030007220	S.RESISTOR	ERA3YED 202V
R314	7030007220	S.RESISTOR	ERA3YED 202V
R315	7030007220	S.RESISTOR	ERA3YED 202V
R316	7030007220	S.RESISTOR	ERA3YED 202V
R317	7030007220	S.RESISTOR	ERA3YED 202V
R318	7030007220	S.RESISTOR	ERA3YED 202V
R319	7030007220	S.RESISTOR	ERA3YED 202V
R320	7030007200	S.RESISTOR	ERA3YEB 202V
R321	7030007200	S.RESISTOR	ERA3YEB 202V
R322	7030007200	S.RESISTOR	ERA3YEB 202V
R323	7030007200	S.RESISTOR	ERA3YEB 202V
R324	7030007200	S.RESISTOR	ERA3YEB 202V
R325	7030003440	S.RESISTOR	ERJ3GEYJ 102 V (1 kΩ)
R326	7030003440	S.RESISTOR	ERJ3GEYJ 102 V (1 kΩ)
R327	7030003800	S.RESISTOR	ERJ3GEYJ 105 V (1 MΩ)
R330	7030003440	S.RESISTOR	ERJ3GEYJ 102 V (1 kΩ)
R331	7030003800	S.RESISTOR	ERJ3GEYJ 105 V (1 MΩ)
R332	7030003440	S.RESISTOR	ERJ3GEYJ 102 V (1 kΩ)
R333	7030003440	S.RESISTOR	ERJ3GEYJ 102 V (1 kΩ)
R334	7030003680	S.RESISTOR	ERJ3GEYJ 104 V (100 kΩ)
R335	7030003360	S.RESISTOR	ERJ3GEYJ 221 V (220 Ω)
R336	7030003440	S.RESISTOR	ERJ3GEYJ 102 V (1 kΩ)
R337	7030003440	S.RESISTOR	ERJ3GEYJ 102 V (1 kΩ)
R338	7030003340	S.RESISTOR	ERJ3GEYJ 151 V (150 Ω)
R339	7030003360	S.RESISTOR	ERJ3GEYJ 221 V (220 Ω)
R340	7030003360	S.RESISTOR	ERJ3GEYJ 221 V (220 Ω)
R341	7030003440	S.RESISTOR	ERJ3GEYJ 102 V (1 kΩ)
R361	7030003320	S.RESISTOR	ERJ3GEYJ 101 V (100 Ω)
R362	7030003550	S.RESISTOR	ERJ3GEYJ 822 V (8.2 kΩ)
R363	7030003550	S.RESISTOR	ERJ3GEYJ 822 V (8.2 kΩ)
R364	7030003340	S.RESISTOR	ERJ3GEYJ 151 V (150 Ω)
R365	7030003340	S.RESISTOR	ERJ3GEYJ 151 V (150 Ω)
R366	7030003440	S.RESISTOR	ERJ3GEYJ 102 V (1 kΩ)
R367	7030003320	S.RESISTOR	ERJ3GEYJ 101 V (100 Ω)
R368	7030003560	S.RESISTOR	ERJ3GEYJ 103 V (10 kΩ)
R369	7030003560	S.RESISTOR	ERJ3GEYJ 103 V (10 kΩ)
R370	7030003840	S.RESISTOR	ERJ3GEYJ 225 V (2.2 MΩ)
R381	7030003400	S.RESISTOR	ERJ3GEYJ 471 V (470 Ω)
R391	7030003360	S.RESISTOR	ERJ3GEYJ 221 V (220 Ω)
R392	7030003380	S.RESISTOR	ERJ3GEYJ 331 V (330 Ω)
R393	7030003440	S.RESISTOR	ERJ3GEYJ 102 V (1 kΩ)
R394	7030003620	S.RESISTOR	ERJ3GEYJ 333 V (33 kΩ)
R397	7030003340	S.RESISTOR	ERJ3GEYJ 151 V (150 Ω)
R425	7030003300	S.RESISTOR	ERJ3GEYJ 680 V (68 Ω)
R426	7030003340	S.RESISTOR	ERJ3GEYJ 151 V (150 Ω)

S.=Surface mount

[PLL UNIT]

REF NO.	ORDER NO.	DESCRIPTION
R427	7030003300	S.RESISTOR ERJ3GEYJ 680 V (68 Ω)
R474	7030003560	S.RESISTOR ERJ3GEYJ 103 V (10 kΩ)
R475	7030003290	S.RESISTOR ERJ3GEYJ 560 V (56 Ω)
R476	7030003370	S.RESISTOR ERJ3GEYJ 271 V (270 Ω)
R477	7030003230	S.RESISTOR ERJ3GEYJ 180 V (18 Ω)
R478	7030003370	S.RESISTOR ERJ3GEYJ 271 V (270 Ω)
R479	7030003370	S.RESISTOR ERJ3GEYJ 271 V (270 Ω)
R481	7030003320	S.RESISTOR ERJ3GEYJ 101 V (100 Ω)
R482	7030003620	S.RESISTOR ERJ3GEYJ 333 V (33 kΩ)
R483	7030003440	S.RESISTOR ERJ3GEYJ 102 V (1 kΩ)
R501	7030008190	S.RESISTOR ERJ12YJ330U (33 Ω)
R502	7030008190	S.RESISTOR ERJ12YJ330U (33 Ω)
R503	7030008190	S.RESISTOR ERJ12YJ330U (33 Ω)
R515	7030003420	S.RESISTOR ERJ3GEYJ 681 V (680 Ω)
R538	7030003470	S.RESISTOR ERJ3GEYJ 182 V (1.8 kΩ)
R541	7030003420	S.RESISTOR ERJ3GEYJ 681 V (680 Ω)
R542	7030003630	S.RESISTOR ERJ3GEYJ 393 V (39 kΩ)
R543	7030003320	S.RESISTOR ERJ3GEYJ 101 V (100 Ω)
R544	7030003400	S.RESISTOR ERJ3GEYJ 471 V (470 Ω)
R545	7030003270	S.RESISTOR ERJ3GEYJ 390 V (39 Ω)
R547	7030003330	S.RESISTOR ERJ3GEYJ 121 V (120 Ω)
R548	7030003330	S.RESISTOR ERJ3GEYJ 121 V (120 Ω)
R551	7030003460	S.RESISTOR ERJ3GEYJ 152 V (1.5 kΩ)
R552	7030003320	S.RESISTOR ERJ3GEYJ 101 V (100 Ω)
R553	7030003580	S.RESISTOR ERJ3GEYJ 153 V (15 kΩ)
R554	7030003530	S.RESISTOR ERJ3GEYJ 562 V (5.6 kΩ)
R555	7030003340	S.RESISTOR ERJ3GEYJ 151 V (150 Ω)
R556	7030003320	S.RESISTOR ERJ3GEYJ 101 V (100 Ω)
R557	7030003290	S.RESISTOR ERJ3GEYJ 560 V (56 Ω)
R558	7030003320	S.RESISTOR ERJ3GEYJ 101 V (100 Ω)
R559	7510001190	S.THERMISTOR NTCCM1608 4BH 472KC
R568	7030003640	S.RESISTOR ERJ3GEYJ 473 V (47 kΩ)
R569	7030003320	S.RESISTOR ERJ3GEYJ 101 V (100 Ω)
R570	7310002720	S.TRIMMER RV-148 (RH03A3AS3X0DA) 472
R571	7030003360	S.RESISTOR ERJ3GEYJ 221 V (220 Ω)
R572	7030003600	S.RESISTOR ERJ3GEYJ 223 V (22 kΩ)
R601	7030007230	S.RESISTOR ERA3YED 102V
R602	7030007230	S.RESISTOR ERA3YED 102V
R603	7030007230	S.RESISTOR ERA3YED 102V
R604	7030007230	S.RESISTOR ERA3YED 102V
R605	7030007230	S.RESISTOR ERA3YED 102V
R606	7030007230	S.RESISTOR ERA3YED 102V
R607	7030007210	S.RESISTOR ERA3YEB 102V
R608	7030007210	S.RESISTOR ERA3YEB 102V
R609	7030007210	S.RESISTOR ERA3YEB 102V
R610	7030007220	S.RESISTOR ERA3YED 202V
R611	7030007220	S.RESISTOR ERA3YED 202V
R612	7030007220	S.RESISTOR ERA3YED 202V
R613	7030007220	S.RESISTOR ERA3YED 202V
R614	7030007220	S.RESISTOR ERA3YED 202V
R615	7030007220	S.RESISTOR ERA3YED 202V
R616	7030007220	S.RESISTOR ERA3YED 202V
R617	7030007200	S.RESISTOR ERA3YEB 202V
R618	7030007200	S.RESISTOR ERA3YEB 202V
R619	7030007200	S.RESISTOR ERA3YEB 202V
R620	7030007200	S.RESISTOR ERA3YEB 202V
R621	7030003350	S.RESISTOR ERJ3GEYJ 181 V (180 Ω)
R622	7030003360	S.RESISTOR ERJ3GEYJ 221 V (220 Ω)
R623	7030003640	S.RESISTOR ERJ3GEYJ 473 V (47 kΩ)
R625	7030003370	S.RESISTOR ERJ3GEYJ 271 V (270 Ω)
R626	7030003230	S.RESISTOR ERJ3GEYJ 180 V (18 Ω)
R627	7030003370	S.RESISTOR ERJ3GEYJ 271 V (270 Ω)
R628	7030003440	S.RESISTOR ERJ3GEYJ 102 V (1 kΩ)
R629	7030003360	S.RESISTOR ERJ3GEYJ 221 V (220 Ω)
R630	7030003360	S.RESISTOR ERJ3GEYJ 221 V (220 Ω)
R631	7030003360	S.RESISTOR ERJ3GEYJ 221 V (220 Ω)
R701	7030007230	S.RESISTOR ERA3YED 102V
R702	7030007230	S.RESISTOR ERA3YED 102V
R703	7030007230	S.RESISTOR ERA3YED 102V
R704	7030007230	S.RESISTOR ERA3YED 102V
R705	7030007230	S.RESISTOR ERA3YED 102V
R706	7030007230	S.RESISTOR ERA3YED 102V
R707	7030007210	S.RESISTOR ERA3YEB 102V
R708	7030007210	S.RESISTOR ERA3YEB 102V
R709	7030007210	S.RESISTOR ERA3YEB 102V
R710	7030007220	S.RESISTOR ERA3YED 202V
R711	7030007220	S.RESISTOR ERA3YED 202V
R712	7030007220	S.RESISTOR ERA3YED 202V
R713	7030007220	S.RESISTOR ERA3YED 202V
R714	7030007220	S.RESISTOR ERA3YED 202V
R715	7030007220	S.RESISTOR ERA3YED 202V
R716	7030007220	S.RESISTOR ERA3YED 202V

[PLL UNIT]

REF NO.	ORDER NO.	DESCRIPTION
R717	7030007200	S.RESISTOR ERA3YEB 202V
R718	7030007200	S.RESISTOR ERA3YEB 202V
R719	7030007200	S.RESISTOR ERA3YEB 202V
R720	7030007200	S.RESISTOR ERA3YEB 202V
R721	7030003350	S.RESISTOR ERJ3GEYJ 181 V (180 Ω)
R722	7030003360	S.RESISTOR ERJ3GEYJ 221 V (220 Ω)
R723	7030003640	S.RESISTOR ERJ3GEYJ 473 V (47 kΩ)
R725	7030003370	S.RESISTOR ERJ3GEYJ 271 V (270 Ω)
R726	7030003230	S.RESISTOR ERJ3GEYJ 180 V (18 Ω)
R727	7030003370	S.RESISTOR ERJ3GEYJ 271 V (270 Ω)
R728	7030003440	S.RESISTOR ERJ3GEYJ 102 V (1 kΩ)
R729	7030003360	S.RESISTOR ERJ3GEYJ 221 V (220 Ω)
R730	7030003360	S.RESISTOR ERJ3GEYJ 221 V (220 Ω)
R731	7030003360	S.RESISTOR ERJ3GEYJ 221 V (220 Ω)
C1	4030006900	S.CERAMIC C1608 JB 1E 103K-T-A
C2	4030006860	S.CERAMIC C1608 JB 1H 102K-T-A
C3	4030006860	S.CERAMIC C1608 JB 1H 102K-T-A
C4	4030006860	S.CERAMIC C1608 JB 1H 102K-T-A
C5	4030006860	S.CERAMIC C1608 JB 1H 102K-T-A
C9	4030006860	S.CERAMIC C1608 JB 1H 102K-T-A
C12	4030006860	S.CERAMIC C1608 JB 1H 102K-T-A
C13	4030006860	S.CERAMIC C1608 JB 1H 102K-T-A
C14	4030006860	S.CERAMIC C1608 JB 1H 102K-T-A
C15	4030011600	S.CERAMIC C1608 JB 1C 104KT-N
C16	4030011600	S.CERAMIC C1608 JB 1C 104KT-N
C101	4030007010	S.CERAMIC C1608 CH 1H 100D-T-A
C102	4030007010	S.CERAMIC C1608 CH 1H 100D-T-A
C103	4030007080	S.CERAMIC C1608 CH 1H 390J-T-A
C104	4030007050	S.CERAMIC C1608 CH 1H 220J-T-A
C105	4030007100	S.CERAMIC C1608 CH 1H 560J-T-A
C106	4030007020	S.CERAMIC C1608 CH 1H 120J-T-A
C107	4030007110	S.CERAMIC C1608 CH 1H 680J-T-A
C108	4030006950	S.CERAMIC C1608 CH 1H 040C-T-A
C109	4030007100	S.CERAMIC C1608 CH 1H 560J-T-A
C110	4030007060	S.CERAMIC C1608 CH 1H 270J-T-A
C111	4030008920	S.CERAMIC C1608 JB 1C 473K-T-A
C113	4030008920	S.CERAMIC C1608 JB 1C 473K-T-A
C121	4030008920	S.CERAMIC C1608 JB 1C 473K-T-A
C122	4030012600	S.CERAMIC C2012 JB 1A 105M-T-A
C123	4030007110	S.CERAMIC C1608 CH 1H 680J-T-A
C124	4030007040	S.CERAMIC C1608 CH 1H 180J-T-A
C131	4030008920	S.CERAMIC C1608 JB 1C 473K-T-A
C132	4030008920	S.CERAMIC C1608 JB 1C 473K-T-A
C133	4030008920	S.CERAMIC C1608 JB 1C 473K-T-A
C134	4030008920	S.CERAMIC C1608 JB 1C 473K-T-A
C135	4030008920	S.CERAMIC C1608 JB 1C 473K-T-A
C136	4030008920	S.CERAMIC C1608 JB 1C 473K-T-A
C137	4030007110	S.CERAMIC C1608 CH 1H 680J-T-A
C138	4030008920	S.CERAMIC C1608 JB 1C 473K-T-A
C139	4030008920	S.CERAMIC C1608 JB 1C 473K-T-A
C140	4030007130	S.CERAMIC C1608 CH 1H 101J-T-A
C141	4030008920	S.CERAMIC C1608 JB 1C 473K-T-A
C142	4030008920	S.CERAMIC C1608 JB 1C 473K-T-A
C143	4030008920	S.CERAMIC C1608 JB 1C 473K-T-A
C144	4030008920	S.CERAMIC C1608 JB 1C 473K-T-A
C145	4030008920	S.CERAMIC C1608 JB 1C 473K-T-A
C146	4030008920	S.CERAMIC C1608 JB 1C 473K-T-A
C147	4550006700	S.TANTALUM ECST1AY106R
C148	4030006860	S.CERAMIC C1608 JB 1H 102K-T-A
C153	4030006900	S.CERAMIC C1608 JB 1E 103K-T-A
C161	4030006860	S.CERAMIC C1608 JB 1H 102K-T-A
C162	4030006850	S.CERAMIC C1608 JB 1H 471K-T-A
C163	4510004630	S.ELECTROLYTIC ECEV1CA100SR
C164	4550006170	S.TANTALUM ECST1AY225R
C165	4550006170	S.TANTALUM ECST1AY225R
C166	4550006150	S.TANTALUM ECST1CY105R
C167	4030006860	S.CERAMIC C1608 JB 1H 102K-T-A
C168	4030006850	S.CERAMIC C1608 JB 1H 471K-T-A
C169	4510004630	S.ELECTROLYTIC ECEV1CA100SR
C170	4030006860	S.CERAMIC C1608 JB 1H 102K-T-A
C171	4030008920	S.CERAMIC C1608 JB 1C 473K-T-A
C172	4030006860	S.CERAMIC C1608 JB 1H 102K-T-A
C173	4030006860	S.CERAMIC C1608 JB 1H 102K-T-A
C174	4030006860	S.CERAMIC C1608 JB 1H 102K-T-A
C175	4510004440	S.ELECTROLYTIC ECEV1HA010SR
C181	4510004630	S.ELECTROLYTIC ECEV1CA100SR
C182	4510004630	S.ELECTROLYTIC ECEV1CA100SR
C183	4030006860	S.CERAMIC C1608 JB 1H 102K-T-A
C184	4030006860	S.CERAMIC C1608 JB 1H 102K-T-A
C191	4030007070	S.CERAMIC C1608 CH 1H 330J-T-A

S.=Surface mount

[PLL UNIT]

REF NO.	ORDER NO.	DESCRIPTION
C192	4030006860	S.CERAMIC C1608 JB 1H 102K-T-A
C193	4030006860	S.CERAMIC C1608 JB 1H 102K-T-A
C194	4030006910	S.CERAMIC C1608 CH 1H 0R5C-T-A
C196	4030006860	S.CERAMIC C1608 JB 1H 102K-T-A
C198	4030007090	S.CERAMIC C1608 CH 1H 470J-T-A
C213	4030007060	S.CERAMIC C1608 CH 1H 270J-T-A
C214	4030009920	S.CERAMIC C1608 CH 1H 050B-T-A
C215	4030007070	S.CERAMIC C1608 CH 1H 330J-T-A
C216	4030009520	S.CERAMIC C1608 CH 1H 020B-T-A
C217	4030007040	S.CERAMIC C1608 CH 1H 180J-T-A
C229	4030006860	S.CERAMIC C1608 JB 1H 102K-T-A
C251	4030006860	S.CERAMIC C1608 JB 1H 102K-T-A
C253	4030007010	S.CERAMIC C1608 CH 1H 100D-T-A
C254	4030007010	S.CERAMIC C1608 CH 1H 100D-T-A
C261	4030006880	S.CERAMIC C1608 JB 1H 472K-T-A
C262	4030006880	S.CERAMIC C1608 JB 1H 472K-T-A
C263	4030006880	S.CERAMIC C1608 JB 1H 472K-T-A
C273	4030006860	S.CERAMIC C1608 JB 1H 102K-T-A
C274	4030011600	S.CERAMIC C1608 JB 1C 104KT-N
C275	4030006880	S.CERAMIC C1608 JB 1H 472K-T-A
C276	4030006860	S.CERAMIC C1608 JB 1H 102K-T-A
C277	4030006980	S.CERAMIC C1608 CH 1H 070D-T-A
C278	4030006860	S.CERAMIC C1608 JB 1H 102K-T-A
C279	4030006860	S.CERAMIC C1608 JB 1H 102K-T-A
C280	4030006860	S.CERAMIC C1608 JB 1H 102K-T-A
C281	4030007010	S.CERAMIC C1608 CH 1H 100D-T-A
C283	4030006860	S.CERAMIC C1608 JB 1H 102K-T-A
C284	4030007050	S.CERAMIC C1608 CH 1H 220J-T-A
C301	4030007010	S.CERAMIC C1608 CH 1H 100D-T-A
C302	4030007010	S.CERAMIC C1608 CH 1H 100D-T-A
C303	4030007010	S.CERAMIC C1608 CH 1H 100D-T-A
C304	4030007090	S.CERAMIC C1608 CH 1H 470J-T-A
C306	4030007120	S.CERAMIC C1608 CH 1H 820J-T-A
C308	4030007110	S.CERAMIC C1608 CH 1H 680J-T-A
C310	4030007100	S.CERAMIC C1608 CH 1H 560J-T-A
C312	4030008920	S.CERAMIC C1608 JB 1C 473K-T-A
C314	4030008920	S.CERAMIC C1608 JB 1C 473K-T-A
C321	4030008920	S.CERAMIC C1608 JB 1C 473K-T-A
C322	4030012600	S.CERAMIC C2012 JB 1A 105M-T-A
C323	4030007050	S.CERAMIC C1608 CH 1H 220J-T-A
C325	4030007020	S.CERAMIC C1608 CH 1H 120J-T-A
C327	4550006670	S.TANTALUM ECST1AD107R
C329	4550006670	S.TANTALUM ECST1AD107R
C330	4030007090	S.CERAMIC C1608 CH 1H 470J-T-A
C331	4030008920	S.CERAMIC C1608 JB 1C 473K-T-A
C332	4030008920	S.CERAMIC C1608 JB 1C 473K-T-A
C333	4030008920	S.CERAMIC C1608 JB 1C 473K-T-A
C334	4030008920	S.CERAMIC C1608 JB 1C 473K-T-A
C335	4030008920	S.CERAMIC C1608 JB 1C 473K-T-A
C336	4030008920	S.CERAMIC C1608 JB 1C 473K-T-A
C337	4030008920	S.CERAMIC C1608 JB 1C 473K-T-A
C339	4030008920	S.CERAMIC C1608 JB 1C 473K-T-A
C340	4030008920	S.CERAMIC C1608 JB 1C 473K-T-A
C341	4030008920	S.CERAMIC C1608 JB 1C 473K-T-A
C342	4030008920	S.CERAMIC C1608 JB 1C 473K-T-A
C343	4030008920	S.CERAMIC C1608 JB 1C 473K-T-A
C344	4030008920	S.CERAMIC C1608 JB 1C 473K-T-A
C345	4030008920	S.CERAMIC C1608 JB 1C 473K-T-A
C347	4550006700	S.TANTALUM ECST1AY106R
C348	4030006860	S.CERAMIC C1608 JB 1H 102K-T-A
C350	4030006900	S.CERAMIC C1608 JB 1E 103K-T-A
C362	4550006170	S.TANTALUM ECST1AY225R
C363	4550006170	S.TANTALUM ECST1AY225R
C364	4510004630	S.ELECTROLYTIC ECEV1CA100SR
C365	4030006850	S.CERAMIC C1608 JB 1H 471K-T-A
C366	4030006860	S.CERAMIC C1608 JB 1H 102K-T-A
C368	4550006150	S.TANTALUM ECST1CY105R
C369	4510004630	S.ELECTROLYTIC ECEV1CA100SR
C370	4030006850	S.CERAMIC C1608 JB 1H 471K-T-A
C371	4030006860	S.CERAMIC C1608 JB 1H 102K-T-A
C372	4030007130	S.CERAMIC C1608 CH 1H 101J-T-A
C373	4030006850	S.CERAMIC C1608 JB 1H 471K-T-A
C374	4030006850	S.CERAMIC C1608 JB 1H 471K-T-A
C375	4030006860	S.CERAMIC C1608 JB 1H 102K-T-A
C376	4030006860	S.CERAMIC C1608 JB 1H 102K-T-A
C377	4510004440	S.ELECTROLYTIC ECEV1HA010SR
C381	4510005370	S.ELECTROLYTIC ECEV1AA221P
C382	4030006860	S.CERAMIC C1608 JB 1H 102K-T-A
C383	4030006860	S.CERAMIC C1608 JB 1H 102K-T-A
C391	4030006850	S.CERAMIC C1608 JB 1H 471K-T-A
C392	4030008920	S.CERAMIC C1608 JB 1C 473K-T-A
C393	4030006860	S.CERAMIC C1608 JB 1H 102K-T-A

[PLL UNIT]

REF NO.	ORDER NO.	DESCRIPTION
C394	4030006850	S.CERAMIC C1608 JB 1H 471K-T-A
C398	4030006860	S.CERAMIC C1608 JB 1H 102K-T-A
C399	4030006860	S.CERAMIC C1608 JB 1H 102K-T-A
C401	4030011340	S.CERAMIC C1608 CH 1H 471J-T-A
C402	4610001920	S.TRIMMER TZO3Z0260A110 6P
C403	4030006950	S.CERAMIC C1608 CH 1H 040C-T-A
C404	4030006950	S.CERAMIC C1608 CH 1H 040C-T-A
C405	4030009500	S.CERAMIC C1608 CH 1H 0R5B-T-A
C407	4030006860	S.CERAMIC C1608 JB 1H 102K-T-A
C408	4030006860	S.CERAMIC C1608 JB 1H 102K-T-A
C410	4030011340	S.CERAMIC C1608 CH 1H 471J-T-A
C413	4030006960	S.CERAMIC C1608 CH 1H 050C-T-A
C421	4030006980	S.CERAMIC C1608 CH 1H 070D-T-A
C422	4030006930	S.CERAMIC C1608 CH 1H 020C-T-A
C423	4030006980	S.CERAMIC C1608 CH 1H 070D-T-A
C426	4030006960	S.CERAMIC C1608 CH 1H 050C-T-A
C428	4030006980	S.CERAMIC C1608 CH 1H 070D-T-A
C430	4030006960	S.CERAMIC C1608 CH 1H 050C-T-A
C471	4030008920	S.CERAMIC C1608 JB 1C 473K-T-A
C472	4030012600	S.CERAMIC C2012 JB 1A 105M-T-A
C474	4030007090	S.CERAMIC C1608 CH 1H 470J-T-A
C475	4030006860	S.CERAMIC C1608 JB 1H 102K-T-A
C476	4030006860	S.CERAMIC C1608 JB 1H 102K-T-A
C478	4030011600	S.CERAMIC C1608 JB 1C 104KT-N
C480	4030006860	S.CERAMIC C1608 JB 1H 102K-T-A
C481	4030006860	S.CERAMIC C1608 JB 1H 102K-T-A
C482	4030006860	S.CERAMIC C1608 JB 1H 102K-T-A
C483	4030006860	S.CERAMIC C1608 JB 1H 102K-T-A
C484	4030006860	S.CERAMIC C1608 JB 1H 102K-T-A
C485	4030006920	S.CERAMIC C1608 CH 1H 010C-T-A
C487	4030006860	S.CERAMIC C1608 JB 1H 102K-T-A
C488	4030006860	S.CERAMIC C1608 JB 1H 102K-T-A
C501	4030008920	S.CERAMIC C1608 JB 1C 473K-T-A
C502	4510004630	S.ELECTROLYTIC ECEV1CA100SR
C503	4510004630	S.ELECTROLYTIC ECEV1CA100SR
C504	4030008920	S.CERAMIC C1608 JB 1C 473K-T-A
C505	4030006860	S.CERAMIC C1608 JB 1H 102K-T-A
C511	4030006880	S.CERAMIC C1608 JB 1H 472K-T-A
C512	4510006220	S.ELECTROLYTIC ECEV1CA101UP
C513	4030006860	S.CERAMIC C1608 JB 1H 102K-T-A
C514	4030006880	S.CERAMIC C1608 JB 1H 472K-T-A
C515	4030006980	S.CERAMIC C1608 CH 1H 070D-T-A
C535	4030006880	S.CERAMIC C1608 JB 1H 472K-T-A
C541	4030006860	S.CERAMIC C1608 JB 1H 102K-T-A
C542	4030006860	S.CERAMIC C1608 JB 1H 102K-T-A
C543	4030006880	S.CERAMIC C1608 JB 1H 472K-T-A
C544	4030007030	S.CERAMIC C1608 CH 1H 150J-T-A
C545	4030006860	S.CERAMIC C1608 JB 1H 102K-T-A
C551	4030006860	S.CERAMIC C1608 JB 1H 102K-T-A
C552	4030006880	S.CERAMIC C1608 JB 1H 472K-T-A
C553	4030006860	S.CERAMIC C1608 JB 1H 102K-T-A
C554	4030007050	S.CERAMIC C1608 CH 1H 220J-T-A
C555	4030006880	S.CERAMIC C1608 JB 1H 472K-T-A
C556	4030006920	S.CERAMIC C1608 CH 1H 010C-T-A
C557	4030007050	S.CERAMIC C1608 CH 1H 220J-T-A
C558	4030006860	S.CERAMIC C1608 JB 1H 102K-T-A
C559	4030007110	S.CERAMIC C1608 CH 1H 680J-T-A
C560	4030007110	S.CERAMIC C1608 CH 1H 680J-T-A
C574	4030006880	S.CERAMIC C1608 JB 1H 472K-T-A
C575	4030011600	S.CERAMIC C1608 JB 1C 104KT-N
C601	4030007170	S.CERAMIC C1608 CH 1H 221J-T-A
C602	4030007100	S.CERAMIC C1608 CH 1H 560J-T-A
C603	4030011330	S.CERAMIC C1608 CH 1H 391J-T-A
C604	4030007160	S.CERAMIC C1608 CH 1H 181J-T-A
C605	4030007160	S.CERAMIC C1608 CH 1H 181J-T-A
C608	4030007110	S.CERAMIC C1608 CH 1H 680J-T-A
C609	4030006900	S.CERAMIC C1608 JB 1E 103K-T-A
C610	4030006900	S.CERAMIC C1608 JB 1E 103K-T-A
C611	4030006900	S.CERAMIC C1608 JB 1E 103K-T-A
C613	4030006880	S.CERAMIC C1608 JB 1H 472K-T-A
C614	4030006900	S.CERAMIC C1608 JB 1E 103K-T-A
C615	4030006900	S.CERAMIC C1608 JB 1E 103K-T-A
C616	4030006900	S.CERAMIC C1608 JB 1E 103K-T-A
C617	4030006900	S.CERAMIC C1608 JB 1E 103K-T-A
C618	4030011600	S.CERAMIC C1608 JB 1C 104KT-N
C619	4550006700	S.TANTALUM ECST1AY106R
C620	4030007130	S.CERAMIC C1608 CH 1H 101J-T-A
C621	4030007130	S.CERAMIC C1608 CH 1H 101J-T-A
C701	4030007170	S.CERAMIC C1608 CH 1H 221J-T-A
C702	4030007100	S.CERAMIC C1608 CH 1H 560J-T-A
C703	4030011330	S.CERAMIC C1608 CH 1H 391J-T-A
C704	4030007160	S.CERAMIC C1608 CH 1H 181J-T-A

S.=Surface mount

[PLL UNIT]

REF NO.	ORDER NO.	DESCRIPTION	
C705	4030007160	S.CERAMIC	C1608 CH 1H 181J-T-A
C708	4030007110	S.CERAMIC	C1608 CH 1H 680J-T-A
C709	4030006900	S.CERAMIC	C1608 JB 1E 103K-T-A
C710	4030006900	S.CERAMIC	C1608 JB 1E 103K-T-A
C711	4030006900	S.CERAMIC	C1608 JB 1E 103K-T-A
C713	4030006880	S.CERAMIC	C1608 JB 1H 472K-T-A
C714	4030006900	S.CERAMIC	C1608 JB 1E 103K-T-A
C715	4030006900	S.CERAMIC	C1608 JB 1E 103K-T-A
C716	4030006900	S.CERAMIC	C1608 JB 1E 103K-T-A
C717	4030006900	S.CERAMIC	C1608 JB 1E 103K-T-A
C718	4030011600	S.CERAMIC	C1608 JB 1C 104KT-N
C719	4550006700	S.TANTALUM	ECST1AY106R
C720	4030007130	S.CERAMIC	C1608 CH 1H 101J-T-A
C721	4030007130	S.CERAMIC	C1608 CH 1H 101J-T-A
J1	6510022540	S.CONNECTOR	20FMN-BMTTR-A-TBT
J541	6510007020	CONNECTOR	TMP-J01X-V6
W603	7030003860	S.JUMPER	ERJ3GE JPW V
W703	7030003860	S.JUMPER	ERJ3GE JPW V
WS1	8970023740	E.OTHER	SX2355 1.5D COAXIAL TUBE (1)/PL
WS2	8970023750	E.OTHER	SX2355 1.5D COAXIAL TUBE (1)/PL
WS3	8970023760	E.OTHER	SX2355 0.8D COAXIAL TUBE (1)/PL
WS4	8970023770	E.OTHER	SX2355 0.8D COAXIAL TUBE (2)/PL
EP1	0910052695	PCB	B 5464E

[MAIN UNIT]

REF NO.	ORDER NO.	DESCRIPTION	
IC101	1110003140	IC	LA1150N
IC201	1110004840	S.IC	NJM1496V-TE1
IC351	1110004870	S.IC	TA4101F (TE12L)
IC401	1110003490	S.IC	TA31136FN (D,EL)
IC451	1110003870	S.IC	NJM2058M-T1
IC452	1130008230	S.IC	BU4053BCFV-E2
IC701	1110003140	IC	LA1150N
IC801	1180002040	REG	BA09T
IC803	1110002020	IC	TA7805S
IC851	1110004870	S.IC	TA4101F (TE12L)
IC951	1110003490	S.IC	TA31136FN (D,EL)
IC1001	1110003870	S.IC	NJM2058M-T1
IC1002	1130008230	S.IC	BU4053BCFV-E2
IC1101	1130007040	S.IC	TC7W32F (TE12L)
IC1451	1130007570	S.IC	BU4094BCFV-E2
IC1461	1130007570	S.IC	BU4094BCFV-E2
IC1471	1130007570	S.IC	BU4094BCFV-E2
IC1481	1130007570	S.IC	BU4094BCFV-E2
IC1491	1130007570	S.IC	BU4094BCFV-E2
IC1511	1130007570	S.IC	BU4094BCFV-E2
IC1521	1110004310	S.IC	M62352GP 75EC
IC1522	1110003870	S.IC	NJM2058M-T1
IC1531	1130008230	S.IC	BU4053BCFV-E2
IC1551	1130008230	S.IC	BU4053BCFV-E2
IC1552	1130008230	S.IC	BU4053BCFV-E2
IC1601	1110003870	S.IC	NJM2058M-T1
IC1651	1110005240	S.IC	NJM4565M-T1
IC1652	1110003870	S.IC	NJM2058M-T1
IC1653	1130008230	S.IC	BU4053BCFV-E2
IC1654	1110005240	S.IC	NJM4565M-T1
IC1701	1140005280	S.IC	μPC5023GS-077-E1
IC1801	1130008230	S.IC	BU4053BCFV-E2
IC1802	1130008230	S.IC	BU4053BCFV-E2
IC1803	1190000350	S.IC	M62363FP-650C
IC1804	1110003870	S.IC	NJM2058M-T1
IC1806	1130008230	S.IC	BU4053BCFV-E2
IC1807	1110003870	S.IC	NJM2058M-T1
IC1808	1110003300	S.IC	M5282FP 70CD
IC1809	1110003300	S.IC	M5282FP 70CD
IC1852	1110002540	IC	LA4445
Q1	1580000540	S.FET	3SK131-T2-LA
Q21	1590000430	S.TRANSISTOR	DTC144EUA T106
Q22	1590000680	S.TRANSISTOR	DTC114EUA T106
Q51	1580000540	S.FET	3SK131-T2-LA
Q52	1530002690	S.TRANSISTOR	2SC4116-GR (TE85R)
Q101	1560000560	S.FET	2SK882-GR (TE85L)
Q102	1560000560	S.FET	2SK882-GR (TE85L)
Q103	1590001650	S.TRANSISTOR	XP4601 (TX)
Q105	1530002690	S.TRANSISTOR	2SC4116-GR (TE85R)
Q106	1590000430	S.TRANSISTOR	DTC144EUA T106
Q107	1590001660	S.TRANSISTOR	XP4312 (TX)
Q151	1590001660	S.TRANSISTOR	XP4312 (TX)
Q152	1590001660	S.TRANSISTOR	XP4312 (TX)
Q153	1590001660	S.TRANSISTOR	XP4312 (TX)
Q201	1590000430	S.TRANSISTOR	DTC144EUA T106
Q251	1590001660	S.TRANSISTOR	XP4312 (TX)
Q252	1510000770	S.TRANSISTOR	2SA1586-GR (TE85R)
Q253	1590000670	S.TRANSISTOR	FMW1 T148
Q254	1530002690	S.TRANSISTOR	2SC4116-GR (TE85R)
Q271	1590001650	S.TRANSISTOR	XP4601 (TX)
Q301	1530002690	S.TRANSISTOR	2SC4116-GR (TE85R)
Q302	1590001660	S.TRANSISTOR	XP4312 (TX)
Q303	1590001660	S.TRANSISTOR	XP4312 (TX)
Q304	1590001660	S.TRANSISTOR	XP4312 (TX)
Q305	1530002690	S.TRANSISTOR	2SC4116-GR (TE85R)
Q350	1530002690	S.TRANSISTOR	2SC4116-GR (TE85R)
Q351	1580000540	S.FET	3SK131-T2-LA
Q352	1580000540	S.FET	3SK131-T2-LA
Q402	1590001660	S.TRANSISTOR	XP4312 (TX)
Q404	1560000840	S.FET	2SK1829 (TE85R)
Q405	1590001650	S.TRANSISTOR	XP4601 (TX)
Q406	1560000840	S.FET	2SK1829 (TE85R)
Q407	1550000010	S.FET	2SJ364-Q (TX)
Q651	1580000540	S.FET	3SK131-T2-LA
Q652	1530002690	S.TRANSISTOR	2SC4116-GR (TE85R)
Q701	1560000560	S.FET	2SK882-GR (TE85L)
Q702	1560000560	S.FET	2SK882-GR (TE85L)
Q703	1590001650	S.TRANSISTOR	XP4601 (TX)
Q705	1530002690	S.TRANSISTOR	2SC4116-GR (TE85R)
Q706	1590000430	S.TRANSISTOR	DTC144EUA T106

S.=Surface mount

[MAIN UNIT]

REF NO.	ORDER NO.	DESCRIPTION	
Q707	1590001660	S.TRANSISTOR	XP4312 (TX)
Q751	1590001660	S.TRANSISTOR	XP4312 (TX)
Q752	1590001660	S.TRANSISTOR	XP4312 (TX)
Q753	1590001660	S.TRANSISTOR	XP4312 (TX)
Q801	1540000550	S.TRANSISTOR	2SD1664 T100Q
Q804	1540000470	S.TRANSISTOR	2SD1801S-TL
Q805	1590001660	S.TRANSISTOR	XP4312 (TX)
Q806	1590000430	S.TRANSISTOR	DTC144EUA T106
Q807	1510000770	S.TRANSISTOR	2SA1586-GR (TE85R)
Q808	1590000430	S.TRANSISTOR	DTC144EUA T106
Q809	1590001660	S.TRANSISTOR	XP4312 (TX)
Q810	1510000770	S.TRANSISTOR	2SA1586-GR (TE85R)
Q811	1510000670	S.TRANSISTOR	2SA1588-GR (TE85R)
Q812	1590000430	S.TRANSISTOR	DTC144EUA T106
Q813	1510000670	S.TRANSISTOR	2SA1588-GR (TE85R)
Q814	1590000430	S.TRANSISTOR	DTC144EUA T106
Q815	1510000670	S.TRANSISTOR	2SA1588-GR (TE85R)
Q816	1530002690	S.TRANSISTOR	2SC4116-GR (TE85R)
Q817	1530002690	S.TRANSISTOR	2SC4116-GR (TE85R)
Q831	1590000430	S.TRANSISTOR	DTC144EUA T106
Q850	1530002690	S.TRANSISTOR	2SC4116-GR (TE85R)
Q851	1580000540	S.FET	3SK131-T2-LA
Q852	1580000540	S.FET	3SK131-T2-LA
Q901	1530002690	S.TRANSISTOR	2SC4116-GR (TE85R)
Q902	1530002690	S.TRANSISTOR	2SC4116-GR (TE85R)
Q903	1590001660	S.TRANSISTOR	XP4312 (TX)
Q904	1590001660	S.TRANSISTOR	XP4312 (TX)
Q905	1590001660	S.TRANSISTOR	XP4312 (TX)
Q951	1590001660	S.TRANSISTOR	XP4312 (TX)
Q952	1560000840	S.FET	2SK1829 (TE85R)
Q953	1590001650	S.TRANSISTOR	XP4601 (TX)
Q1001	1560000840	S.FET	2SK1829 (TE85R)
Q1002	1550000010	S.FET	2SJ364-Q (TX)
Q1561	1590001660	S.TRANSISTOR	XP4312 (TX)
Q1571	1590001660	S.TRANSISTOR	XP4312 (TX)
Q1581	1590000430	S.TRANSISTOR	DTC144EUA T106
Q1582	1540000440	S.TRANSISTOR	2SD1619-T-TD
Q1583	1590000680	S.TRANSISTOR	DTC114EUA T106
Q1584	1590001330	S.TRANSISTOR	DTA114EUA T106
Q1651	1530002690	S.TRANSISTOR	2SC4116-GR (TE85R)
Q1855	1590000680	S.TRANSISTOR	DTC114EUA T106
D1	1790000620	S.DIODE	MA77 (TX)
D2	1790000620	S.DIODE	MA77 (TX)
D21	1750000550	S.DIODE	1SS355 TE-17
D51	1790000620	S.DIODE	MA77 (TX)
D52	1790000620	S.DIODE	MA77 (TX)
D53	1790000620	S.DIODE	MA77 (TX)
D54	1790000620	S.DIODE	MA77 (TX)
D55	1790000620	S.DIODE	MA77 (TX)
D101	1790001210	S.DIODE	1SS375-TL
D151	1790000620	S.DIODE	MA77 (TX)
D152	1790000620	S.DIODE	MA77 (TX)
D153	1790000620	S.DIODE	MA77 (TX)
D154	1790000620	S.DIODE	MA77 (TX)
D155	1790000620	S.DIODE	MA77 (TX)
D156	1790000620	S.DIODE	MA77 (TX)
D157	1790000620	S.DIODE	MA77 (TX)
D158	1790000620	S.DIODE	MA77 (TX)
D159	1790000620	S.DIODE	MA77 (TX)
D161	1790000620	S.DIODE	MA77 (TX)
D162	1790000620	S.DIODE	MA77 (TX)
D201	1750000550	S.DIODE	1SS355 TE-17
D202	1790000620	S.DIODE	MA77 (TX)
D203	1790000620	S.DIODE	MA77 (TX)
D204	1750000550	S.DIODE	1SS355 TE-17
D205	1750000520	S.DIODE	DAN222TL
D206	1750000520	S.DIODE	DAN222TL
D207	1750000550	S.DIODE	1SS355 TE-17
D252	1790000620	S.DIODE	MA77 (TX)
D253	1720000270	S.VARICAP	1SV217 (TPH2)
D302	1790000660	S.DIODE	MA728 (TX)
D303	1790001210	S.DIODE	1SS375-TL
D304	1790000660	S.DIODE	MA728 (TX)
D305	1790000660	S.DIODE	MA728 (TX)
D352	1790000620	S.DIODE	MA77 (TX)
D401	1750000520	S.DIODE	DAN222TL
D402	1750000520	S.DIODE	DAN222TL
D491	1750000550	S.DIODE	1SS355 TE-17
D651	1790000620	S.DIODE	MA77 (TX)
D652	1790000620	S.DIODE	MA77 (TX)

[MAIN UNIT]

REF NO.	ORDER NO.	DESCRIPTION	
D653	1790000620	S.DIODE	MA77 (TX)
D701	1790001210	S.DIODE	1SS375-TL
D751	1790000620	S.DIODE	MA77 (TX)
D752	1790000620	S.DIODE	MA77 (TX)
D753	1790000620	S.DIODE	MA77 (TX)
D754	1790000620	S.DIODE	MA77 (TX)
D755	1790000620	S.DIODE	MA77 (TX)
D756	1790000620	S.DIODE	MA77 (TX)
D757	1790000620	S.DIODE	MA77 (TX)
D758	1790000620	S.DIODE	MA77 (TX)
D759	1790000620	S.DIODE	MA77 (TX)
D761	1790000620	S.DIODE	MA77 (TX)
D762	1790000620	S.DIODE	MA77 (TX)
D804	1750000370	S.DIODE	DA221 TL
D805	1750000550	S.DIODE	1SS355 TE-17
D806	1160000140	S.DIODE	DAP222 TL
D807	1750000370	S.DIODE	DA221 TL
D902	1790001210	S.DIODE	1SS375-TL
D903	1790000660	S.DIODE	MA728 (TX)
D904	1790000660	S.DIODE	MA728 (TX)
D905	1790000660	S.DIODE	MA728 (TX)
D951	1750000520	S.DIODE	DAN222TL
D952	1750000520	S.DIODE	DAN222TL
D1041	1750000550	S.DIODE	1SS355 TE-17
D1301	1750000520	S.DIODE	DAN222TL
D1351	1750000520	S.DIODE	DAN222TL
D1601	1750000550	S.DIODE	1SS355 TE-17
D1602	1160000140	S.DIODE	DAP222 TL
D1603	1750000550	S.DIODE	1SS355 TE-17
D1605	1750000550	S.DIODE	1SS355 TE-17
D1606	1790001010	S.ZENER	MA8043-L (TX)
D1607	1730002580	S.ZENER	MA8047-H (TX)
D1608	1750000370	S.DIODE	DA221 TL
D1609	1790000620	S.DIODE	MA77 (TX)
D1610	1750000550	S.DIODE	1SS355 TE-17
D1652	1790000660	S.DIODE	MA728 (TX)
D1701	1790001210	S.DIODE	1SS375-TL
D1801	1750000550	S.DIODE	1SS355 TE-17
D1802	1750000550	S.DIODE	1SS355 TE-17
D1821	1790000660	S.DIODE	MA728 (TX)
D1822	1790000660	S.DIODE	MA728 (TX)
D1851	1750000550	S.DIODE	1SS355 TE-17
FI51	2010001730	FILTER	FL-211 (10.850 MHz)
FI151	2010001080	FILTER	FL-128 (10M22D6)
FI311	2020001330	CERAMIC	CFWS455HT
FI312	2020001040	CERAMIC	CFWS455E
FI511	2020001330	CERAMIC	CFWS455HT
FI512	2020001040	CERAMIC	CFWS455E
FI651	2010001740	FILTER	FL-212 (10.950 MHz)
FI751	2010001090	FILTER	FL-129 (10M22D7)
X251	6050008700	XTAL	CR-451 (10.8550 MHz)
X401	6070000130	DISCRIMINATOR	CDBM455C24
X951	6070000130	DISCRIMINATOR	CDBM455C24
L1	6200002040	S.COIL	NL 252018T-101J
L2	6150004200	COIL	LS-479
L3	6150004170	COIL	LS-476
L51	6150004210	COIL	LS-480
L52	6150004210	COIL	LS-480
L53	6150004170	COIL	LS-476
L102	6150004880	S.COIL	LS-513
L103	6150004880	S.COIL	LS-513
L201	6200002040	S.COIL	NL 252018T-101J
L202	6200005040	S.COIL	NL 252018T-220J
L203	6200005040	S.COIL	NL 252018T-220J
L204	6200002040	S.COIL	NL 252018T-101J
L251	6200002040	S.COIL	NL 252018T-101J
L252	6200005010	S.COIL	NL 252018T-100J
L253	6200005010	S.COIL	NL 252018T-100J
L254	6200003130	S.COIL	NL 322522T-120J
L255	6150002040	COIL	LS-256
L352	6150004200	COIL	LS-479
L353	6150004210	COIL	LS-480
L354	6150004170	COIL	LS-476
L355	6200002040	S.COIL	NL 252018T-101J
L401	6200002040	S.COIL	NL 252018T-101J
L651	6150004210	COIL	LS-480

S.=Surface mount

[MAIN UNIT]

REF NO.	ORDER NO.	DESCRIPTION
C1667	4030011600	S.CERAMIC C1608 JB 1C 104KT-N
C1668	4030011600	S.CERAMIC C1608 JB 1C 104KT-N
C1669	4510004440	S.ELECTROLYTIC ECEV1HA010SR
C1670	4030011600	S.CERAMIC C1608 JB 1C 104KT-N
C1671	4510004630	S.ELECTROLYTIC ECEV1CA100SR
C1672	4030011600	S.CERAMIC C1608 JB 1C 104KT-N
C1674	4030011600	S.CERAMIC C1608 JB 1C 104KT-N
C1675	4030006900	S.CERAMIC C1608 JB 1E 103K-T-A
C1676	4030006900	S.CERAMIC C1608 JB 1E 103K-T-A
C1677	4510004440	S.ELECTROLYTIC ECEV1HA010SR
C1678	4030007140	S.CERAMIC C1608 CH 1H 121J-T-A
C1680	4030011600	S.CERAMIC C1608 JB 1C 104KT-N
C1701	4030011600	S.CERAMIC C1608 JB 1C 104KT-N
C1702	4030011600	S.CERAMIC C1608 JB 1C 104KT-N
C1703	4510004440	S.ELECTROLYTIC ECEV1HA010SR
C1704	4510004440	S.ELECTROLYTIC ECEV1HA010SR
C1705	4030011600	S.CERAMIC C1608 JB 1C 104KT-N
C1706	4510004440	S.ELECTROLYTIC ECEV1HA010SR
C1707	4510004440	S.ELECTROLYTIC ECEV1HA010SR
C1708	4030011600	S.CERAMIC C1608 JB 1C 104KT-N
C1709	4030008910	S.CERAMIC C1608 JB 1C 393K-T-A
C1710	4030011600	S.CERAMIC C1608 JB 1C 104KT-N
C1711	4030011600	S.CERAMIC C1608 JB 1C 104KT-N
C1712	4510004440	S.ELECTROLYTIC ECEV1HA010SR
C1713	4030007130	S.CERAMIC C1608 CH 1H 101J-T-A
C1714	4030011600	S.CERAMIC C1608 JB 1C 104KT-N
C1715	4030006850	S.CERAMIC C1608 JB 1H 471K-T-A
C1716	4030006850	S.CERAMIC C1608 JB 1H 471K-T-A
C1717	4030008920	S.CERAMIC C1608 JB 1C 473K-T-A
C1718	4510004630	S.ELECTROLYTIC ECEV1CA100SR
C1719	4030011600	S.CERAMIC C1608 JB 1C 104KT-N
C1720	4510005310	S.ELECTROLYTIC ECEV1CA220SR
C1721	4510005860	S.ELECTROLYTIC ECEV1HA2R2SR
C1722	4510004440	S.ELECTROLYTIC ECEV1HA010SR
C1723	4030011600	S.CERAMIC C1608 JB 1C 104KT-N
C1724	4030011600	S.CERAMIC C1608 JB 1C 104KT-N
C1771	4030011600	S.CERAMIC C1608 JB 1C 104KT-N
C1781	4030011600	S.CERAMIC C1608 JB 1C 104KT-N
C1801	4030006880	S.CERAMIC C1608 JB 1H 472K-T-A
C1802	4030006900	S.CERAMIC C1608 JB 1E 103K-T-A
C1803	4030011600	S.CERAMIC C1608 JB 1C 104KT-N
C1804	4030011600	S.CERAMIC C1608 JB 1C 104KT-N
C1807	4030011600	S.CERAMIC C1608 JB 1C 104KT-N
C1808	4030011600	S.CERAMIC C1608 JB 1C 104KT-N
C1809	4030011600	S.CERAMIC C1608 JB 1C 104KT-N
C1810	4030011600	S.CERAMIC C1608 JB 1C 104KT-N
C1811	4030007170	S.CERAMIC C1608 CH 1H 221J-T-A
C1812	4510004630	S.ELECTROLYTIC ECEV1CA100SR
C1813	4510004630	S.ELECTROLYTIC ECEV1CA100SR
C1814	4030007170	S.CERAMIC C1608 CH 1H 221J-T-A
C1821	4510005960	ELECTROLYTIC 10 MV 220 HC
C1822	4030011600	S.CERAMIC C1608 JB 1C 104KT-N
C1823	4510004630	S.ELECTROLYTIC ECEV1CA100SR
C1825	4030011600	S.CERAMIC C1608 JB 1C 104KT-N
C1827	4030011600	S.CERAMIC C1608 JB 1C 104KT-N
C1828	4030009630	S.CERAMIC C1608 JB 1H 822K-T-A
C1829	4030014300	S.CERAMIC C1608 JB 1C 563K-T-A
C1830	4030007170	S.CERAMIC C1608 CH 1H 221J-T-A
C1831	4510004440	S.ELECTROLYTIC ECEV1HA010SR
C1832	4510004630	S.ELECTROLYTIC ECEV1CA100SR
C1833	4510004630	S.ELECTROLYTIC ECEV1CA100SR
C1836	4030011600	S.CERAMIC C1608 JB 1C 104KT-N
C1837	4510005960	ELECTROLYTIC 10 MV 220 HC
C1838	4510004630	S.ELECTROLYTIC ECEV1CA100SR
C1839	4510004440	S.ELECTROLYTIC ECEV1HA010SR
C1840	4030011600	S.CERAMIC C1608 JB 1C 104KT-N
C1841	4030006870	S.CERAMIC C1608 JB 1H 222K-T-A
C1842	4510004440	S.ELECTROLYTIC ECEV1HA010SR
C1843	4030011600	S.CERAMIC C1608 JB 1C 104KT-N
C1844	4510004630	S.ELECTROLYTIC ECEV1CA100SR
C1845	4510005960	ELECTROLYTIC 10 MV 220 HC
C1846	4510004630	S.ELECTROLYTIC ECEV1CA100SR
C1847	4510004440	S.ELECTROLYTIC ECEV1HA010SR
C1848	4030011600	S.CERAMIC C1608 JB 1C 104KT-N
C1849	4030006870	S.CERAMIC C1608 JB 1H 222K-T-A
C1850	4510004440	S.ELECTROLYTIC ECEV1HA010SR
C1851	4030011600	S.CERAMIC C1608 JB 1C 104KT-N
C1852	4510004630	S.ELECTROLYTIC ECEV1CA100SR
C1855	4510003190	ELECTROLYTIC 6.3 RC2 47UF (D=4.0)
C1856	4510004590	ELECTROLYTIC 16 MV 470 HC
C1858	4510003190	ELECTROLYTIC 6.3 RC2 47UF (D=4.0)
C1859	4510004990	ELECTROLYTIC 16 MV 100 HC

[MAIN UNIT]

REF NO.	ORDER NO.	DESCRIPTION
C1860	4510004990	ELECTROLYTIC 16 MV 100 HC
C1861	4510004590	ELECTROLYTIC 16 MV 470 HC
C1862	4510004590	ELECTROLYTIC 16 MV 470 HC
C1863	4030011600	S.CERAMIC C1608 JB 1C 104KT-N
C1864	4030011600	S.CERAMIC C1608 JB 1C 104KT-N
C1865	4030006880	S.CERAMIC C1608 JB 1H 472K-T-A
C1867	4030006900	S.CERAMIC C1608 JB 1E 103K-T-A
C1870	4510004600	ELECTROLYTIC 16 MV 1000 HC
C1871	4030011600	S.CERAMIC C1608 JB 1C 104KT-N
C1872	4030006900	S.CERAMIC C1608 JB 1E 103K-T-A
C1873	4030006880	S.CERAMIC C1608 JB 1H 472K-T-A
C1874	4030006880	S.CERAMIC C1608 JB 1H 472K-T-A
C1876	4030006860	S.CERAMIC C1608 JB 1H 102K-T-A
C1877	4030011600	S.CERAMIC C1608 JB 1C 104KT-N
C1878	4030011600	S.CERAMIC C1608 JB 1C 104KT-N
C1879	4030006860	S.CERAMIC C1608 JB 1H 102K-T-A
C1880	4030006900	S.CERAMIC C1608 JB 1E 103K-T-A
C1881	4510004990	ELECTROLYTIC 16 MV 100 HC
RL1851	6330001640	RELAY ATX209
CP853	6910009670	S.CHECK P HK3-S-T
CP854	6910009670	S.CHECK P HK3-S-T
J2	6510022550	CONNECTOR 25FMN-BTK-A
J51	6510006360	CONNECTOR TMP-J02X-A1
J52	6510006360	CONNECTOR TMP-J02X-A1
J501	6510018960	S.CONNECTOR B2B-PH-SM3-TB
J651	6510006360	CONNECTOR TMP-J02X-A1
J652	6510006360	CONNECTOR TMP-J02X-A1
J1051	6510018960	S.CONNECTOR B2B-PH-SM3-TB
J1101	6510021720	S.CONNECTOR 30FLT-SM1-TB
J1151	6510021720	S.CONNECTOR 30FLT-SM1-TB
J1301	6510022560	CONNECTOR 16FMN-BTRK-A
J1351	6510022560	CONNECTOR 16FMN-BTRK-A
J1401	6450001730	CONNECTOR HSJ0912-01-040
J1403	6450000140	CONNECTOR HSJ0807-01-010
J1561	6450001840	CONNECTOR TCS7568-43-201
J1571	6450001840	CONNECTOR TCS7568-43-201
J1581	6450000170	CONNECTOR TCS4480-01-1111
J1751	6510018970	S.CONNECTOR B4B-PH-SM3-TB
J1761	6510018970	S.CONNECTOR B4B-PH-SM3-TB
J1771	6510022630	CONNECTOR 10FMN-BTRK-A
J1781	6510022630	CONNECTOR 10FMN-BTRK-A
J1801	6510019190	S.CONNECTOR 52365-0891
J1851	6450000140	CONNECTOR HSJ0807-01-010
J1852	6450000140	CONNECTOR HSJ0807-01-010
J1853	6510018960	S.CONNECTOR B2B-PH-SM3-TB
W201	7030003860	S.JUMPER ERJ3GE JPW V
W264	7030003860	S.JUMPER ERJ3GE JPW V
W461	7030003860	S.JUMPER ERJ3GE JPW V
W483	7030003860	S.JUMPER ERJ3GE JPW V
W484	7030003860	S.JUMPER ERJ3GE JPW V
W1003	7030003860	S.JUMPER ERJ3GE JPW V
W1004	7030003860	S.JUMPER ERJ3GE JPW V
W1011	7030003860	S.JUMPER ERJ3GE JPW V
W1531	7030003860	S.JUMPER ERJ3GE JPW V
W1601	7030003860	S.JUMPER ERJ3GE JPW V
W1701	7030003860	S.JUMPER ERJ3GE JPW V
W1832	7030003860	S.JUMPER ERJ3GE JPW V
WS1	8600036720	E.OTHER SX2355 P1201×J1201×1251MA
WS2	8970023840	E.OTHER SX2355 ICOM SHIELD (1)/MA
EP1	0910052705	PCB B 5465E

S.=Surface mount

[PA UNIT]

REF NO.	ORDER NO.	DESCRIPTION
L71	6200002630	S.COIL NL 252018T-R10J
L72	6200002840	S.COIL NL 252018T-R22J
L97	6200005680	S.COIL ELJRE 15NG-F
L102	6200004960	S.COIL NL 252018T-R33J
L103	6200008570	S.COIL LQN21A 6N8D04
L117	6200008910	S.COIL 1812CS-122XKBC
L118	6200008910	S.COIL 1812CS-122XKBC
L122	6200003950	S.COIL HF50ACC 322513-T
L123	6200007790	S.COIL LQN21A R15J04
L130	6110001660	COIL LA-252
L131	2040000490	COIL EXC-ELDR25C
L132	6110003560	COIL LA-549
L133	2040000490	COIL EXC-ELDR25C
L134	2040000490	COIL EXC-ELDR25C
L151	2040000490	COIL EXC-ELDR25C
L152	2040000490	COIL EXC-ELDR25C
L153	6110001620	COIL LA-245
L154	6110001620	COIL LA-245
L180	6110000410	COIL LA-69
L181	6110000410	COIL LA-69
L182	6200008910	S.COIL 1812CS-122XKBC
L183	6200008910	S.COIL 1812CS-122XKBC
L184	6110001660	COIL LA-252
L185	6200003950	S.COIL HF50ACC 322513-T
L186	6200003950	S.COIL HF50ACC 322513-T
L190	6140002550	S.COIL B4F-617DB-1010=P3
L191	6140002550	S.COIL B4F-617DB-1010=P3
L192	6200001980	S.COIL NL 252018T-1R0J
L194	6200003950	S.COIL HF50ACC 322513-T
L195	6200005650	S.COIL ELJRE 8N2Z-F
L196	6200005680	S.COIL ELJRE 15NG-F
L201	6140003630	S.COIL LR-404 4KBL
L202	6200001980	S.COIL NL 252018T-1R0J
L203	6200007000	S.COIL ELJRE 82NG-F
L205	6200007230	S.COIL LQN21A 15NJ04
L207	6200001980	S.COIL NL 252018T-1R0J
L220	6200003380	S.COIL B4F-617PT-1026=P3
L221	6200001980	S.COIL NL 252018T-1R0J
L222	6140002550	S.COIL B4F-617DB-1010=P3
L223	6200002630	S.COIL NL 252018T-R10J
L224	6200005710	S.COIL ELJRE 27NG-F
L225	6200005710	S.COIL ELJRE 27NG-F
L240	6200005690	S.COIL ELJRE 18NG-F
L241	6200005680	S.COIL ELJRE 15NG-F
L242	6200001980	S.COIL NL 252018T-1R0J
L243	6200009350	S.COIL ELJRE R22G-F3
L244	6200005690	S.COIL ELJRE 18NG-F
L245	6200005690	S.COIL ELJRE 18NG-F
L246	6200005660	S.COIL ELJRE 10NG-F
L247	6200005710	S.COIL ELJRE 27NG-F
L260	6200009320	S.COIL C3328A-12NG-A
L261	6200009320	S.COIL C3328A-12NG-A
L262	6200007230	S.COIL LQN21A 15NJ04
L263	6200001980	S.COIL NL 252018T-1R0J
L264	6200009260	S.COIL C3328A-5NOJ-A
L267	6110001660	COIL LA-252
L268	6200008510	S.COIL 0.30-0.9-4TR 10.5N
L269	6200007700	S.COIL LQN21A 22NJ04
L280	6150005120	S.COIL LS-539
L281	6150005120	S.COIL LS-539
L282	6150005120	S.COIL LS-539
L283	6150005120	S.COIL LS-539
L301	6140003630	S.COIL LR-404 4KBL
L305	6910000670	COIL BL01RN1-A62-001
L306	6910000670	COIL BL01RN1-A62-001
L321	6200005670	S.COIL ELJRE 12NG-F
L381	6200002630	S.COIL NL 252018T-R10J
L382	6200002640	S.COIL NL 252018T-R15J
L391	6200005700	S.COIL ELJRE 22NG-F
L501	6150001480	COIL LS-164
L502	6150001310	COIL LS-145 (2y)it)
L503	6200004790	S.COIL MLF1608D R47K-T
L504	6200008390	S.COIL 0.25-1.9-9TL
L506	6200001980	S.COIL NL 252018T-1R0J
L507	6200003280	S.COIL NL 252018T-2R2J
L510	6200003950	S.COIL HF50ACC 322513-T
L512	6200003280	S.COIL NL 252018T-2R2J
L513	6200008390	S.COIL 0.25-1.9-9TL
L514	6200008180	S.COIL 0.25-1.9-10TL 107N
L515	6200008180	S.COIL 0.25-1.9-10TL 107N
L516	6200007700	S.COIL LQN21A 22NJ04
L517	6200003280	S.COIL NL 252018T-2R2J

[PA UNIT]

REF NO.	ORDER NO.	DESCRIPTION
L518	6200001980	S.COIL NL 252018T-1R0J
L519	6200005730	S.COIL ELJRE 39NG-F
L520	6200005730	S.COIL ELJRE 39NG-F
L521	6150002200	COIL LS-228
L522	6200003380	S.COIL B4F-617PT-1026=P3
L528	6200007790	S.COIL LQN21A R15J04
L529	6200008090	S.COIL LQN21A 68NJ04
L533	6200008390	S.COIL 0.25-1.9-9TL
L560	6200008390	S.COIL 0.25-1.9-9TL
L561	6200007230	S.COIL LQN21A 15NJ04
L581	6200007000	S.COIL ELJRE 82NG-F
L600	6200005730	S.COIL ELJRE 39NG-F
L601	6200005740	S.COIL ELJRE 47NG-F
L620	6200006670	S.COIL ELJRE 68NG-F
L621	6200005740	S.COIL ELJRE 47NG-F
L631	6200002840	S.COIL NL 252018T-R22J
L632	6200002180	S.COIL NL 252018T-R12J
L641	6200008390	S.COIL 0.25-1.9-9TL
L642	6200008390	S.COIL 0.25-1.9-9TL
L651	2040000490	COIL EXC-ELDR25C
L652	6170000070	COIL LW-9
L653	6110001740	COIL LA-263
L654	6110001740	COIL LA-263
L655	6110001360	COIL LA-179
L656	6170000340	COIL LW-33
L657	6110002060	COIL LA-300
L658	2040000490	COIL EXC-ELDR25C
L701	6200003950	S.COIL HF50ACC 322513-T
L710	6200004740	S.COIL NL 252018T-1R2J
L711	6200004740	S.COIL NL 252018T-1R2J
L720	6200008910	S.COIL 1812CS-122XKBC
L721	6110001340	COIL LA-177
L722	6110001340	COIL LA-177
L723	6110001330	COIL LA-176
L950	6200008360	S.COIL 0.25-1.9-13TL
L951	6200008910	S.COIL 1812CS-122XKBC
L952	6200008910	S.COIL 1812CS-122XKBC
R1	7030003440	S.RESISTOR ERJ3GEYJ 102 V (1 kΩ)
R2	7030003410	S.RESISTOR ERJ3GEYJ 561 V (560 Ω)
R3	7310002740	S.TRIMMER RV-150 (RH03A3A14X0FC) 103
R4	7030003440	S.RESISTOR ERJ3GEYJ 102 V (1 kΩ)
R5	7030003440	S.RESISTOR ERJ3GEYJ 102 V (1 kΩ)
R6	7030003320	S.RESISTOR ERJ3GEYJ 101 V (100 Ω)
R8	7030003480	S.RESISTOR ERJ3GEYJ 222 V (2.2 kΩ)
R9	7030003360	S.RESISTOR ERJ3GEYJ 221 V (220 Ω)
R10	7030003360	S.RESISTOR ERJ3GEYJ 221 V (220 Ω)
R11	7030003480	S.RESISTOR ERJ3GEYJ 222 V (2.2 kΩ)
R12	7030004030	S.RESISTOR ERJ3GEYJ 5R6 V (5.6 Ω)
R13	7030003430	S.RESISTOR ERJ3GEYJ 821 V (820 Ω)
R14	7030003430	S.RESISTOR ERJ3GEYJ 821 V (820 Ω)
R27	7030003280	S.RESISTOR ERJ3GEYJ 470 V (47 Ω)
R28	7030003320	S.RESISTOR ERJ3GEYJ 101 V (100 Ω)
R30	7030003440	S.RESISTOR ERJ3GEYJ 102 V (1 kΩ)
R31	7030003440	S.RESISTOR ERJ3GEYJ 102 V (1 kΩ)
R32	7030003520	S.RESISTOR ERJ3GEYJ 472 V (4.7 kΩ)
R37	7030003640	S.RESISTOR ERJ3GEYJ 473 V (4.7 kΩ)
R38	7030003420	S.RESISTOR ERJ3GEYJ 681 V (680 Ω)
R39	7030003440	S.RESISTOR ERJ3GEYJ 102 V (1 kΩ)
R40	7030003500	S.RESISTOR ERJ3GEYJ 332 V (3.3 kΩ)
R42	7030003400	S.RESISTOR ERJ3GEYJ 471 V (470 Ω)
R43	7030003200	S.RESISTOR ERJ3GEYJ 100 V (10 Ω)
R44	7030003400	S.RESISTOR ERJ3GEYJ 471 V (470 Ω)
R60	7030003480	S.RESISTOR ERJ3GEYJ 222 V (2.2 kΩ)
R61	7310002670	S.TRIMMER RV-143 (RH03A3AS2) 471
R62	7030003560	S.RESISTOR ERJ3GEYJ 103 V (10 kΩ)
R63	7030003410	S.RESISTOR ERJ3GEYJ 561 V (560 Ω)
R64	7510001250	S.THERMISTOR NTCM1608 3NH 471KC
R65	7030003390	S.RESISTOR ERJ3GEYJ 391 V (390 Ω)
R66	7030003470	S.RESISTOR ERJ3GEYJ 182 V (1.8 kΩ)
R67	7030003470	S.RESISTOR ERJ3GEYJ 182 V (1.8 kΩ)
R68	7030003320	S.RESISTOR ERJ3GEYJ 101 V (100 Ω)
R80	7030003520	S.RESISTOR ERJ3GEYJ 472 V (4.7 kΩ)
R100	7030003380	S.RESISTOR ERJ3GEYJ 331 V (330 Ω)
R101	7030003380	S.RESISTOR ERJ3GEYJ 331 V (330 Ω)
R102	7030003230	S.RESISTOR ERJ3GEYJ 180 V (18 Ω)
R103	7030003380	S.RESISTOR ERJ3GEYJ 331 V (330 Ω)
R104	7030003300	S.RESISTOR ERJ3GEYJ 680 V (68 Ω)
R105	7030003480	S.RESISTOR ERJ3GEYJ 222 V (2.2 kΩ)
R106	7030003520	S.RESISTOR ERJ3GEYJ 472 V (4.7 kΩ)
R107	7030003420	S.RESISTOR ERJ3GEYJ 681 V (680 Ω)

S.=Surface mount

[PA UNIT]

REF NO.	ORDER NO.	DESCRIPTION	
F300	5210000130	FUSE	FGB 4A
F301	5220000230	HOLDER	S-N5054 #01
F302	5220000230	HOLDER	S-N5054 #01
W3	7030003860	S.JUMPER	ERJ3GE JPW V
W5	7030003860	S.JUMPER	ERJ3GE JPW V
W7	7030003860	S.JUMPER	ERJ3GE JPW V
W60	7030008240	S.JUMPER	ERJ12YJ0R00U
W61	7030008240	S.JUMPER	ERJ12YJ0R00U
W62	7030008240	S.JUMPER	ERJ12YJ0R00U
W63	7030008240	S.JUMPER	ERJ12YJ0R00U
W64	7030000010	S.JUMPER	MCR10EZHZ JPW (000)
W202	7030008240	S.JUMPER	ERJ12YJ0R00U
W232	7030003860	S.JUMPER	ERJ3GE JPW V
W261	7030008240	S.JUMPER	ERJ12YJ0R00U
W262	7030008240	S.JUMPER	ERJ12YJ0R00U
W305	8900010421	CABLE	OPC-992A
W331	7030003860	S.JUMPER	ERJ3GE JPW V
W332	7030003860	S.JUMPER	ERJ3GE JPW V
W333	7030003860	S.JUMPER	ERJ3GE JPW V
W513	7030008240	S.JUMPER	ERJ12YJ0R00U
W520	7030008240	S.JUMPER	ERJ12YJ0R00U
W521	7030008240	S.JUMPER	ERJ12YJ0R00U
W557	7030003860	S.JUMPER	ERJ3GE JPW V
W558	7030003860	S.JUMPER	ERJ3GE JPW V
W559	7030003860	S.JUMPER	ERJ3GE JPW V
W951	7030000010	S.JUMPER	MCR10EZHZ JPW (000)
W952	7030003860	S.JUMPER	ERJ3GE JPW V
WS1	8970023780	E.OTHER	SX2355 1.5D COAXIAL TUBE (1)/PA
WS2	8970023790	E.OTHER	SX2355 1.5D COAXIAL TUBE (1)/PA
WS3	8970023800	E.OTHER	SX2355 1.5D COAXIAL TUBE (2)/PA
WS5	8600036730	E.OTHER	SX2355 P50×J50PA
WS6	8970023820	E.OTHER	SX2355 COAXIAL TUBE (1)/PA
WS7	8600036740	E.OTHER	SX2355 P300×J600-603PA
EP2	0910053576	PCB	B 5573F
EP31	6910012350	S.BEAD	MMZ1608Y 102BT
EP32	6910012350	S.BEAD	MMZ1608Y 102BT
EP50	6910012350	S.BEAD	MMZ1608Y 102BT
EP51	6910012350	S.BEAD	MMZ1608Y 102BT
EP52	6910012350	S.BEAD	MMZ1608Y 102BT
EP53	6910012350	S.BEAD	MMZ1608Y 102BT
EP54	6910012350	S.BEAD	MMZ1608Y 102BT
EP55	6910012350	S.BEAD	MMZ1608Y 102BT
EP56	6910012350	S.BEAD	MMZ1608Y 102BT
EP61	6910012350	S.BEAD	MMZ1608Y 102BT
EP153	6910000610	BEAD	FSOH050RN01
EP154	6910000610	BEAD	FSOH050RN01
EP181	6910012350	S.BEAD	MMZ1608Y 102BT
EP193	6910012350	S.BEAD	MMZ1608Y 102BT
EP195	6910012350	S.BEAD	MMZ1608Y 102BT
EP201	6910012350	S.BEAD	MMZ1608Y 102BT
EP220	6910012350	S.BEAD	MMZ1608Y 102BT
EP221	6910012350	S.BEAD	MMZ1608Y 102BT
EP243	6910012350	S.BEAD	MMZ1608Y 102BT
EP245	6910012350	S.BEAD	MMZ1608Y 102BT
EP290	6910012350	S.BEAD	MMZ1608Y 102BT
EP330	6910012350	S.BEAD	MMZ1608Y 102BT
EP341	6910012350	S.BEAD	MMZ1608Y 102BT
EP342	6910012350	S.BEAD	MMZ1608Y 102BT
EP401	6910012350	S.BEAD	MMZ1608Y 102BT
EP406	6910012350	S.BEAD	MMZ1608Y 102BT
EP517	6910012350	S.BEAD	MMZ1608Y 102BT
EP561	6910012350	S.BEAD	MMZ1608Y 102BT
EP562	6910012350	S.BEAD	MMZ1608Y 102BT
EP563	6910012350	S.BEAD	MMZ1608Y 102BT
EP564	6910012350	S.BEAD	MMZ1608Y 102BT
EP565	6910012350	S.BEAD	MMZ1608Y 102BT
EP566	6910012350	S.BEAD	MMZ1608Y 102BT
EP567	6910012350	S.BEAD	MMZ1608Y 102BT
EP568	6910012350	S.BEAD	MMZ1608Y 102BT
EP569	6910012350	S.BEAD	MMZ1608Y 102BT
EP911	6910012350	S.BEAD	MMZ1608Y 102BT

[DRV BOARD]

REF NO.	ORDER NO.	DESCRIPTION	
Q930	1560001030	S.FET	2SK2975 (MTS103)
R90	7030010140	S.RESISTOR	ERJ1WYJ201U (200 Ω)
R91	7030000230	S.RESISTOR	MCR10EZHZ 56 Ω (560)
C90	4030004710	S.CERAMIC	C2012 JB 1H 471K-T-A
C91	4030004720	S.CERAMIC	C2012 JB 1H 102K-T-A
EP1	0910052723	PCB	B 5474C

[BARISTOR-A BOARD]

REF NO.	ORDER NO.	DESCRIPTION	
D1	1790000710	VARISTOR	MA29B
EP1	0910053583	PCB	B 5576C
EP2	6910012350	S.BEAD	MMZ1608Y 102BT

[VARISTOR-B BOARD]

REF NO.	ORDER NO.	DESCRIPTION	
D1	1790000710	VARISTOR	MA29B
EP1	0910053593	PCB	B 5577C
EP2	6910012350	S.BEAD	MMZ1608Y 102BT

[BARISTOR-C BOARD]

REF NO.	ORDER NO.	DESCRIPTION	
D1	1790000710	VARISTOR	MA29B
C1	4030006860	S.CERAMIC	C1608 JB 1H 102K-T-A
EP1	0910053601	PCB	B 5578A
EP2	9036505001	TUBE	IRRAX 0.7 (d) L=15 mm

S.=Surface mount

[MAIN UNIT] — UX-910

REF NO.	ORDER NO.		DESCRIPTION
L285	6200006050	S.COIL	LQP11A 6N8C00
L286	6200006020	S.COIL	LQP11A 3N9C00
L287	6200006030	S.COIL	LQP11A 4N7C00
L289	6200006100	S.COIL	LQP11A 18NG00
L311	2040000490	COIL	EXC-ELDR25C
L501	6200001830	S.COIL	NL 322522T-100J
L511	6200001830	S.COIL	NL 322522T-100J
L512	6200002630	S.COIL	NL 252018T-R10J
L531	6200005660	S.COIL	ELJRE 10NG-F
L542	6200009390	S.COIL	C3328A-8N0J-A
L555	6200006990	S.COIL	ELJRE 56NG-F
L571	6200005650	S.COIL	ELJRE 8N2Z-F
L572	6200005640	S.COIL	ELJRE 6N8Z-F
L581	6200005640	S.COIL	ELJRE 6N8Z-F
L582	6200005650	S.COIL	ELJRE 8N2Z-F
L602	6200005010	S.COIL	NL 252018T-100J
L603	6200004960	S.COIL	NL 252018T-R33J
L604	6200003660	S.COIL	NL 252018T-R68J
L610	6200002840	S.COIL	NL 252018T-R22J
L611	6200002850	S.COIL	NL 252018T-R82J
L612	6200003270	S.COIL	NL 252018T-R56J
L621	6200005010	S.COIL	NL 252018T-100J
L622	6200005520	S.COIL	NL 252018T-470J
L641	6200005660	S.COIL	ELJRE 10NG-F
L642	6200005650	S.COIL	ELJRE 8N2Z-F
L651	6200005050	S.COIL	NL 252018T-330J
L652	6200009210	S.COIL	NL 252018T-390J
L653	6200009210	S.COIL	NL 252018T-390J
L661	6200001830	S.COIL	NL 322522T-100J
L702	6200005010	S.COIL	NL 252018T-100J
L703	6200005010	S.COIL	NL 252018T-100J
L711	6200002630	S.COIL	NL 252018T-R10J
L712	6200009380	S.COIL	C6328A-43NG 43N
L741	6200007000	S.COIL	ELJRE 82NG-F
L743	6200005720	S.COIL	ELJRE 33NG-F
L751	6200005710	S.COIL	ELJRE 27NG-F
L761	6200002610	S.COIL	NL 252018T-R47J
L762	6200005010	S.COIL	NL 252018T-100J
L771	6200005010	S.COIL	NL 252018T-100J
R2	7030003430	S.RESISTOR	ERJ3GEYJ 821 V (820 Ω)
R3	7030004030	S.RESISTOR	ERJ3GEYJ 5R6 V (5.6 Ω)
R4	7030003290	S.RESISTOR	ERJ3GEYJ 560 V (56 Ω)
R5	7030003460	S.RESISTOR	ERJ3GEYJ 152 V (1.5 kΩ)
R6	7030003520	S.RESISTOR	ERJ3GEYJ 472 V (4.7 kΩ)
R7	7030003360	S.RESISTOR	ERJ3GEYJ 221 V (220 Ω)
R8	7030003340	S.RESISTOR	ERJ3GEYJ 151 V (150 Ω)
R11	7030003360	S.RESISTOR	ERJ3GEYJ 221 V (220 Ω)
R12	7030003490	S.RESISTOR	ERJ3GEYJ 272 V (2.7 kΩ)
R13	7310002720	S.TRIMMER	RV-148 (RH03A3AS3X0DA) 472
R14	7030003440	S.RESISTOR	ERJ3GEYJ 102 V (1 kΩ)
R15	7030000140	S.RESISTOR	MCR10EZHJ 10 Ω (100)
R16	7030000140	S.RESISTOR	MCR10EZHJ 10 Ω (100)
R17	7030000240	S.RESISTOR	MCR10EZHJ 68 Ω (680)
R18	7030000240	S.RESISTOR	MCR10EZHJ 68 Ω (680)
R19	7030000240	S.RESISTOR	MCR10EZHJ 68 Ω (680)
R31	7080000150	RESISTOR	RGB3L R15
R32	7030003440	S.RESISTOR	ERJ3GEYJ 102 V (1 kΩ)
R33	7030003440	S.RESISTOR	ERJ3GEYJ 102 V (1 kΩ)
R34	7030005681	S.RESISTOR	ERA3YKD 473V (47 kΩ)
R35	7030005681	S.RESISTOR	ERA3YKD 473V (47 kΩ)
R36	7030005981	S.RESISTOR	ERA3YKD 333V (33 kΩ)
R37	7310002720	S.TRIMMER	RV-148 (RH03A3AS3X0DA) 472
R38	7030005981	S.RESISTOR	ERA3YKD 333V (33 kΩ)
R39	7030003760	S.RESISTOR	ERJ3GEYJ 474 V (470 kΩ)
R40	7030003440	S.RESISTOR	ERJ3GEYJ 102 V (1 kΩ)
R41	7030003320	S.RESISTOR	ERJ3GEYJ 101 V (100 Ω)
R42	7030003320	S.RESISTOR	ERJ3GEYJ 101 V (100 Ω)
R43	7030003400	S.RESISTOR	ERJ3GEYJ 471 V (470 Ω)
R44	7510001160	S.THERMISTOR	NTCCM1608 4LH 473KC
R45	7030003560	S.RESISTOR	ERJ3GEYJ 103 V (10 kΩ)
R46	7030003440	S.RESISTOR	ERJ3GEYJ 102 V (1 kΩ)
R51	7030003560	S.RESISTOR	ERJ3GEYJ 103 V (10 kΩ)
R52	7030003560	S.RESISTOR	ERJ3GEYJ 103 V (10 kΩ)
R53	7030003600	S.RESISTOR	ERJ3GEYJ 223 V (22 kΩ)
R54	7030003440	S.RESISTOR	ERJ3GEYJ 102 V (1 kΩ)
R61	7310002740	S.TRIMMER	RV-150 (RH03A3A14X0FC) 103
R62	7030000260	S.RESISTOR	MCR10EZHJ 100 Ω (101)
R65	7030000200	S.RESISTOR	MCR10EZHJ 33 Ω (330)
R67	7310002740	S.TRIMMER	RV-150 (RH03A3A14X0FC) 103
R71	7030003500	S.RESISTOR	ERJ3GEYJ 332 V (3.3 kΩ)

[MAIN UNIT] — UX-910

REF NO.	ORDER NO.		DESCRIPTION
R72	70300008180	S.RESISTOR	ERJ12YJ331U (330 Ω)
R73	7030010260	S.RESISTOR	ERJ1TYJ 3R3 U (3.3 Ω)
R74	7030003400	S.RESISTOR	ERJ3GEYJ 471 V (470 Ω)
R75	7030003500	S.RESISTOR	ERJ3GEYJ 332 V (3.3 kΩ)
R76	7030003540	S.RESISTOR	ERJ3GEYJ 682 V (6.8 kΩ)
R77	7030003500	S.RESISTOR	ERJ3GEYJ 332 V (3.3 kΩ)
R81	7030003480	S.RESISTOR	ERJ3GEYJ 222 V (2.2 kΩ)
R83	7310002670	S.TRIMMER	RV-143 (RH03A3AS2) 471
R84	7030003290	S.RESISTOR	ERJ3GEYJ 560 V (56 Ω)
R85	7030003440	S.RESISTOR	ERJ3GEYJ 102 V (1 kΩ)
R86	7030003370	S.RESISTOR	ERJ3GEYJ 271 V (270 Ω)
R87	7030003230	S.RESISTOR	ERJ3GEYJ 180 V (18 Ω)
R88	7030003370	S.RESISTOR	ERJ3GEYJ 271 V (270 Ω)
R89	7030003560	S.RESISTOR	ERJ3GEYJ 103 V (10 kΩ)
R90	7030003590	S.RESISTOR	ERJ3GEYJ 183 V (18 kΩ)
R91	7030003320	S.RESISTOR	ERJ3GEYJ 101 V (100 Ω)
R92	7030003320	S.RESISTOR	ERJ3GEYJ 101 V (100 Ω)
R93	7030003360	S.RESISTOR	ERJ3GEYJ 221 V (220 Ω)
R100	7030003290	S.RESISTOR	ERJ3GEYJ 560 V (56 Ω)
R101	7030003430	S.RESISTOR	ERJ3GEYJ 821 V (820 Ω)
R102	7030004030	S.RESISTOR	ERJ3GEYJ 5R6 V (5.6 Ω)
R103	7030003430	S.RESISTOR	ERJ3GEYJ 821 V (820 Ω)
R104	7030003370	S.RESISTOR	ERJ3GEYJ 271 V (270 Ω)
R105	7030003230	S.RESISTOR	ERJ3GEYJ 180 V (18 Ω)
R106	7030003370	S.RESISTOR	ERJ3GEYJ 271 V (270 Ω)
R130	7030003310	S.RESISTOR	ERJ3GEYJ 820 V (82 Ω)
R131	7030003440	S.RESISTOR	ERJ3GEYJ 102 V (1 kΩ)
R133	7030003430	S.RESISTOR	ERJ3GEYJ 821 V (820 Ω)
R134	7030004030	S.RESISTOR	ERJ3GEYJ 5R6 V (5.6 Ω)
R135	7030003430	S.RESISTOR	ERJ3GEYJ 821 V (820 Ω)
R136	7030003370	S.RESISTOR	ERJ3GEYJ 271 V (270 Ω)
R137	7030003230	S.RESISTOR	ERJ3GEYJ 180 V (18 Ω)
R138	7030003370	S.RESISTOR	ERJ3GEYJ 271 V (270 Ω)
R139	7030003290	S.RESISTOR	ERJ3GEYJ 560 V (56 Ω)
R144	7030003430	S.RESISTOR	ERJ3GEYJ 821 V (820 Ω)
R145	7030004030	S.RESISTOR	ERJ3GEYJ 5R6 V (5.6 Ω)
R146	7030003290	S.RESISTOR	ERJ3GEYJ 560 V (56 Ω)
R161	7030003480	S.RESISTOR	ERJ3GEYJ 222 V (2.2 kΩ)
R162	7030003480	S.RESISTOR	ERJ3GEYJ 222 V (2.2 kΩ)
R163	7030003440	S.RESISTOR	ERJ3GEYJ 102 V (1 kΩ)
R164	7030003560	S.RESISTOR	ERJ3GEYJ 103 V (10 kΩ)
R165	7030003440	S.RESISTOR	ERJ3GEYJ 102 V (1 kΩ)
R166	7030006260	S.RESISTOR	ERJ12YJ471U (470 Ω)
R167	7030003680	S.RESISTOR	ERJ3GEYJ 104 V (100 kΩ)
R168	7030003440	S.RESISTOR	ERJ3GEYJ 102 V (1 kΩ)
R169	7030003680	S.RESISTOR	ERJ3GEYJ 104 V (100 kΩ)
R181	7030003440	S.RESISTOR	ERJ3GEYJ 102 V (1 kΩ)
R184	7030003370	S.RESISTOR	ERJ3GEYJ 271 V (270 Ω)
R185	7030003230	S.RESISTOR	ERJ3GEYJ 180 V (18 Ω)
R186	7030003370	S.RESISTOR	ERJ3GEYJ 271 V (270 Ω)
R201	7030003440	S.RESISTOR	ERJ3GEYJ 102 V (1 kΩ)
R204	7030003330	S.RESISTOR	ERJ3GEYJ 121 V (120 Ω)
R205	7030003290	S.RESISTOR	ERJ3GEYJ 560 V (56 Ω)
R206	7030003330	S.RESISTOR	ERJ3GEYJ 121 V (120 Ω)
R221	7030003480	S.RESISTOR	ERJ3GEYJ 222 V (2.2 kΩ)
R222	7030003330	S.RESISTOR	ERJ3GEYJ 121 V (120 Ω)
R223	7030003320	S.RESISTOR	ERJ3GEYJ 101 V (100 Ω)
R224	7310002690	S.TRIMMER	RV-145 (RH03A3A13X0CA) 102
R226	7030003320	S.RESISTOR	ERJ3GEYJ 101 V (100 Ω)
R227	7030003560	S.RESISTOR	ERJ3GEYJ 103 V (10 kΩ)
R228	7030003680	S.RESISTOR	ERJ3GEYJ 104 V (100 kΩ)
R229	7030003440	S.RESISTOR	ERJ3GEYJ 102 V (1 kΩ)
R230	7030003370	S.RESISTOR	ERJ3GEYJ 271 V (270 Ω)
R231	7030003230	S.RESISTOR	ERJ3GEYJ 180 V (18 Ω)
R232	7030003370	S.RESISTOR	ERJ3GEYJ 271 V (270 Ω)
R242	7030003370	S.RESISTOR	ERJ3GEYJ 271 V (270 Ω)
R243	7030003230	S.RESISTOR	ERJ3GEYJ 180 V (18 Ω)
R244	7030003370	S.RESISTOR	ERJ3GEYJ 271 V (270 Ω)
R245	7030003440	S.RESISTOR	ERJ3GEYJ 102 V (1 kΩ)
R246	7030003200	S.RESISTOR	ERJ3GEYJ 100 V (10 Ω)
R247	7030003320	S.RESISTOR	ERJ3GEYJ 101 V (100 Ω)
R248	7030003480	S.RESISTOR	ERJ3GEYJ 222 V (2.2 kΩ)
R271	7030003360	S.RESISTOR	ERJ3GEYJ 221 V (220 Ω)
R272	7030003340	S.RESISTOR	ERJ3GEYJ 151 V (150 Ω)
R273	7030003560	S.RESISTOR	ERJ3GEYJ 103 V (10 kΩ)
R274	7030003540	S.RESISTOR	ERJ3GEYJ 682 V (6.8 kΩ)
R281	7030003320	S.RESISTOR	ERJ3GEYJ 101 V (100 Ω)
R282	7030003200	S.RESISTOR	ERJ3GEYJ 100 V (10 Ω)
R283	7030003330	S.RESISTOR	ERJ3GEYJ 121 V (120 Ω)
R284	7030003300	S.RESISTOR	ERJ3GEYJ 680 V (68 Ω)
R285	7030003440	S.RESISTOR	ERJ3GEYJ 102 V (1 kΩ)
R287	7030003320	S.RESISTOR	ERJ3GEYJ 101 V (100 Ω)

S.=Surface mount

[MAIN UNIT] — UX-910

REF NO.	ORDER NO.	DESCRIPTION
R288	7310002670	S.TRIMMER RV-143 (RH03A3AS2) 471
R301	7030003320	S.RESISTOR ERJ3GEYJ 101 V (100 Ω)
R311	7030003520	S.RESISTOR ERJ3GEYJ 472 V (4.7 kΩ)
R312	7030003510	S.RESISTOR ERJ3GEYJ 392 V (3.9 kΩ)
R342	7030003440	S.RESISTOR ERJ3GEYJ 102 V (1 kΩ)
R501	7030003440	S.RESISTOR ERJ3GEYJ 102 V (1 kΩ)
R502	7030003440	S.RESISTOR ERJ3GEYJ 102 V (1 kΩ)
R503	7030003440	S.RESISTOR ERJ3GEYJ 102 V (1 kΩ)
R504	7030003440	S.RESISTOR ERJ3GEYJ 102 V (1 kΩ)
R505	7030003520	S.RESISTOR ERJ3GEYJ 472 V (4.7 kΩ)
R506	7030003420	S.RESISTOR ERJ3GEYJ 681 V (680 Ω)
R511	7030005331	S.RESISTOR ERA3YED 562V
R512	7030008061	S.RESISTOR ERA3YED 222V
R514	7030009661	S.RESISTOR ERA3YED 121V (120 Ω)
R515	7030003200	S.RESISTOR ERJ3GEYJ 100 V (10 Ω)
R516	7030003470	S.RESISTOR ERJ3GEYJ 182 V (1.8 kΩ)
R517	7030003440	S.RESISTOR ERJ3GEYJ 102 V (1 kΩ)
R518	7030009661	S.RESISTOR ERA3YED 121V (120 Ω)
R519	7030006581	S.RESISTOR ERA3YED 122V
R531	7030003360	S.RESISTOR ERJ3GEYJ 221 V (220 Ω)
R533	7030003320	S.RESISTOR ERJ3GEYJ 101 V (100 Ω)
R541	7030003540	S.RESISTOR ERJ3GEYJ 682 V (6.8 kΩ)
R542	7030003540	S.RESISTOR ERJ3GEYJ 682 V (6.8 kΩ)
R543	7030003540	S.RESISTOR ERJ3GEYJ 682 V (6.8 kΩ)
R544	7030003400	S.RESISTOR ERJ3GEYJ 471 V (470 Ω)
R547	7030003280	S.RESISTOR ERJ3GEYJ 470 V (47 Ω)
R551	7030003600	S.RESISTOR ERJ3GEYJ 223 V (22 kΩ)
R553	7030003240	S.RESISTOR ERJ3GEYJ 220 V (22 Ω)
R554	7030003280	S.RESISTOR ERJ3GEYJ 470 V (47 Ω)
R555	7030003320	S.RESISTOR ERJ3GEYJ 101 V (100 Ω)
R556	7030003360	S.RESISTOR ERJ3GEYJ 221 V (220 Ω)
R557	7030003240	S.RESISTOR ERJ3GEYJ 220 V (22 Ω)
R603	7030003800	S.RESISTOR ERJ3GEYJ 105 V (1 MΩ)
R604	7030003320	S.RESISTOR ERJ3GEYJ 101 V (100 Ω)
R605	7030003360	S.RESISTOR ERJ3GEYJ 221 V (220 Ω)
R606	7030005981	S.RESISTOR ERA3YKD 333V (33 kΩ)
R607	7030003480	S.RESISTOR ERJ3GEYJ 222 V (2.2 kΩ)
R610	7030003320	S.RESISTOR ERJ3GEYJ 101 V (100 Ω)
R611	7030003320	S.RESISTOR ERJ3GEYJ 101 V (100 Ω)
R612	7030003300	S.RESISTOR ERJ3GEYJ 680 V (68 Ω)
R613	7030003320	S.RESISTOR ERJ3GEYJ 101 V (100 Ω)
R621	7030007230	S.RESISTOR ERA3YED 102V
R622	7030007230	S.RESISTOR ERA3YED 102V
R623	7030007230	S.RESISTOR ERA3YED 102V
R624	7030007230	S.RESISTOR ERA3YED 102V
R625	7030007230	S.RESISTOR ERA3YED 102V
R626	7030007230	S.RESISTOR ERA3YED 102V
R627	7030007230	S.RESISTOR ERA3YED 102V
R628	7030007210	S.RESISTOR ERA3YEB 102V
R629	7030007210	S.RESISTOR ERA3YEB 102V
R630	7030007210	S.RESISTOR ERA3YEB 102V
R631	7030007210	S.RESISTOR ERA3YEB 102V
R633	7030007220	S.RESISTOR ERA3YED 202V
R634	7030007220	S.RESISTOR ERA3YED 202V
R635	7030007220	S.RESISTOR ERA3YED 202V
R636	7030007220	S.RESISTOR ERA3YED 202V
R637	7030007220	S.RESISTOR ERA3YED 202V
R638	7030007220	S.RESISTOR ERA3YED 202V
R639	7030007220	S.RESISTOR ERA3YED 202V
R640	7030007220	S.RESISTOR ERA3YED 202V
R641	7030007220	S.RESISTOR ERA3YED 202V
R642	7030007220	S.RESISTOR ERA3YED 202V
R643	7030007200	S.RESISTOR ERA3YEB 202V
R644	7030007200	S.RESISTOR ERA3YEB 202V
R645	7030007200	S.RESISTOR ERA3YEB 202V
R648	7030003530	S.RESISTOR ERJ3GEYJ 562 V (5.6 kΩ)
R651	7030003440	S.RESISTOR ERJ3GEYJ 102 V (1 kΩ)
R652	7030003340	S.RESISTOR ERJ3GEYJ 151 V (150 Ω)
R661	7030003440	S.RESISTOR ERJ3GEYJ 102 V (1 kΩ)
R662	7030003440	S.RESISTOR ERJ3GEYJ 102 V (1 kΩ)
R663	7030003440	S.RESISTOR ERJ3GEYJ 102 V (1 kΩ)
R664	7030003440	S.RESISTOR ERJ3GEYJ 102 V (1 kΩ)
R681	7030003290	S.RESISTOR ERJ3GEYJ 560 V (56 Ω)
R682	7030003290	S.RESISTOR ERJ3GEYJ 560 V (56 Ω)
R683	7030005681	S.RESISTOR ERA3YKD 473V (47 kΩ)
R684	7030003320	S.RESISTOR ERJ3GEYJ 101 V (100 Ω)
R701	7030003440	S.RESISTOR ERJ3GEYJ 102 V (1 kΩ)
R702	7030003400	S.RESISTOR ERJ3GEYJ 471 V (470 Ω)
R719	7030003440	S.RESISTOR ERJ3GEYJ 102 V (1 kΩ)
R722	7030005321	S.RESISTOR ERA3YED 103V (10 kΩ)
R723	7030005321	S.RESISTOR ERA3YED 103V (10 kΩ)
R724	7030009891	S.RESISTOR ERA3YED 151V

[MAIN UNIT] — UX-910

REF NO.	ORDER NO.	DESCRIPTION
R726	7030009891	S.RESISTOR ERA3YED 151V
R727	7030003320	S.RESISTOR ERJ3GEYJ 101 V (100 Ω)
R728	7030003440	S.RESISTOR ERJ3GEYJ 102 V (1 kΩ)
R729	7030003840	S.RESISTOR ERJ3GEYJ 225 V (2.2 MΩ)
R731	7030003490	S.RESISTOR ERJ3GEYJ 272 V (2.7 kΩ)
R732	7030003440	S.RESISTOR ERJ3GEYJ 102 V (1 kΩ)
R733	7030003380	S.RESISTOR ERJ3GEYJ 331 V (330 Ω)
R734	7030003320	S.RESISTOR ERJ3GEYJ 101 V (100 Ω)
R741	7030003510	S.RESISTOR ERJ3GEYJ 392 V (3.9 kΩ)
R742	7030003460	S.RESISTOR ERJ3GEYJ 152 V (1.5 kΩ)
R743	7030003320	S.RESISTOR ERJ3GEYJ 101 V (100 Ω)
R744	7030003320	S.RESISTOR ERJ3GEYJ 101 V (100 Ω)
R746	7030003220	S.RESISTOR ERJ3GEYJ 150 V (15 Ω)
R748	7030003220	S.RESISTOR ERJ3GEYJ 150 V (15 Ω)
R750	7030003220	S.RESISTOR ERJ3GEYJ 150 V (15 Ω)
R751	7030003360	S.RESISTOR ERJ3GEYJ 221 V (220 Ω)
R761	7030005680	S.RESISTOR RR0816R-473-D (47 kΩ)
R762	7030003320	S.RESISTOR ERJ3GEYJ 101 V (100 Ω)
R763	7030003360	S.RESISTOR ERJ3GEYJ 221 V (220 Ω)
R764	7030003290	S.RESISTOR ERJ3GEYJ 560 V (56 Ω)
R765	7030003800	S.RESISTOR ERJ3GEYJ 105 V (1 MΩ)
R766	7030003480	S.RESISTOR ERJ3GEYJ 222 V (2.2 kΩ)
R771	7030003440	S.RESISTOR ERJ3GEYJ 102 V (1 kΩ)
R772	7030003440	S.RESISTOR ERJ3GEYJ 102 V (1 kΩ)
R773	7030003680	S.RESISTOR ERJ3GEYJ 104 V (100 kΩ)
C1	4030006850	S.CERAMIC C1608 JB 1H 471K-T-A
C2	4030009910	S.CERAMIC C1608 CH 1H 040B-T-A
C3	4030009510	S.CERAMIC C1608 CH 1H 010B-T-A
C4	4030007010	S.CERAMIC C1608 CH 1H 100D-T-A
C5	4030007090	S.CERAMIC C1608 CH 1H 470J-T-A
C6	4030007010	S.CERAMIC C1608 CH 1H 100D-T-A
C7	4030009520	S.CERAMIC C1608 CH 1H 020B-T-A
C8	4030009910	S.CERAMIC C1608 CH 1H 040B-T-A
C9	4030011770	S.CERAMIC C1608 CH 1H 060B-T-A
C11	4030007130	S.CERAMIC C1608 CH 1H 101J-T-A
C12	4030006980	S.CERAMIC C1608 CH 1H 070D-T-A
C13	4030007010	S.CERAMIC C1608 CH 1H 100D-T-A
C14	4030007090	S.CERAMIC C1608 CH 1H 470J-T-A
C15	4030007090	S.CERAMIC C1608 CH 1H 470J-T-A
C16	4030007130	S.CERAMIC C1608 CH 1H 101J-T-A
C17	4030009910	S.CERAMIC C1608 CH 1H 040B-T-A
C18	4030006980	S.CERAMIC C1608 CH 1H 070D-T-A
C19	4030007090	S.CERAMIC C1608 CH 1H 470J-T-A
C20	4030007010	S.CERAMIC C1608 CH 1H 100D-T-A
C21	4030011770	S.CERAMIC C1608 CH 1H 060B-T-A
C22	4030007010	S.CERAMIC C1608 CH 1H 100D-T-A
C23	4030007010	S.CERAMIC C1608 CH 1H 100D-T-A
C24	4030006880	S.CERAMIC C1608 JB 1H 472K-T-A
C25	4030006860	S.CERAMIC C1608 JB 1H 102K-T-A
C26	4030009520	S.CERAMIC C1608 CH 1H 020B-T-A
C28	4030004770	S.CERAMIC C2012 CH 1H 0R5C-T-A
C30	4510007540	ELECTROLYTIC ECA 1CHG 471
C31	4510007540	ELECTROLYTIC ECA 1CHG 471
C32	4030006850	S.CERAMIC C1608 JB 1H 471K-T-A
C33	4030007010	S.CERAMIC C1608 CH 1H 100D-T-A
C34	4030007090	S.CERAMIC C1608 CH 1H 470J-T-A
C35	4030006880	S.CERAMIC C1608 JB 1H 472K-T-A
C36	4510006220	S.ELECTROLYTIC ECEV1CA101UP
C37	4030007010	S.CERAMIC C1608 CH 1H 100D-T-A
C38	4030006860	S.CERAMIC C1608 JB 1H 102K-T-A
C39	4030006880	S.CERAMIC C1608 JB 1H 472K-T-A
C40	4510004630	S.ELECTROLYTIC ECEV1CA100SR
C41	4030006860	S.CERAMIC C1608 JB 1H 102K-T-A
C42	4030006860	S.CERAMIC C1608 JB 1H 102K-T-A
C43	4030006860	S.CERAMIC C1608 JB 1H 102K-T-A
C44	4030007130	S.CERAMIC C1608 CH 1H 101J-T-A
C45	4030006860	S.CERAMIC C1608 JB 1H 102K-T-A
C46	4030006860	S.CERAMIC C1608 JB 1H 102K-T-A
C47	4030012610	S.CERAMIC C2012 JB 1C 474K-T-A
C48	4030006860	S.CERAMIC C1608 JB 1H 102K-T-A
C49	4030007130	S.CERAMIC C1608 CH 1H 101J-T-A
C50	4030006860	S.CERAMIC C1608 JB 1H 102K-T-A
C53	4030006860	S.CERAMIC C1608 JB 1H 102K-T-A
C55	4030011020	S.CERAMIC GRM42-6 CK 010C 500PT
C56	4510004990	ELECTROLYTIC 16 MV 100 HC
C58	4030006860	S.CERAMIC C1608 JB 1H 102K-T-A
C59	4030007090	S.CERAMIC C1608 CH 1H 470J-T-A
C60	4030007090	S.CERAMIC C1608 CH 1H 470J-T-A
C61	4030006860	S.CERAMIC C1608 JB 1H 102K-T-A
C63	4030006850	S.CERAMIC C1608 JB 1H 471K-T-A

S.=Surface mount

[MAIN UNIT] — UX-910

REF NO.	ORDER NO.	DESCRIPTION	
C65	4030011600	S.CERAMIC	C1608 JB 1C 104KT-N
C66	4030006850	S.CERAMIC	C1608 JB 1H 471K-T-A
C67	4030006860	S.CERAMIC	C1608 JB 1H 102K-T-A
C69	4030007090	S.CERAMIC	C1608 CH 1H 470J-T-A
C70	4030006860	S.CERAMIC	C1608 JB 1H 102K-T-A
C71	4030006880	S.CERAMIC	C1608 JB 1H 472K-T-A
C72	4030006860	S.CERAMIC	C1608 JB 1H 102K-T-A
C73	4030007010	S.CERAMIC	C1608 CH 1H 100D-T-A
C74	4030006860	S.CERAMIC	C1608 JB 1H 102K-T-A
C76	4030006860	S.CERAMIC	C1608 JB 1H 102K-T-A
C77	4030011600	S.CERAMIC	C1608 JB 1C 104KT-N
C79	4030006860	S.CERAMIC	C1608 JB 1H 102K-T-A
C80	4030007170	S.CERAMIC	C1608 CH 1H 221J-T-A
C81	4030011600	S.CERAMIC	C1608 JB 1C 104KT-N
C82	4030006860	S.CERAMIC	C1608 JB 1H 102K-T-A
C83	4030007010	S.CERAMIC	C1608 CH 1H 100D-T-A
C84	4030006880	S.CERAMIC	C1608 JB 1H 472K-T-A
C85	4030010760	S.CERAMIC	C1608 CH 1H 331J-T-A
C86	4030007080	S.CERAMIC	C1608 CH 1H 390J-T-A
C87	4030007100	S.CERAMIC	C1608 CH 1H 560J-T-A
C88	4030006850	S.CERAMIC	C1608 JB 1H 471K-T-A
C89	4030007150	S.CERAMIC	C1608 CH 1H 151J-T-A
C90	4030007040	S.CERAMIC	C1608 CH 1H 180J-T-A
C91	4030007010	S.CERAMIC	C1608 CH 1H 100D-T-A
C92	4030006860	S.CERAMIC	C1608 JB 1H 102K-T-A
C93	4030006860	S.CERAMIC	C1608 JB 1H 102K-T-A
C94	4030006860	S.CERAMIC	C1608 JB 1H 102K-T-A
C95	4030007010	S.CERAMIC	C1608 CH 1H 100D-T-A
C96	4030006860	S.CERAMIC	C1608 JB 1H 102K-T-A
C97	4030007010	S.CERAMIC	C1608 CH 1H 100D-T-A
C98	4030007090	S.CERAMIC	C1608 CH 1H 470J-T-A
C99	4030011600	S.CERAMIC	C1608 JB 1C 104KT-N
C100	4030011600	S.CERAMIC	C1608 JB 1C 104KT-N
C101	4030009350	S.CERAMIC	C1608 CH 1H 3R5B-T-A
C102	4030009350	S.CERAMIC	C1608 CH 1H 3R5B-T-A
C103	4030006860	S.CERAMIC	C1608 JB 1H 102K-T-A
C104	4030009540	S.CERAMIC	C1608 CH 1H 1R5B-T-A
C105	4030009540	S.CERAMIC	C1608 CH 1H 1R5B-T-A
C106	4030011600	S.CERAMIC	C1608 JB 1C 104KT-N
C111	4030006860	S.CERAMIC	C1608 JB 1H 102K-T-A
C112	4030006850	S.CERAMIC	C1608 JB 1H 471K-T-A
C114	4030006860	S.CERAMIC	C1608 JB 1H 102K-T-A
C121	4030007000	S.CERAMIC	C1608 CH 1H 090D-T-A
C122	4030009910	S.CERAMIC	C1608 CH 1H 040B-T-A
C123	4030007040	S.CERAMIC	C1608 CH 1H 180J-T-A
C124	4030011770	S.CERAMIC	C1608 CH 1H 060B-T-A
C125	4030007010	S.CERAMIC	C1608 CH 1H 100D-T-A
C130	4030007010	S.CERAMIC	C1608 CH 1H 100D-T-A
C131	4030006860	S.CERAMIC	C1608 JB 1H 102K-T-A
C132	4030006850	S.CERAMIC	C1608 JB 1H 471K-T-A
C133	4030009520	S.CERAMIC	C1608 CH 1H 020B-T-A
C134	4030006860	S.CERAMIC	C1608 JB 1H 102K-T-A
C135	4030006850	S.CERAMIC	C1608 JB 1H 471K-T-A
C136	4030006850	S.CERAMIC	C1608 JB 1H 471K-T-A
C137	4030007010	S.CERAMIC	C1608 CH 1H 100D-T-A
C138	4030006860	S.CERAMIC	C1608 JB 1H 102K-T-A
C140	4030011600	S.CERAMIC	C1608 JB 1C 104KT-N
C141	4030006850	S.CERAMIC	C1608 JB 1H 471K-T-A
C142	4030009520	S.CERAMIC	C1608 CH 1H 020B-T-A
C143	4030009510	S.CERAMIC	C1608 CH 1H 010B-T-A
C144	4030009510	S.CERAMIC	C1608 CH 1H 010B-T-A
C145	4030009520	S.CERAMIC	C1608 CH 1H 020B-T-A
C146	4030009500	S.CERAMIC	C1608 CH 1H 0R5B-T-A
C147	4030006850	S.CERAMIC	C1608 JB 1H 471K-T-A
C148	4030006880	S.CERAMIC	C1608 JB 1H 472K-T-A
C149	4030006860	S.CERAMIC	C1608 JB 1H 102K-T-A
C150	4030007010	S.CERAMIC	C1608 CH 1H 100D-T-A
C151	4030006850	S.CERAMIC	C1608 JB 1H 471K-T-A
C155	4030009560	S.CERAMIC	C1608 CH 1H R75B-T-A
C160	4030006860	S.CERAMIC	C1608 JB 1H 102K-T-A
C161	4030006860	S.CERAMIC	C1608 JB 1H 102K-T-A
C162	4030006860	S.CERAMIC	C1608 JB 1H 102K-T-A
C163	4030006860	S.CERAMIC	C1608 JB 1H 102K-T-A
C164	4510004630	S.ELECTROLYTIC	ECEV1CA100SR
C165	4030011600	S.CERAMIC	C1608 JB 1C 104KT-N
C166	4550006660	S.TANTALUM	ECST1CC226R
C167	4030011600	S.CERAMIC	C1608 JB 1C 104KT-N
C168	4030011600	S.CERAMIC	C1608 JB 1C 104KT-N
C169	4510004630	S.ELECTROLYTIC	ECEV1CA100SR
C170	4510004630	S.ELECTROLYTIC	ECEV1CA100SR
C171	4030006860	S.CERAMIC	C1608 JB 1H 102K-T-A
C172	4510004630	S.ELECTROLYTIC	ECEV1CA100SR

[MAIN UNIT] — UX-910

REF NO.	ORDER NO.	DESCRIPTION	
C173	4030006860	S.CERAMIC	C1608 JB 1H 102K-T-A
C174	4510004630	S.ELECTROLYTIC	ECEV1CA100SR
C175	4030006860	S.CERAMIC	C1608 JB 1H 102K-T-A
C176	4030011600	S.CERAMIC	C1608 JB 1C 104KT-N
C177	4030006860	S.CERAMIC	C1608 JB 1H 102K-T-A
C181	4030009530	S.CERAMIC	C1608 CH 1H 030B-T-A
C182	4030009500	S.CERAMIC	C1608 CH 1H 0R5B-T-A
C183	4030009920	S.CERAMIC	C1608 CH 1H 050B-T-A
C184	4030009510	S.CERAMIC	C1608 CH 1H 010B-T-A
C185	4030009530	S.CERAMIC	C1608 CH 1H 030B-T-A
C186	4030007010	S.CERAMIC	C1608 CH 1H 100D-T-A
C187	4030006860	S.CERAMIC	C1608 JB 1H 102K-T-A
C188	4030006880	S.CERAMIC	C1608 JB 1H 472K-T-A
C190	4030006860	S.CERAMIC	C1608 JB 1H 102K-T-A
C191	4030006860	S.CERAMIC	C1608 JB 1H 102K-T-A
C192	4030006860	S.CERAMIC	C1608 JB 1H 102K-T-A
C193	4030007010	S.CERAMIC	C1608 CH 1H 100D-T-A
C201	4030007020	S.CERAMIC	C1608 CH 1H 120J-T-A
C202	4030006940	S.CERAMIC	C1608 CH 1H 030C-T-A
C203	4030007050	S.CERAMIC	C1608 CH 1H 220J-T-A
C204	4030009510	S.CERAMIC	C1608 CH 1H 010B-T-A
C205	4030007030	S.CERAMIC	C1608 CH 1H 150J-T-A
C206	4030007010	S.CERAMIC	C1608 CH 1H 100D-T-A
C207	4030006860	S.CERAMIC	C1608 JB 1H 102K-T-A
C208	4030006880	S.CERAMIC	C1608 JB 1H 472K-T-A
C209	4030006860	S.CERAMIC	C1608 JB 1H 102K-T-A
C210	4030006860	S.CERAMIC	C1608 JB 1H 102K-T-A
C211	4030006860	S.CERAMIC	C1608 JB 1H 102K-T-A
C212	4030006860	S.CERAMIC	C1608 JB 1H 102K-T-A
C213	4030007010	S.CERAMIC	C1608 CH 1H 100D-T-A
C221	4030006880	S.CERAMIC	C1608 JB 1H 472K-T-A
C222	4030007170	S.CERAMIC	C1608 CH 1H 221J-T-A
C223	4030006850	S.CERAMIC	C1608 JB 1H 471K-T-A
C224	4030011600	S.CERAMIC	C1608 JB 1C 104KT-N
C225	4030007090	S.CERAMIC	C1608 CH 1H 470J-T-A
C226	4030007130	S.CERAMIC	C1608 CH 1H 101J-T-A
C227	4030006860	S.CERAMIC	C1608 JB 1H 102K-T-A
C228	4030007090	S.CERAMIC	C1608 CH 1H 470J-T-A
C229	4030009910	S.CERAMIC	C1608 CH 1H 040B-T-A
C230	4030006860	S.CERAMIC	C1608 JB 1H 102K-T-A
C232	4030006860	S.CERAMIC	C1608 JB 1H 102K-T-A
C240	4030007010	S.CERAMIC	C1608 CH 1H 100D-T-A
C241	4030009540	S.CERAMIC	C1608 CH 1H 1R5B-T-A
C242	4030009350	S.CERAMIC	C1608 CH 1H 3R5B-T-A
C243	4030009350	S.CERAMIC	C1608 CH 1H 3R5B-T-A
C244	4030009540	S.CERAMIC	C1608 CH 1H 1R5B-T-A
C245	4030007030	S.CERAMIC	C1608 CH 1H 150J-T-A
C246	4030006860	S.CERAMIC	C1608 JB 1H 102K-T-A
C247	4030007010	S.CERAMIC	C1608 CH 1H 100D-T-A
C248	4030011600	S.CERAMIC	C1608 JB 1C 104KT-N
C250	4030006850	S.CERAMIC	C1608 JB 1H 471K-T-A
C251	4030006860	S.CERAMIC	C1608 JB 1H 102K-T-A
C252	4030006860	S.CERAMIC	C1608 JB 1H 102K-T-A
C255	4030011600	S.CERAMIC	C1608 JB 1C 104KT-N
C256	4030006860	S.CERAMIC	C1608 JB 1H 102K-T-A
C257	4030011600	S.CERAMIC	C1608 JB 1C 104KT-N
C258	4030007130	S.CERAMIC	C1608 CH 1H 101J-T-A
C259	4030006860	S.CERAMIC	C1608 JB 1H 102K-T-A
C260	4030006860	S.CERAMIC	C1608 JB 1H 102K-T-A
C261	4030006860	S.CERAMIC	C1608 JB 1H 102K-T-A
C262	4030007010	S.CERAMIC	C1608 CH 1H 100D-T-A
C263	4030006860	S.CERAMIC	C1608 JB 1H 102K-T-A
C264	4030007010	S.CERAMIC	C1608 CH 1H 100D-T-A
C265	4030006860	S.CERAMIC	C1608 JB 1H 102K-T-A
C266	4030007010	S.CERAMIC	C1608 CH 1H 100D-T-A
C267	4030006860	S.CERAMIC	C1608 JB 1H 102K-T-A
C268	4030007010	S.CERAMIC	C1608 CH 1H 100D-T-A
C271	4030009520	S.CERAMIC	C1608 CH 1H 020B-T-A
C273	4030009550	S.CERAMIC	C1608 CH 1H 2R5B-T-A
C274	4030006860	S.CERAMIC	C1608 JB 1H 102K-T-A
C275	4030006860	S.CERAMIC	C1608 JB 1H 102K-T-A
C276	4030006850	S.CERAMIC	C1608 JB 1H 471K-T-A
C277	4030006850	S.CERAMIC	C1608 JB 1H 471K-T-A
C278	4030006860	S.CERAMIC	C1608 JB 1H 102K-T-A
C279	4030009550	S.CERAMIC	C1608 CH 1H 2R5B-T-A
C280	4030006880	S.CERAMIC	C1608 JB 1H 472K-T-A
C281	4030006880	S.CERAMIC	C1608 JB 1H 472K-T-A
C282	4510004630	S.ELECTROLYTIC	ECEV1CA100SR
C283	4030006860	S.CERAMIC	C1608 JB 1H 102K-T-A
C284	4030006850	S.CERAMIC	C1608 JB 1H 471K-T-A
C285	4030006860	S.CERAMIC	C1608 JB 1H 102K-T-A
C286	4030011600	S.CERAMIC	C1608 JB 1C 104KT-N

S.=Surface mount

[MAIN UNIT] — UX-910

REF NO.	ORDER NO.	DESCRIPTION
C287	4030006880	S.CERAMIC C1608 JB 1H 472K-T-A
C288	4030009530	S.CERAMIC C1608 CH 1H 030B-T-A
C289	4030007090	S.CERAMIC C1608 CH 1H 470J-T-A
C290	4030007090	S.CERAMIC C1608 CH 1H 470J-T-A
C292	4030006860	S.CERAMIC C1608 JB 1H 102K-T-A
C293	4030006860	S.CERAMIC C1608 JB 1H 102K-T-A
C294	4030006880	S.CERAMIC C1608 JB 1H 472K-T-A
C295	4030006880	S.CERAMIC C1608 JB 1H 472K-T-A
C297	4030009520	S.CERAMIC C1608 CH 1H 020B-T-A
C298	4030009540	S.CERAMIC C1608 CH 1H 1R5B-T-A
C299	4030009550	S.CERAMIC C1608 CH 1H 2R5B-T-A
C300	4030009550	S.CERAMIC C1608 CH 1H 2R5B-T-A
C301	4030009540	S.CERAMIC C1608 CH 1H 1R5B-T-A
C302	4030006880	S.CERAMIC C1608 JB 1H 472K-T-A
C304	4030006860	S.CERAMIC C1608 JB 1H 102K-T-A
C305	4030007090	S.CERAMIC C1608 CH 1H 470J-T-A
C306	4030007010	S.CERAMIC C1608 CH 1H 100D-T-A
C310	4030006860	S.CERAMIC C1608 JB 1H 102K-T-A
C311	4030006860	S.CERAMIC C1608 JB 1H 102K-T-A
C312	4030006860	S.CERAMIC C1608 JB 1H 102K-T-A
C313	4030006860	S.CERAMIC C1608 JB 1H 102K-T-A
C314	4030006860	S.CERAMIC C1608 JB 1H 102K-T-A
C315	4030006860	S.CERAMIC C1608 JB 1H 102K-T-A
C316	4030006860	S.CERAMIC C1608 JB 1H 102K-T-A
C317	4030006860	S.CERAMIC C1608 JB 1H 102K-T-A
C318	4030006860	S.CERAMIC C1608 JB 1H 102K-T-A
C320	4030009920	S.CERAMIC C1608 CH 1H 050B-T-A
C321	4030007010	S.CERAMIC C1608 CH 1H 100D-T-A
C322	4030007090	S.CERAMIC C1608 CH 1H 470J-T-A
C323	4030007130	S.CERAMIC C1608 CH 1H 101J-T-A
C324	4030007010	S.CERAMIC C1608 CH 1H 100D-T-A
C325	4030007090	S.CERAMIC C1608 CH 1H 470J-T-A
C326	4030007090	S.CERAMIC C1608 CH 1H 470J-T-A
C327	4030007130	S.CERAMIC C1608 CH 1H 101J-T-A
C328	4030007010	S.CERAMIC C1608 CH 1H 100D-T-A
C329	4030007090	S.CERAMIC C1608 CH 1H 470J-T-A
C330	4030007130	S.CERAMIC C1608 CH 1H 101J-T-A
C331	4030007010	S.CERAMIC C1608 CH 1H 100D-T-A
C332	4610001190	S.TRIMMER ECR-JA003 A11W
C333	4030007010	S.CERAMIC C1608 CH 1H 100D-T-A
C334	4030007010	S.CERAMIC C1608 CH 1H 100D-T-A
C335	4030007010	S.CERAMIC C1608 CH 1H 100D-T-A
C336	4030006860	S.CERAMIC C1608 JB 1H 102K-T-A
C337	4030006860	S.CERAMIC C1608 JB 1H 102K-T-A
C501	4030006850	S.CERAMIC C1608 JB 1H 471K-T-A
C502	4030006850	S.CERAMIC C1608 JB 1H 471K-T-A
C503	4550006350	S.TANTALUM TEMSVB2 1A 226M-8L
C504	4030006880	S.CERAMIC C1608 JB 1H 472K-T-A
C505	4030006860	S.CERAMIC C1608 JB 1H 102K-T-A
C506	4030007010	S.CERAMIC C1608 CH 1H 100D-T-A
C507	4030011600	S.CERAMIC C1608 JB 1C 104KT-N
C508	4030006850	S.CERAMIC C1608 JB 1H 471K-T-A
C509	4030011600	S.CERAMIC C1608 JB 1C 104KT-N
C510	4340000020	S.MYLAR ECWU 1C 333JB5
C511	4030006860	S.CERAMIC C1608 JB 1H 102K-T-A
C512	4550006360	S.TANTALUM ECST1VY104R
C513	4550006360	S.TANTALUM ECST1VY104R
C514	4030006880	S.CERAMIC C1608 JB 1H 472K-T-A
C515	4030006850	S.CERAMIC C1608 JB 1H 471K-T-A
C516	4550003220	S.TANTALUM TEMSVA 1E 105M-8L
C517	4550003220	S.TANTALUM TEMSVA 1E 105M-8L
C518	4550006170	S.TANTALUM ECST1AY225R
C520	4030006860	S.CERAMIC C1608 JB 1H 102K-T-A
C522	4030011600	S.CERAMIC C1608 JB 1C 104KT-N
C523	4030006850	S.CERAMIC C1608 JB 1H 471K-T-A
C524	4550003220	S.TANTALUM TEMSVA 1E 105M-8L
C531	4510005940	ELECTROLYTIC 10 MV 470 HC
C532	4030010210	S.CERAMIC C3216 JB 1C 105M-T-A
C533	4550003220	S.TANTALUM TEMSVA 1E 105M-8L
C534	4030006850	S.CERAMIC C1608 JB 1H 471K-T-A
C535	4030011600	S.CERAMIC C1608 JB 1C 104KT-N
C536	4030006860	S.CERAMIC C1608 JB 1H 102K-T-A
C537	4030007090	S.CERAMIC C1608 CH 1H 470J-T-A
C538	4030006860	S.CERAMIC C1608 JB 1H 102K-T-A
C541	4030011770	S.CERAMIC C1608 CH 1H 060B-T-A
C542	4030009500	S.CERAMIC C1608 CH 1H 0R5B-T-A
C543	4030009540	S.CERAMIC C1608 CH 1H 1R5B-T-A
C544	4030009540	S.CERAMIC C1608 CH 1H 1R5B-T-A
C545	4030006860	S.CERAMIC C1608 JB 1H 102K-T-A
C546	4030009500	S.CERAMIC C1608 CH 1H 0R5B-T-A
C548	4030007010	S.CERAMIC C1608 CH 1H 100D-T-A
C549	4030006860	S.CERAMIC C1608 JB 1H 102K-T-A

[MAIN UNIT] — UX-910

REF NO.	ORDER NO.	DESCRIPTION
C550	4030007010	S.CERAMIC C1608 CH 1H 100D-T-A
C551	4030007090	S.CERAMIC C1608 CH 1H 470J-T-A
C552	4030007090	S.CERAMIC C1608 CH 1H 470J-T-A
C561	4030007050	S.CERAMIC C1608 CH 1H 220J-T-A
C562	4030007050	S.CERAMIC C1608 CH 1H 220J-T-A
C563	4030007050	S.CERAMIC C1608 CH 1H 220J-T-A
C564	4030007050	S.CERAMIC C1608 CH 1H 220J-T-A
C571	4030009920	S.CERAMIC C1608 CH 1H 050B-T-A
C572	4030007020	S.CERAMIC C1608 CH 1H 120J-T-A
C573	4030009520	S.CERAMIC C1608 CH 1H 020B-T-A
C574	4030007070	S.CERAMIC C1608 CH 1H 330J-T-A
C575	4030009530	S.CERAMIC C1608 CH 1H 030B-T-A
C581	4030009550	S.CERAMIC C1608 CH 1H 2R5B-T-A
C582	4030009510	S.CERAMIC C1608 CH 1H 010B-T-A
C583	4030009520	S.CERAMIC C1608 CH 1H 020B-T-A
C584	4030009570	S.CERAMIC C1608 CH 1H 0R3B-T-A
C585	4030009530	S.CERAMIC C1608 CH 1H 030B-T-A
C603	4030007130	S.CERAMIC C1608 CH 1H 101J-T-A
C604	4030007140	S.CERAMIC C1608 CH 1H 121J-T-A
C605	4030006880	S.CERAMIC C1608 JB 1H 472K-T-A
C606	4030006880	S.CERAMIC C1608 JB 1H 472K-T-A
C607	4030012600	S.CERAMIC C2012 JB 1A 105M-T-A
C608	4030011600	S.CERAMIC C1608 JB 1C 104KT-N
C609	4030011600	S.CERAMIC C1608 JB 1C 104KT-N
C610	4030007170	S.CERAMIC C1608 CH 1H 221J-T-A
C611	4030011280	S.CERAMIC C1608 CH 1H 271J-T-A
C612	4030007120	S.CERAMIC C1608 CH 1H 820J-T-A
C613	4030006880	S.CERAMIC C1608 JB 1H 472K-T-A
C614	4030006860	S.CERAMIC C1608 CH 1H 102K-T-A
C621	4030011600	S.CERAMIC C1608 JB 1C 104KT-N
C622	4030011600	S.CERAMIC C1608 JB 1C 104KT-N
C623	4030006860	S.CERAMIC C1608 JB 1H 102K-T-A
C624	4030012600	S.CERAMIC C2012 JB 1A 105M-T-A
C641	4030009920	S.CERAMIC C1608 CH 1H 050B-T-A
C642	4030009550	S.CERAMIC C1608 CH 1H 2R5B-T-A
C643	4030009910	S.CERAMIC C1608 CH 1H 040B-T-A
C644	4030007050	S.CERAMIC C1608 CH 1H 220J-T-A
C645	4030007110	S.CERAMIC C1608 CH 1H 680J-T-A
C651	4030007090	S.CERAMIC C1608 CH 1H 470J-T-A
C652	4030009990	S.CERAMIC C1608 CH 1H 200J-T-A
C653	4030007110	S.CERAMIC C1608 CH 1H 680J-T-A
C654	4030007010	S.CERAMIC C1608 CH 1H 100D-T-A
C655	4030007120	S.CERAMIC C1608 CH 1H 820J-T-A
C656	4030009350	S.CERAMIC C1608 CH 1H 3R5B-T-A
C657	4030007100	S.CERAMIC C1608 CH 1H 560J-T-A
C661	4030006860	S.CERAMIC C1608 JB 1H 102K-T-A
C662	4030006860	S.CERAMIC C1608 JB 1H 102K-T-A
C663	4030006860	S.CERAMIC C1608 JB 1H 102K-T-A
C664	4030011600	S.CERAMIC C1608 JB 1C 104KT-N
C665	4030006860	S.CERAMIC C1608 JB 1H 102K-T-A
C666	4030006860	S.CERAMIC C1608 JB 1H 102K-T-A
C667	4030006860	S.CERAMIC C1608 JB 1H 102K-T-A
C668	4030006860	S.CERAMIC C1608 JB 1H 102K-T-A
C669	4030011600	S.CERAMIC C1608 JB 1C 104KT-N
C670	4030006860	S.CERAMIC C1608 JB 1H 102K-T-A
C671	4030011600	S.CERAMIC C1608 JB 1C 104KT-N
C672	4030006860	S.CERAMIC C1608 JB 1H 102K-T-A
C673	4030006860	S.CERAMIC C1608 JB 1H 102K-T-A
C674	4030006860	S.CERAMIC C1608 JB 1H 102K-T-A
C675	4510004630	S.ELECTROLYTIC ECEV1CA100SR
C676	4030011600	S.CERAMIC C1608 JB 1C 104KT-N
C677	4030011600	S.CERAMIC C1608 JB 1C 104KT-N
C678	4030006860	S.CERAMIC C1608 JB 1H 102K-T-A
C679	4030011600	S.CERAMIC C1608 JB 1C 104KT-N
C680	4510007130	S.ELECTROLYTIC EEFCOJ 470R
C685	4030006860	S.CERAMIC C1608 JB 1H 102K-T-A
C686	4030007090	S.CERAMIC C1608 CH 1H 470J-T-A
C687	4030006850	S.CERAMIC C1608 JB 1H 471K-T-A
C688	4030007010	S.CERAMIC C1608 CH 1H 100D-T-A
C689	4030011600	S.CERAMIC C1608 JB 1C 104KT-N
C702	4030006850	S.CERAMIC C1608 JB 1H 471K-T-A
C704	4030006860	S.CERAMIC C1608 JB 1H 102K-T-A
C705	4510004630	S.ELECTROLYTIC ECEV1CA100SR
C706	4550006300	S.TANTALUM ECST1AY475R
C707	4550006300	S.TANTALUM ECST1AY475R
C708	4550006170	S.TANTALUM ECST1AY225R
C709	4030006850	S.CERAMIC C1608 JB 1H 471K-T-A
C710	4030006860	S.CERAMIC C1608 JB 1H 102K-T-A
C711	4550006080	S.TANTALUM TEMSVB2 1C 106M-8L
C712	4030006860	S.CERAMIC C1608 JB 1H 102K-T-A
C713	4030006860	S.CERAMIC C1608 JB 1H 102K-T-A
C715	4030006860	S.CERAMIC C1608 JB 1H 102K-T-A

S.=Surface mount

[MAIN UNIT] — UX-910

REF NO.	ORDER NO.	DESCRIPTION	
C731	4030007050	S.CERAMIC	C1608 CH 1H 220J-T-A
C732	4030007050	S.CERAMIC	C1608 CH 1H 220J-T-A
C733	4030009520	S.CERAMIC	C1608 CH 1H 020B-T-A
C734	4030011600	S.CERAMIC	C1608 JB 1C 104KT-N
C735	4030006860	S.CERAMIC	C1608 JB 1H 102K-T-A
C741	4030006860	S.CERAMIC	C1608 JB 1H 102K-T-A
C742	4030007020	S.CERAMIC	C1608 CH 1H 120J-T-A
C743	4030011600	S.CERAMIC	C1608 JB 1C 104KT-N
C744	4030006860	S.CERAMIC	C1608 JB 1H 102K-T-A
C746	4550006080	S.TANTALUM	TEMSVB2 1C 106M-8L
C747	4030007020	S.CERAMIC	C1608 CH 1H 120J-T-A
C748	4030009550	S.CERAMIC	C1608 CH 1H 2R5B-T-A
C749	4030007020	S.CERAMIC	C1608 CH 1H 120J-T-A
C750	4030006880	S.CERAMIC	C1608 JB 1H 472K-T-A
C751	4030007050	S.CERAMIC	C1608 CH 1H 220J-T-A
C752	4030007050	S.CERAMIC	C1608 CH 1H 220J-T-A
C753	4030009520	S.CERAMIC	C1608 CH 1H 020B-T-A
C754	4550006770	S.TANTALUM	TEMSVD2 1C 476M-12R
C755	4550003220	S.TANTALUM	TEMSVA 1E 105M-8L
C756	4030006860	S.CERAMIC	C1608 JB 1H 102K-T-A
C761	4030006860	S.CERAMIC	C1608 JB 1H 102K-T-A
C762	4030006860	S.CERAMIC	C1608 JB 1H 102K-T-A
C763	4030006860	S.CERAMIC	C1608 JB 1H 102K-T-A
C764	4030011600	S.CERAMIC	C1608 JB 1C 104KT-N
C765	4030006860	S.CERAMIC	C1608 JB 1H 102K-T-A
C766	4030006860	S.CERAMIC	C1608 JB 1H 102K-T-A
C767	4030006860	S.CERAMIC	C1608 JB 1H 102K-T-A
C769	4030011600	S.CERAMIC	C1608 JB 1C 104KT-N
C770	4030006850	S.CERAMIC	C1608 JB 1H 471K-T-A
C771	4030006850	S.CERAMIC	C1608 JB 1H 471K-T-A
C772	4030006860	S.CERAMIC	C1608 JB 1H 102K-T-A
C773	4030011600	S.CERAMIC	C1608 JB 1C 104KT-N
C774	4030006860	S.CERAMIC	C1608 JB 1H 102K-T-A
C775	4030006860	S.CERAMIC	C1608 JB 1H 102K-T-A
C776	4030006860	S.CERAMIC	C1608 JB 1H 102K-T-A
C777	4030006860	S.CERAMIC	C1608 JB 1H 102K-T-A
C778	4030006860	S.CERAMIC	C1608 JB 1H 102K-T-A
RL51	6330000810	RELAY	ARK115
J311	6510022280	CONNECTOT	25FMN-BTK
W5	7030003860	S.JUMPER	ERJ3GE JPW V
W10	7030008240	S.JUMPER	ERJ12YJ0R00U
W11	7030008240	S.JUMPER	ERJ12YJ0R00U
W12	7030008240	S.JUMPER	ERJ12YJ0R00U
W13	7030000010	S.JUMPER	MCR10EZHJ JPW (000)
W14	7030008240	S.JUMPER	ERJ12YJ0R00U
W15	7030008240	S.JUMPER	ERJ12YJ0R00U
W16	7030000010	S.JUMPER	MCR10EZHJ JPW (000)
W17	7030008240	S.JUMPER	ERJ12YJ0R00U
W18	7030008240	S.JUMPER	ERJ12YJ0R00U
W19	7030008240	S.JUMPER	ERJ12YJ0R00U
W20	7030010250	S.JUMPER	ERJ1TYJ 0R00U
W21	7030008240	S.JUMPER	ERJ12YJ0R00U
W22	7030000010	S.JUMPER	MCR10EZHJ JPW (000)
W23	7030008240	S.JUMPER	ERJ12YJ0R00U
W31	8900010412	CABLE	OPC-991B
W32	7120000490	JUMPER	ERD25T0
W51	7120000490	JUMPER	ERD25T0
W52	7120000490	JUMPER	ERD25T0
W63	7030003860	S.JUMPER	ERJ3GE JPW V
W142	7030003860	S.JUMPER	ERJ3GE JPW V
W182	7030003860	S.JUMPER	ERJ3GE JPW V
W202	7030003860	S.JUMPER	ERJ3GE JPW V
W223	7030003860	S.JUMPER	ERJ3GE JPW V
W241	7030008240	S.JUMPER	ERJ12YJ0R00U
W242	7030008240	S.JUMPER	ERJ12YJ0R00U
W281	7120000470	JUMPER	ERDS2T0
W290	7120000470	JUMPER	ERDS2T0
W311	7030003860	S.JUMPER	ERJ3GE JPW V
W531	7030008240	S.JUMPER	ERJ12YJ0R00U
W532	7030008240	S.JUMPER	ERJ12YJ0R00U
W601	7030000010	S.JUMPER	MCR10EZHJ JPW (000)
W731	7030003860	S.JUMPER	ERJ3GE JPW V
WS1	8970023850	E.OTHER	EX2356 1.5D COAXIAL TUBE (1)/MA

[MAIN UNIT] — UX-910

REF NO.	ORDER NO.	DESCRIPTION	
EP1	0910052786	PCB	B 5468F
EP10	6910000970	BEAD	DL-20P 2.6-3-1.2H
EP11	6910000970	BEAD	DL-20P 2.6-3-1.2H
EP12	6910000970	BEAD	DL-20P 2.6-3-1.2H
EP312	6910000630	BEAD	FSOH070RN
EP313	9010001410	TUBE	TUBE 8.0 (d)
EP510	6910012350	S.BEAD	MMZ1608Y 102BT
EP543	6910012350	S.BEAD	MMZ1608Y 102BT
EP610	6910012350	S.BEAD	MMZ1608Y 102BT

S.=Surface mount

SECTION 7 MECHANICAL PARTS

[FRONT UNIT]

REF. NO.	ORDER NO.	DESCRIPTION	QTY.
EP1	6910012480	RMS20-250-201-1R	1
EP2	6450001230	HLJ0999-01-480	1
MP1	8210017280	2355 front panel assembly	1
MP2	8310048750	2355 window plate	1
MP4	8930053620	2355 A-power key	1
MP5	8930052170	2355 FUNC key	1
MP6	8930052180	2355 key board	1
MP7	8010018220	2355 sub chassis assembly	1
MP9	8610010970	Knob N283 assembly	1
MP13	8930049370	2240 brake sheet	1
MP14	8930052200	2355 brake plate	1
MP15	8930014030	610 brake pat	1
MP17	8610010260	Knob N252	1
MP19	8610010880	Knob N273 (B)	1
MP20	8610010260	Knob N252	1
MP22	8610010880	Knob N273 (B)	1
MP23	8610010260	Knob N252	1
MP25	8610010880	Knob N273 (B)	1
MP31	8810009130	Screw PH BT M3 X 12 NI-ZU	1
MP32	8810008660	Screw PH BT M3 X 8 NI-ZU	2
MP33	8810008630	Screw PH BT M3 X 6 NI-ZU	1
MP34	8810008630	Screw PH BT M3 X 6 NI-ZU	7
MP35	8810009560	Screw PH BT M2 X 6 ZK	2
MP36	8820000770	1296 screw	1
MP38	8930054510	Rubber sheet (AW)	1

[DISPLAY UNIT]

REF. NO.	ORDER NO.	DESCRIPTION	QTY.
DS31	5030001840	LCD A0095	1
EP31	8930052490	LCD contact SRCN-2355-SP-N-W	2
MP1	8210016870	2355 reflector	1
MP2	8930052230	2355 LCD filter	1
MP3	8930052221	2355 LCD holder-1	1
MP4	8930049930	Sheet CC	2
MP801*	8510013290	2355 DC case	1
MP802	8510013280	2355 DC cover	1

[VR-A BOARD]

REF. NO.	ORDER NO.	DESCRIPTION	QTY.
R1	7210002970	Variable register RV-314	1

[VR-B BOARD]

REF. NO.	ORDER NO.	DESCRIPTION	QTY.
R1	7210002970	Variable register RV-314	1

[RIT BOARD]

REF. NO.	ORDER NO.	DESCRIPTION	QTY.
R1	7210003090	Variable register RV-316	1

[JACK BOARD]

REF. NO.	ORDER NO.	DESCRIPTION	QTY.
J1	6450001250	Connector HLJ4306-01-3070	1

[MIC BOARD]

REF. NO.	ORDER NO.	DESCRIPTION	QTY.
J1	6510000190	Connector FM214-8SS	1

[COVER PARTS]

REF. NO.	ORDER NO.	DESCRIPTION	QTY.
SP1	2510000040	Speaker C065K12I0810	1
MP1	8110007190	2355 L-cover	1
MP2	8110007310	2355 U-cover assembly	1
MP5	8930006390	Speaker holder	1
MP6	8930005790	Collar foot (A)	1
MP7	8930005800	Collar foot (B)	1
MP8	8010001520	Stand (C)	1
MP9	8930002900	Rubber foot (A)	2
MP10	8930007120	Sheet B	2
MP21	8810009030	Screw FH M3 X 8 ZK	4
MP22	8810008660	Screw PH BT M3 X 8 NI-ZU	2
MP23	8810008660	Screw PH BT M3 X 8 NI-ZU	2
MP24	8810009130	Screw PH BT M3 X 12 NI-ZU	2
MP25	8810005770	Screw BiH M3 X 8 ZK	14
MP33	8930052550	2241 sheet	2
MP34	8930047900	Cushion sheet (G)	1
MP35	8930054520	Shield sponge (E)	1

[CHASSIS PARTS]

REF. NO.	ORDER NO.	DESCRIPTION	QTY.
J1	6510000370	Connector MR-DS	1
J2	6510000330	Connector NR-DS	1
MF1	2710000690	Fan AFB0812HHB	1
MP1	8010018180	2355 chassis	1
MP2	8510012990	2355 pa cover	1
MP3	8510013600	2355 A-PLL cover	1
MP5	8930053920	2355 fan holder	1
MP6	8930049610	2240 unit holder	2
MP9	8930052450	2355 earth spring	1
MP10	8930052450	2355 earth spring	1
MP12	8930048520	2156 clip	1
MP13	8930030770	1428 clip	1
MP31	8810008660	Screw PH BT M3 X 8 NI-ZU	14
MP32	8810008660	Screw PH BT M3 X 8 NI-ZU	6
MP33	8810008660	Screw PH BT M3 X 8 NI-ZU	5
MP34	8810008660	Screw PH BT M3 X 8 NI-ZU	8
MP35	8810008660	Screw PH BT M3 X 8 NI-ZU	6
MP36	8810008660	Screw PH BT M3 X 8 NI-ZU	2
MP37	8810009650	Screw FH BT M3 X 8 NI-ZU	4
MP38	8810003960	Setscrew A M2.6 X 5	4
MP39	8810000420	Screw PH M4 X 18	4
MP40	8810008660	Screw PH BT M3 X 8 NI-ZU	2
MP41	8810008660	Screw PH BT M3 X 8 NI-ZU	2
MP42	8820000530	Bolt M4 X 8 NI	1
MP43	8850000140	Flat washer M4 NI BS	2
MP44	8850000430	Spring washer M4 NI	1
MP45	8810009040	Setscrew H M2.6 X 10 NI	2
MP46	8810009040	Setscrew H M2.6 X 10 NI	2
MP47	8810009040	Setscrew H M2.6 X 10 NI	2
MP48	8810009040	Setscrew H M2.6 X 10 NI	2
MP49	8810009040	Setscrew H M2.6 X 10 NI	2
MP50	8810009040	Setscrew H M2.6 X 10 NI	1
MP51	8810003170	Setscrew A M3 X 8	1
MP52	8310050190	2355 ANT plate	1
MP53	8310050180	2355 D-SUB plate	1
MP54	8930041830	Sponge (ER)	1
MP55	8930001170	Earth spring (A)	1
MP56	8930031760	Rubber sheet (N)	5
MP57	8930005450	Insulation sheet (F)	1
MP58	8930049770	Sponge (GF)	2
MP59	8930054520	Shield sponge (E)	1
MP60	8930027890	946 earth spring	1
MP61	8930001450	Sponge (P)	1

* Refer to Section 9 BOARD LAYOUTS.

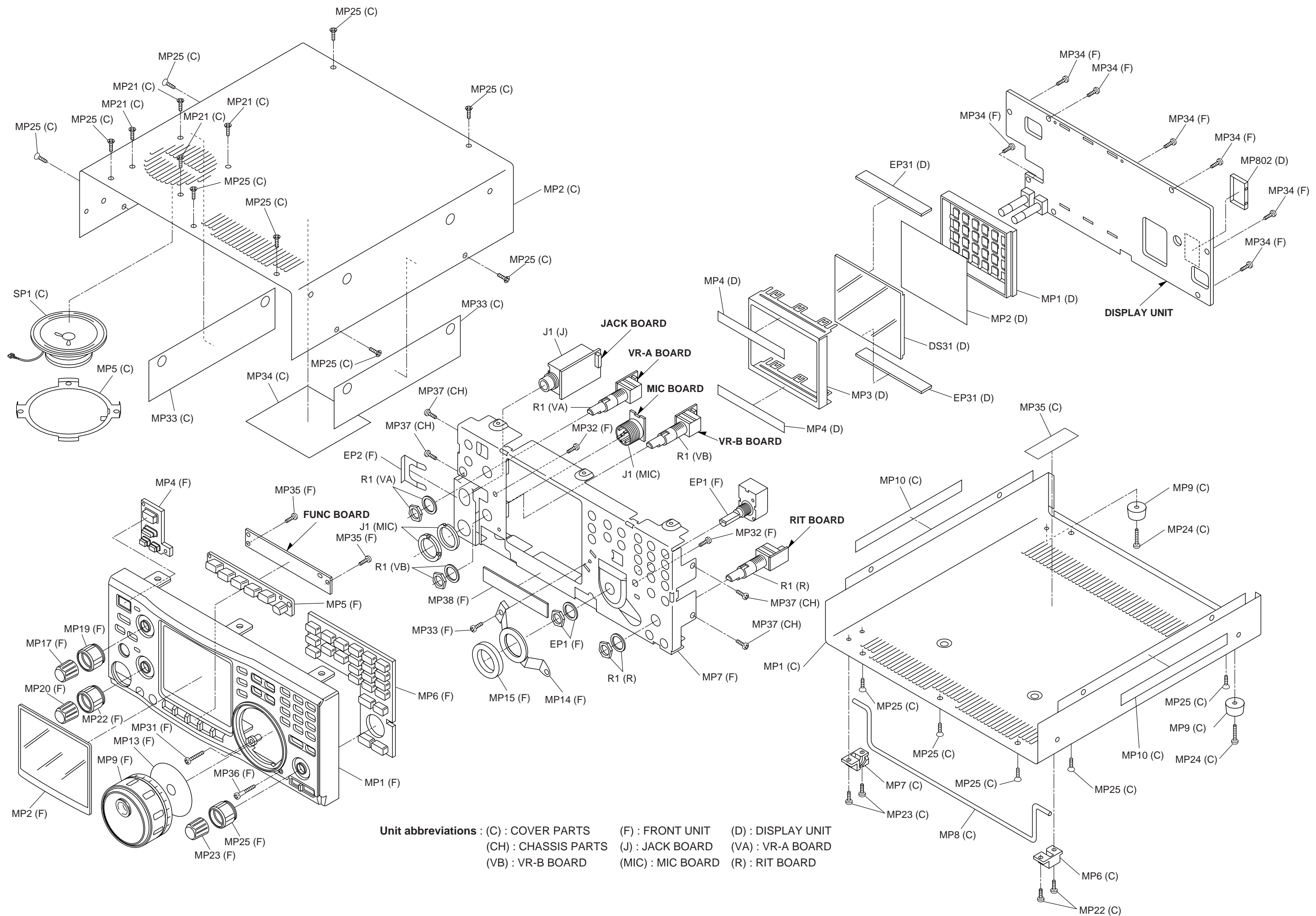

Unit abbreviations : (C) : COVER PARTS (F) : FRONT UNIT (D) : DISPLAY UNIT
(CH) : CHASSIS PARTS (J) : JACK BOARD (VA) : VR-A BOARD
(VB) : VR-B BOARD (MIC) : MIC BOARD (R) : RIT BOARD

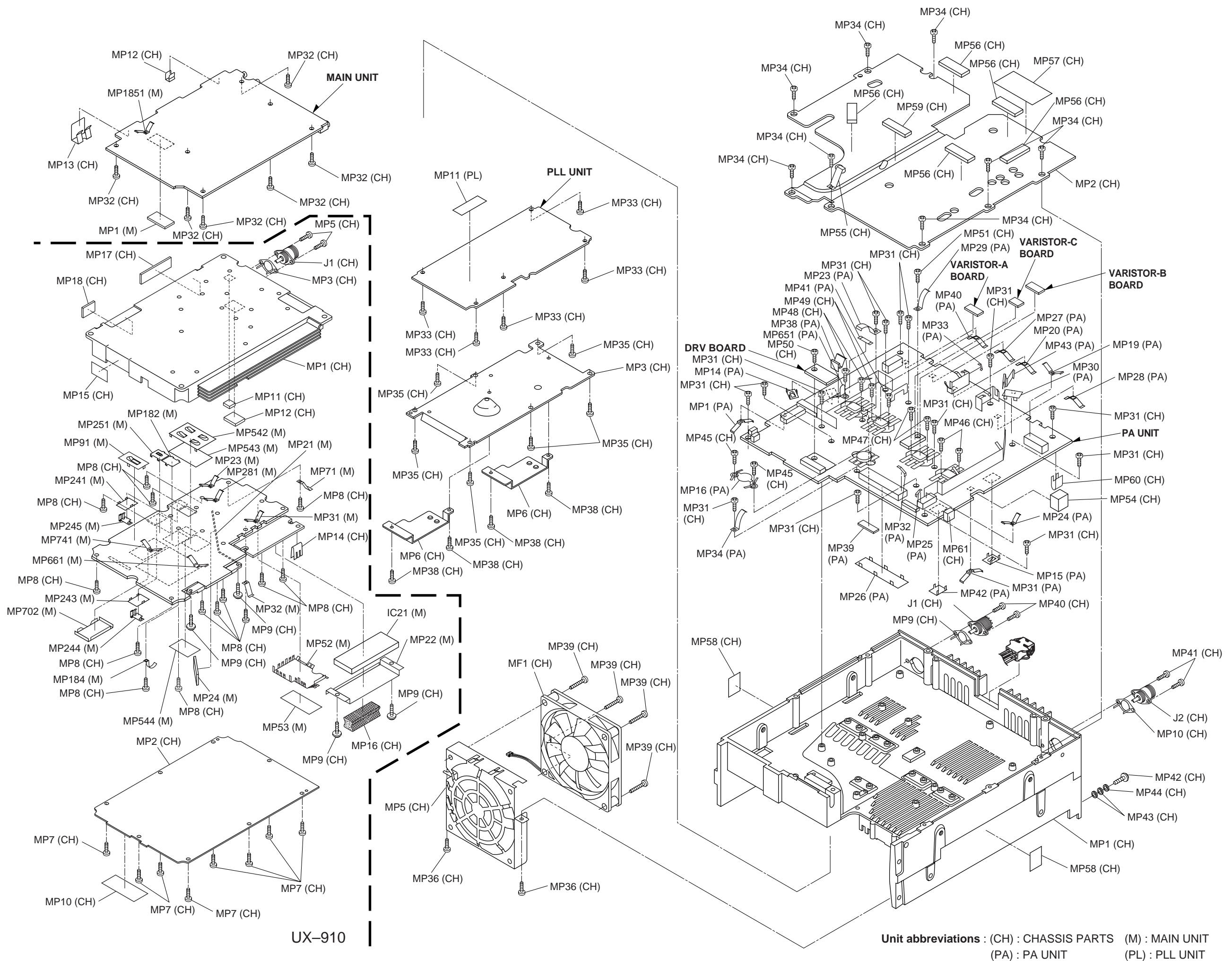

[PA UNIT]

REF. NO.	ORDER NO.	DESCRIPTION	QTY.
MP1	8930014140	Earth spring (D)	1
MP7*	8510012310	2157 DBM case	1
MP8*	8510013620	2355 A-filter case	1
MP9*	8510002020	MIX shield case	1
MP10*	8510012310	2157 DBM case	1
MP11*	8510013390	2355 MIX case	1
MP12*	8510013890	2355 V-A shield plate	1
MP13*	8510013630	2355 U-A shield plate	1
MP14	8510010460	1691 main shield plate	1
MP15	8510010460	1691 main shield plate	1
MP16	8860001130	2177 rug	1
MP17*	8510002020	MIX shield case	1
MP19	8930054530	2355 earth spring	1
MP20	8930014140	Earth spring (D)	1
MP21*	8510013560	2355 U-L plate	1
MP22*	8510013680	2355 U-R plate	1
MP23	8930017190	Earth spring (F)	1
MP24	8930054530	2355 earth spring	1
MP25	8930017200	752 earth spring	1
MP26	8510004650	505 shield palte	1
MP27	8930014140	Earth spring (D)	1
MP28	8930014140	Earth spring (D)	1
MP29	8930017190	Earth spring (F)	1
MP30	8510002280	VCO shield plate (A)	1
MP31	8930014140	Earth spring (D)	1
MP32	8930017200	752 earth spring	1
MP33	8930017200	752 earth spring	1
MP34	8930017190	Earth spring (F)	1
MP38	8930006930	365 earth spring	1
MP39	8930050150	Thermally sheet (K)	1
MP40	8930014140	Earth spring (D)	1
MP41*	8930024170	Earth spring (G)	1
MP42	8510002280	VCO shield plate (A)	1
MP43	8930006930	365 earth spring	1
MP300	8950000180	Cable tie -80	1
MP301	8950000180	Cable tie -80	1
MP501*	8510012310	2157 DBM case	1
MP502*	8510012310	2157 DBM case	1
MP511*	8510002020	MIX shield case	1
MP651	8860000100	Earth rug B2 (M2.6) AG BS	1

[PLL UNIT]

REF. NO.	ORDER NO.	DESCRIPTION	QTY.
MP1*	8510013510	2355 VCO case	1
MP2*	8510013510	2355 VCO case	1
MP7*	8510011160	1897 PLL shield case	1
MP8*	8510010850	1897 D/A case	1
MP9*	8510011160	1897 PLL shield case	1
MP10*	8510010850	1897 D/A case	1
MP11	8930043110	Rubber sheet (AD)	1

[MAIN UNIT]

REF. NO.	ORDER NO.	DESCRIPTION	QTY.
MP1	8930041830	Sponge (ER)	1
MP1851	8930014140	Earth spring (D)	1

[DRV BOARD]

REF. NO.	ORDER NO.	DESCRIPTION	QTY.
MP1	8410002390	2355 PA heatsink	1

[UNPACKING]

REF. NO.	ORDER NO.	DESCRIPTION	QTY.
F1	5210000090	Fuse FGB 30A	2
F2	5210000130	Fuse FGB 4A	1
W1	8900009960	Cable OPC-657A	1
MC1	7700000600	Microphone HM-12	1

[UX-910 CHASSIS PARTS]

REF. NO.	ORDER NO.	DESCRIPTION	QTY.
J1	6510000330	Connector NR-DS	1
MP1	8010018161	2356 case-1	1
MP2	8110007260	2356 cover	1
MP3	8930052450	2355 earth plate	1
MP5	8810008660	PH BT M3 X 8 NI-ZU	2
MP7	8810008660	PH BT M3 X 8 NI-ZU	8
MP8	8810008660	PH BT M3 X 8 NI-ZU	14
MP9	8810007230	Setscrew H M3 X 8	4
MP10	8310049280	Serial No seal UX-910	1
MP11	8930053470	Thermmaly sheet (R)	1
MP12	8930053930	Thermmaly sheet (S)	1
MP14	8930001180	Earth holder	1
MP15	8930054190	Two sided tape (AB)	1
MP16	8930054520	Shield sponge (E)	1
MP17	8930054980	Ferrite sheet (L)	1
MP18	8930030380	Ferrite sheet (C)	1

[UX-910 MAIN UNIT]

REF. NO.	ORDER NO.	DESCRIPTION	QTY.
MP21x	8510013610	2356 plate	1
MP22	8930011460	566 PA module holder	1
MP23	8930014140	Earth spring (D)	1
MP24	8930054820	Ferrite sheet (K)	1
MP31	8930014140	Earth spring (D)	1
MP32	8930001170	Earth spring (A)	1
MP51*	8510013300	2356 shield plate	1
MP52	8510013310	2356 shield cover	1
MP53	8930054470	Ferrite sheet (I)	1
MP71	8930001170	Earth spring (A)	1
MP81*	8510012400	2177 D/A case	1
MP91	8510013820	2356 A-shield plate	1
MP181*	8510013720	2356 S-plate assembly	1
MP182	8510002280	VCO shield plate (A)	1
MP183	8510013690	2356 S-plate	1
MP184	8930004070	Earth spring (C)	1
MP241	8510013830	2356 B-shield plate	1
MP242	8930030380	Ferrite sheet (C)	1
MP243	8510002280	VCO shield plate (A)	1
MP244	8930054900	2356 earth spring	1
MP245	8930054900	2356 earth spring	1
MP251	8510010460	1691 main shield plate	1
MP281	8930014140	Earth spring (D)	1
MP312	8950000180	Cable tie -80	2
MP331	8930054470	Ferrite sheet (I)	1
MP501*	8510013490	2356 PLL case	1
MP541*	8510013500	2356 VCO case	1
MP542	8930021270	VCO shield plate	1
MP543	8930007720	Insulation sheet AB	1
MP544	8930054810	Ferrite sheet (J)	1
MP545	8930043831	Insulation sheet FF-1	1
MP601*	8510012750	1386 PLL case	1
MP602*	8510010850	1897 D/A case	1
MP603	8930054520	Shield sponge (E)	1
MP661	8930014140	Earth spring (D)	1
MP701*	8510000881	194 VCO case-1	1
MP702	8510003460	194 VCO case cover (A)	1
MP703	8930038430	778 A-sponge	1
MP741	8930014140	Earth spring (D)	1

[UX-910 UNPACKING]

REF. NO.	ORDER NO.	DESCRIPTION	QTY.
MP1	8810003380	Setscrew C M3 X 10	4

Screw abbreviations

BT: Self-tapping PH: Pan head
 FH: Flat head Bih: Binding head
 NI: Nickel NI-ZU: Nickel-zinc
 BS: Brass ZK: Black

* Refer to Section 9 BOARD LAYOUTS.





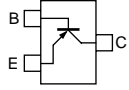
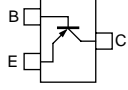
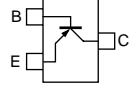
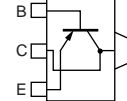
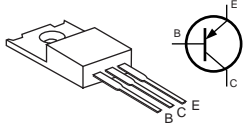
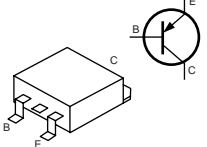
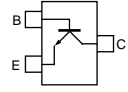
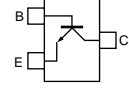
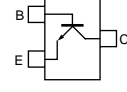
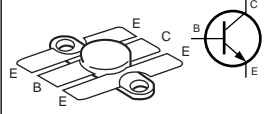
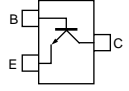
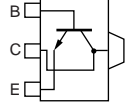
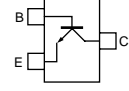
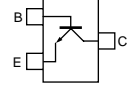
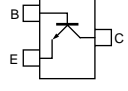
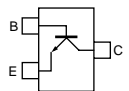
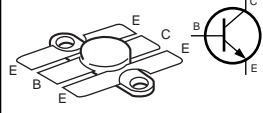
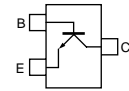
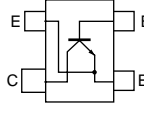
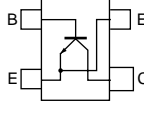
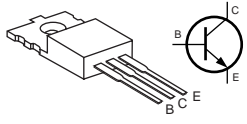
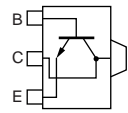
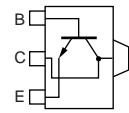
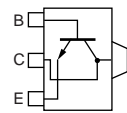
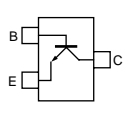
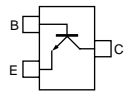
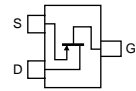
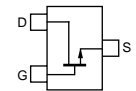
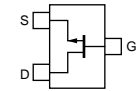
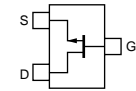
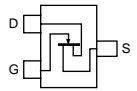
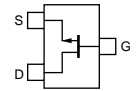
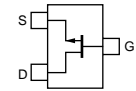
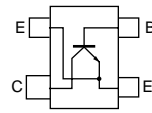
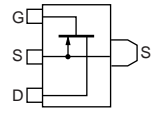

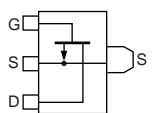
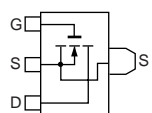
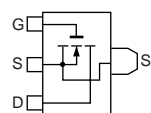
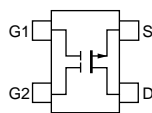
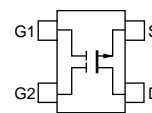
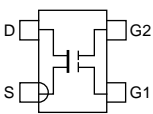
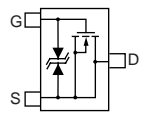
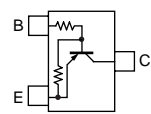
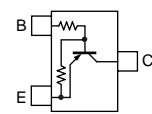
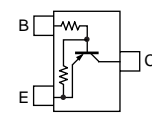
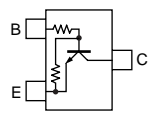
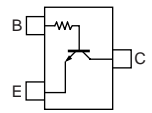
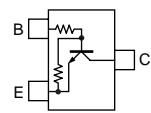
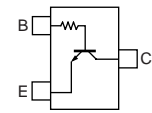
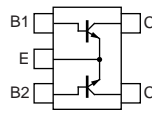
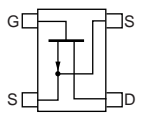
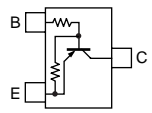
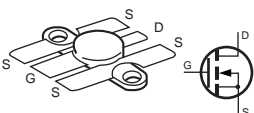
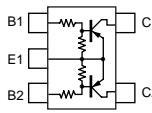
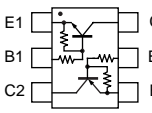
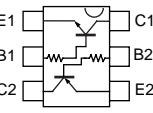
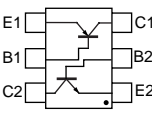



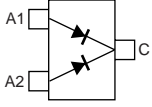

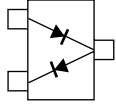
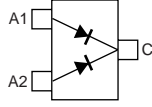
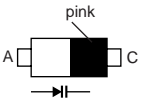

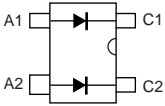

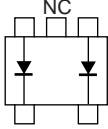

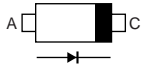
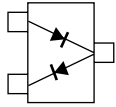
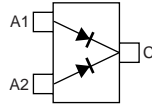
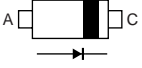
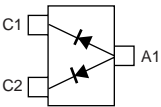
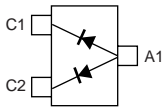
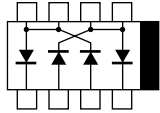
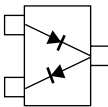

SECTION 8 SEMI-CONDUCTOR INFORMATION

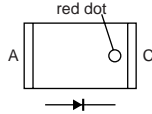
• TRANSISTORS AND FET'S

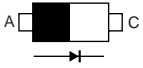
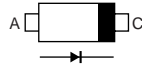
<p>2SA1162 GR (Symbol: SG)</p> 	<p>2SA1586 GR (Symbol: SG)</p> 	<p>2SA1588 GR (Symbol: ZG)</p> 	<p>2SB1132 T100 R (Symbol: BAR)</p> 	<p>2SB1133 R (Symbol: B1133)</p> 
<p>2SB1201 S (Symbol: B1201)</p> 	<p>2SC2712 BL (Symbol: BL)</p> 	<p>2SC2712 GR (Symbol: LG)</p> 	<p>2SC2714 O (Symbol: QO)</p> 	<p>2SC3102 (Symbol: None)</p> 
<p>2SC3356 T2B (Symbol: R24)</p> 	<p>2SC3357 T2 (Symbol: RK)</p> 	<p>2SC4081 T107 R (Symbol: BR)</p> 	<p>2SC4116 GR (Symbol: LG)</p> 	<p>2SC4215 O (Symbol: QO)</p> 
<p>2SC5107 O (Symbol: MFO)</p> 	<p>2SC5125</p> 	<p>2SC5193 T1 (Symbol: T88)</p> 	<p>2SC5454 R54 (Symbol: R54)</p> 	<p>2SC5508 (Symbol: T79)</p> 
<p>2SD1585 K (Symbol: None)</p> 	<p>2SD1619 T TD (Symbol: DB)</p> 	<p>2SD1664 T100Q (Symbol: DAQ)</p> 	<p>2SD1801 S TL (Symbol: CE)</p> 	<p>2SD2216 S (Symbol: Y)</p> 
<p>2SD2345 S (Symbol: 1Z)</p> 	<p>2SJ364 Q (Symbol: 4MQ)</p> 	<p>2SK302 Y (Symbol: TY)</p> 	<p>2SK508 K52 T2B (Symbol: K52)</p> 	<p>2SK880 Y (Symbol: XY)</p> 
<p>2SK882 GR (Symbol: TGR)</p> 	<p>2SK1577 2 T7 (Symbol: P2)</p> 	<p>2SK1740 (Symbol: IJ)</p> 	<p>2SK1829 (Symbol: K1)</p> 	<p>2SK2854 (Symbol: UP)</p> 

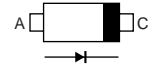
<p>2SK2855 (Symbol: UT)</p> 	<p>2SK2973 (Symbol: K1)</p> 	<p>2SK2975</p> 	<p>3SK131 T2 LA (Symbol: V12)</p> 	<p>3SK177 T1B U73 (Symbol: U73)</p> 
<p>3SK241 R (Symbol: DU)</p> 	<p>CPH3404-TL (Symbol: KD)</p> 	<p>DTA114 EE TL (Symbol: 14)</p> 	<p>DTA114EUA T106 (Symbol: 16)</p> 	<p>DTA144EUA T106 (Symbol: 16)</p> 
<p>DTC114EUA T106 (Symbol: 24)</p> 	<p>DTC114TUA T106 (Symbol: 04)</p> 	<p>DTC144EUA T106 (Symbol: 26)</p> 	<p>DTC144TU T107 (Symbol: 06)</p> 	<p>FMW1 T148 (Symbol: W1)</p> 
<p>NE34018 T1 (Symbol: V63)</p> 	<p>RN2425 (Symbol: RE)</p> 	<p>SRFJ7044 (Symbol: SRFJ7044)</p> 	<p>XP1113 (Symbol: 7L)</p> 	<p>XP4312 (Symbol: 7T)</p> 
<p>XP4315 (Symbol: CB)</p> 	<p>XP4601 (Symbol: 5C)</p> 			

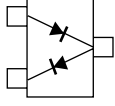
• DIODES

<p>1SS301 (Symbol: B3)</p> 	<p>1SS355 (Symbol: A)</p> 	<p>1SS375-TL (Symbol: FH)</p> 	<p>1SS385 (Symbol: 09)</p> 	<p>1SV214 (Symbol: T1)</p> 
<p>1SV217 (Symbol: T6)</p> 	<p>1SV237 (Symbol: BB)</p> 	<p>1SV239 (Symbol: TC)</p> 	<p>1SM265 TL (Symbol: LV)</p> 	<p>1SV286 (Symbol: T7)</p> 
<p>1SV307 (Symbol: TX)</p> 	<p>1SV308 (Symbol: TX)</p> 	<p>DA221 (Symbol: K)</p> 	<p>DAN202 U T107 (Symbol: N)</p> 	<p>DAN222TL (Symbol: N)</p> 
<p>DAP202K T146 (Symbol: P)</p> 	<p>DAP222 TL (Symbol: P)</p> 	<p>HSB88WSTR (Symbol: Silver line)</p> 	<p>HSM88AS TR (Symbol: C1)</p> 	<p>HSU88TRF (Symbol: 9)</p> 
<p>MA29B (Symbol: Y)</p> 	<p>MA2S111 (Symbol: A)</p> 	<p>MA357 (Symbol: 7K)</p> 	<p>MA4PH224 (Symbol: Red dot)</p> 	<p>MA728 (Symbol: 2A)</p> 
<p>MA77 (Symbol: 4B)</p> 	<p>MA8030 H (Symbol: 3^0)</p> 	<p>MA8043 L (Symbol: 4_3)</p> 	<p>MA8047 H (Symbol: 4^7)</p> 	<p>MA8068 M (Symbol: 6-8)</p> 
<p>MA8082 M (Symbol: 8-2)</p> 	<p>RB706F-40 T106 (Symbol: 3J)</p> 	<p>SB07-03C (Symbol: J)</p> 		

SECTION 9 BOARD LAYOUTS

9-1 VR-A BOARD

• TOP VIEW

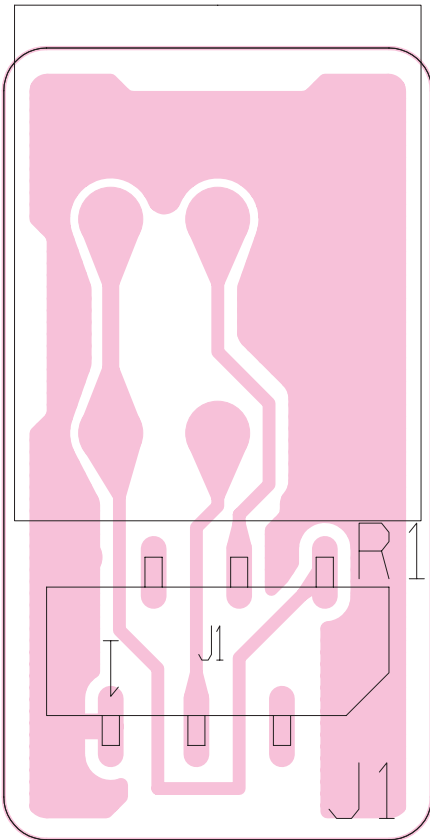

to DISPLAY board J2

9-3 RIT BOARD

• TOP VIEW

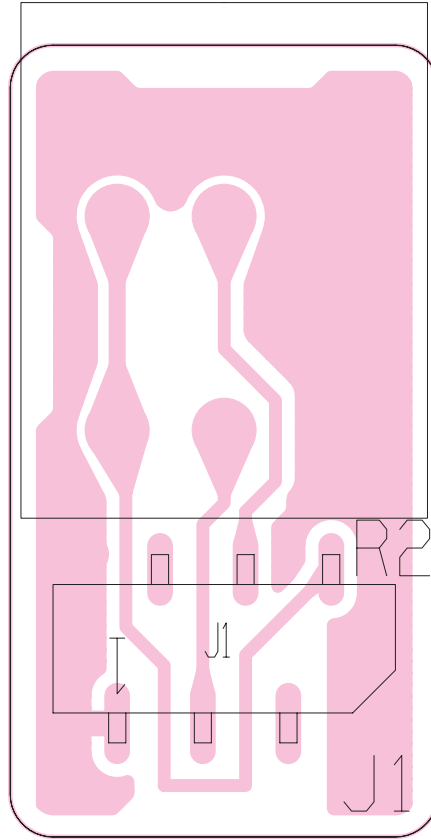

to DISPLAY board J10

9-2 VR-B BOARD

• TOP VIEW

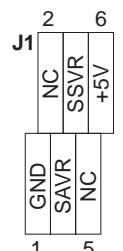
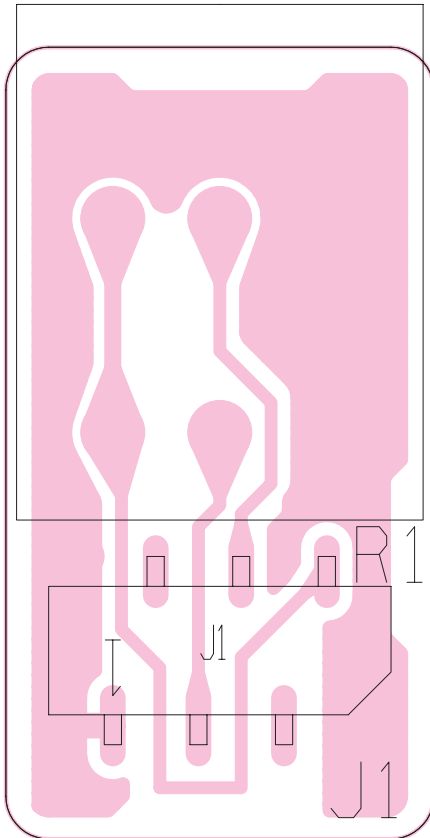

to DISPLAY board J11

• **BOTTOM VIEW (RIT BOARD)**

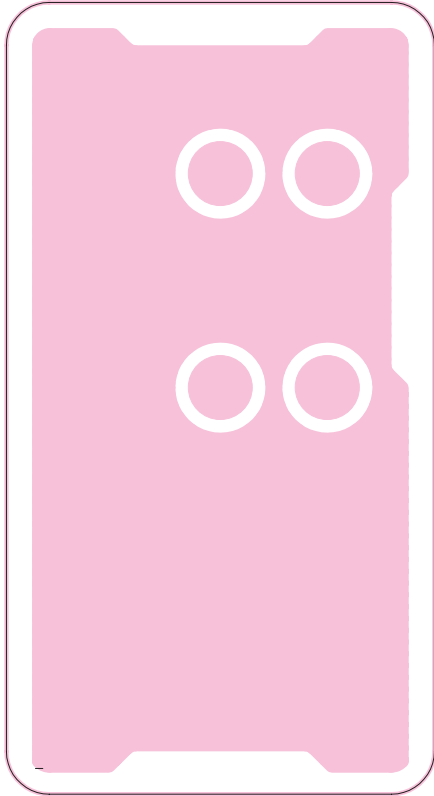

• **BOTTOM VIEW (VR-A BOARD)**

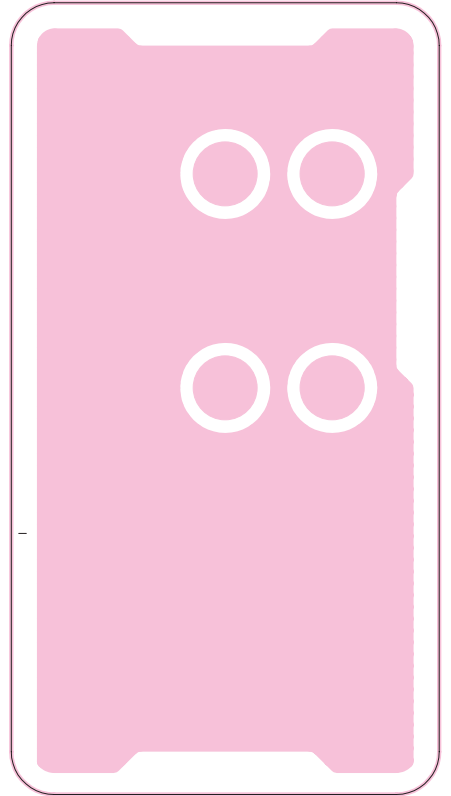

• **BOTTOM VIEW (VR-B BOARD)**

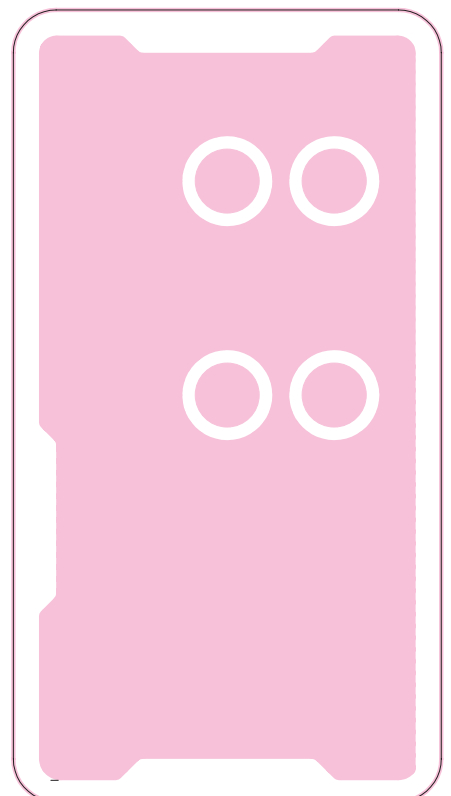

9-4 FUNC BOARD

• TOP VIEW

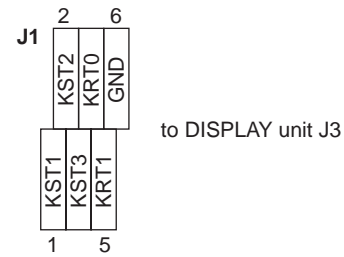
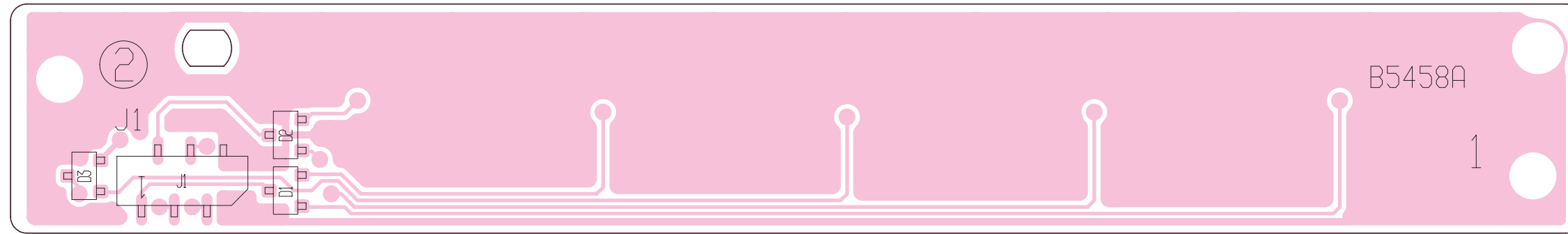

9-5 MIC BOARD

• TOP VIEW

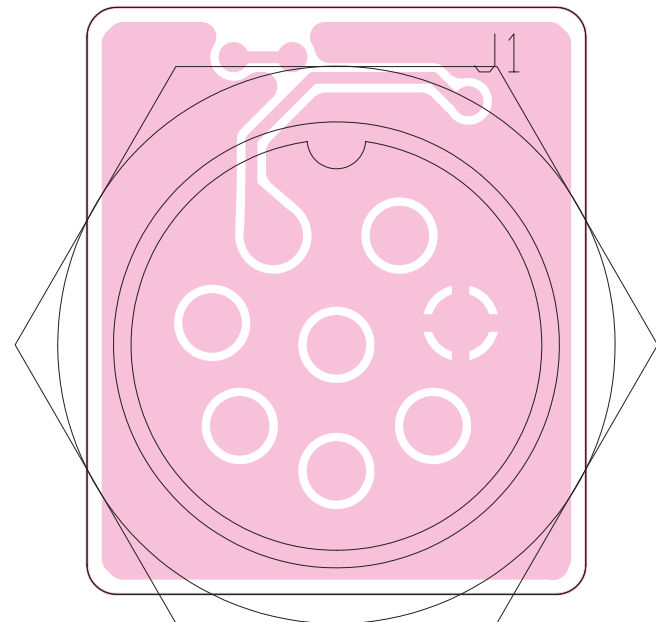

9-6 JACK BOARD

• TOP VIEW

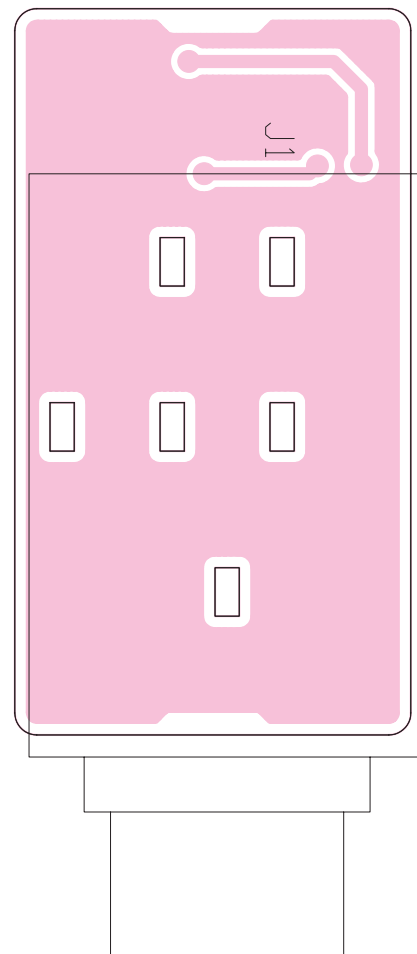

9-7 DRV BOARD

• TOP VIEW

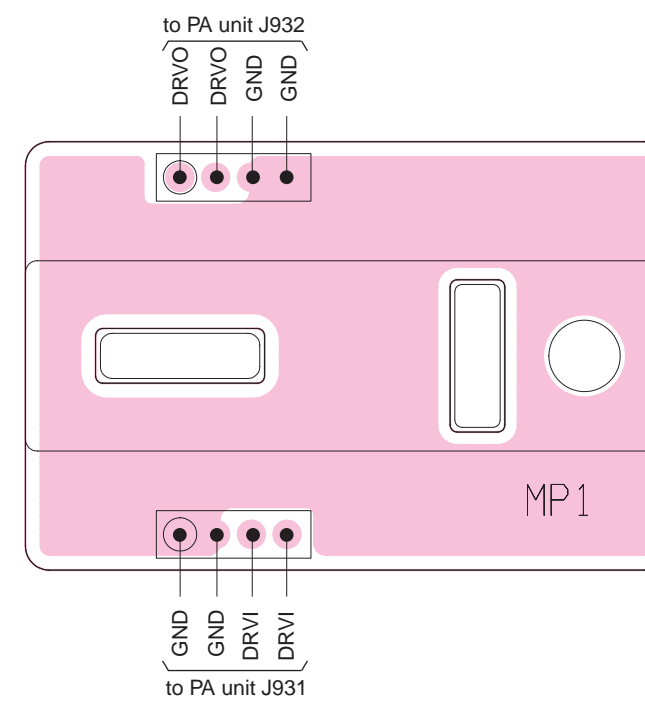

9-8 VARISTOR-A BOARD

• TOP VIEW

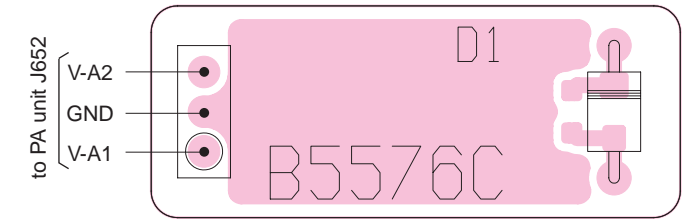

9-9 VARISTOR-B BOARD

• TOP VIEW



9-10 VARISTOR-C BOARD

• TOP VIEW

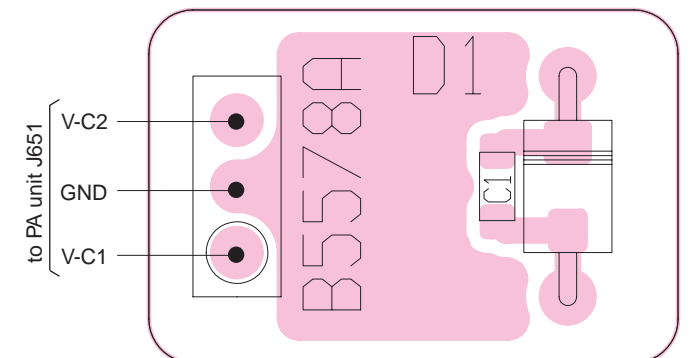

• BOTTOM VIEW (VARISTOR-A BOARD)



• BOTTOM VIEW (FUNC BOARD)

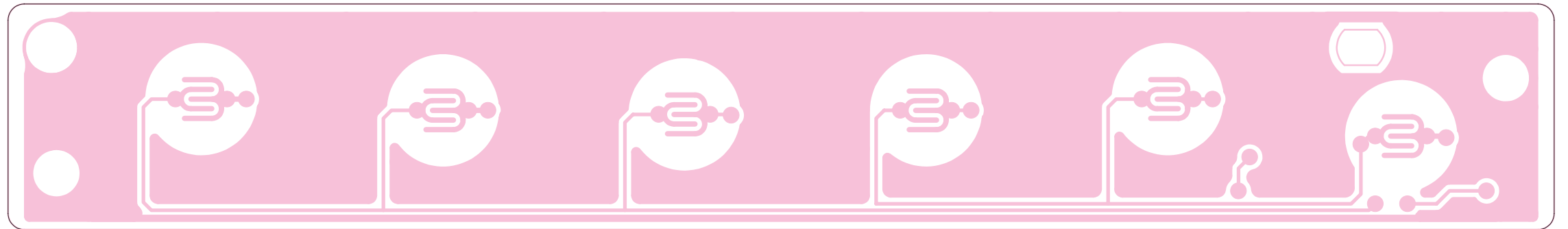

• BOTTOM VIEW (VARISTOR-B BOARD)



• BOTTOM VIEW (DRV BOARD)

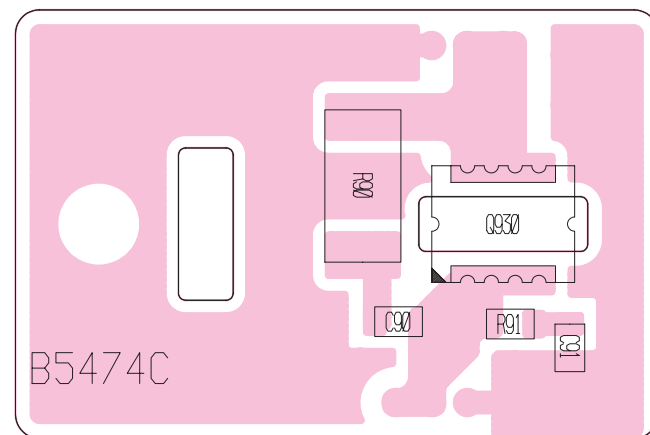

• BOTTOM VIEW (VARISTOR-C BOARD)

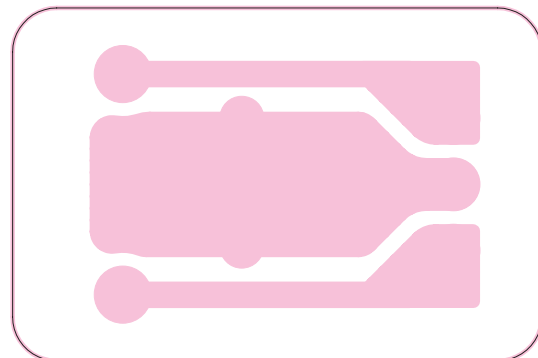

• BOTTOM VIEW (JACK BOARD)

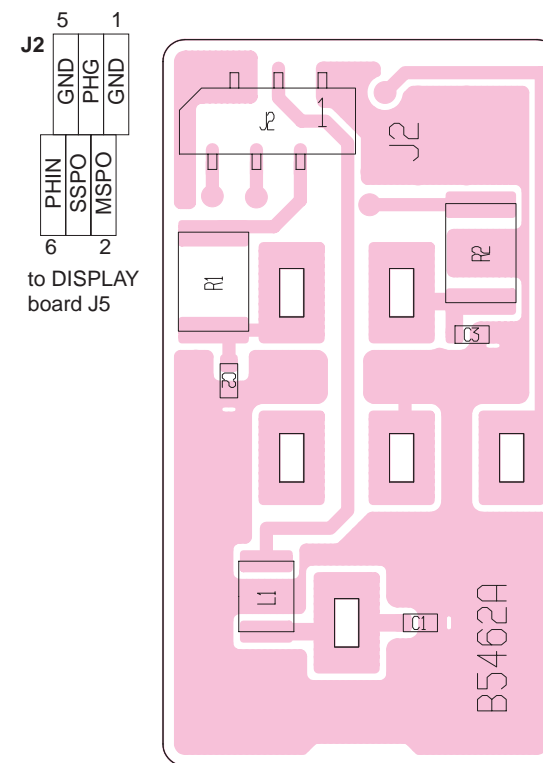

• BOTTOM VIEW (MIC BOARD)

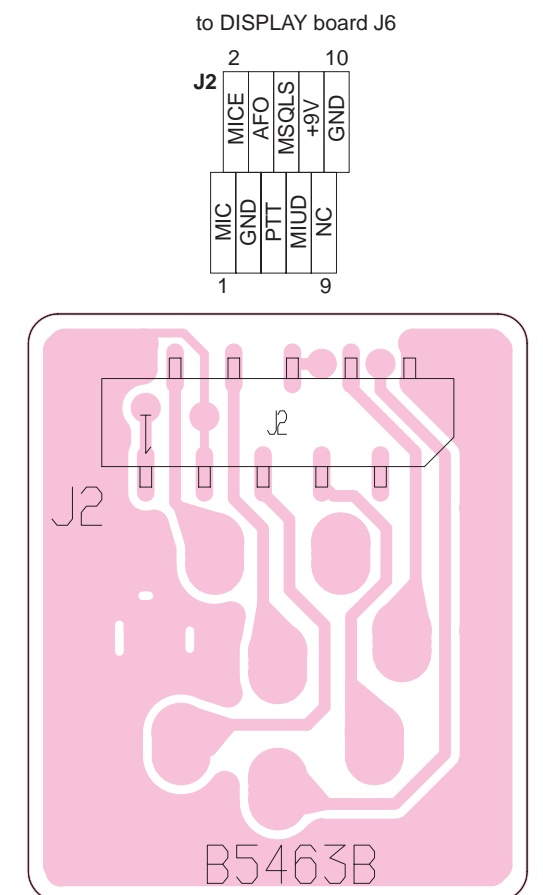

9-11 DISPLAY BOARD

• TOP VIEW

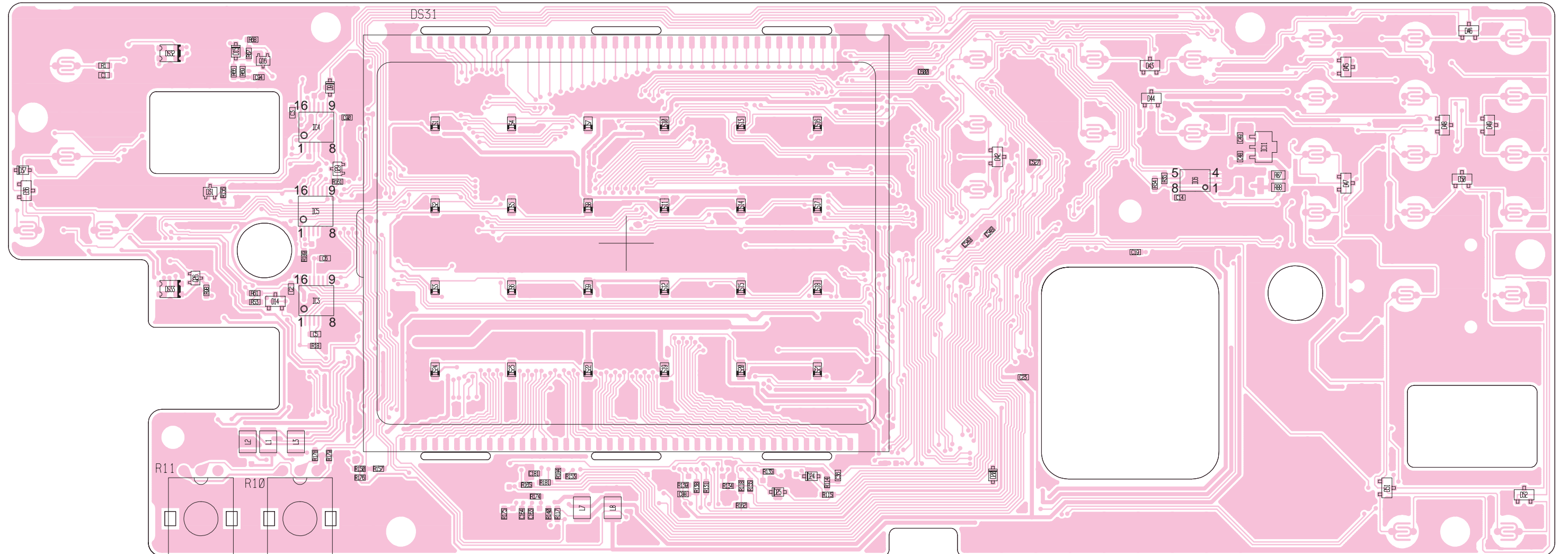

• BOTTOM VIEW (DISPLAY BOARD)

to FUNC board J1

J3	
5	1
KST2	KRT0
KST3	KRT1
6	2

to PLL unit J1

J9	
19	1
PCK	14DT
PDAT	PST4
43DT	14UL
14UL	43UL
GND	GND
NC	NC
NC	BFST
14V	14V
+9V	NC
-5V	NC
20	2

to JACK board J2

J5			
1	PHIN	GND	2
	SSPO	PHG	
5	MSPO	GND	6

to VR-A board J1

J2			
1	+5V	NC	2
	MSVR	MAVR	
5	NC	GND	6

to MIC board J2

J6	
9	1
MICE	AFO
GND	MSQLS
PTT	MIUD
10	+9V
	NC
	2

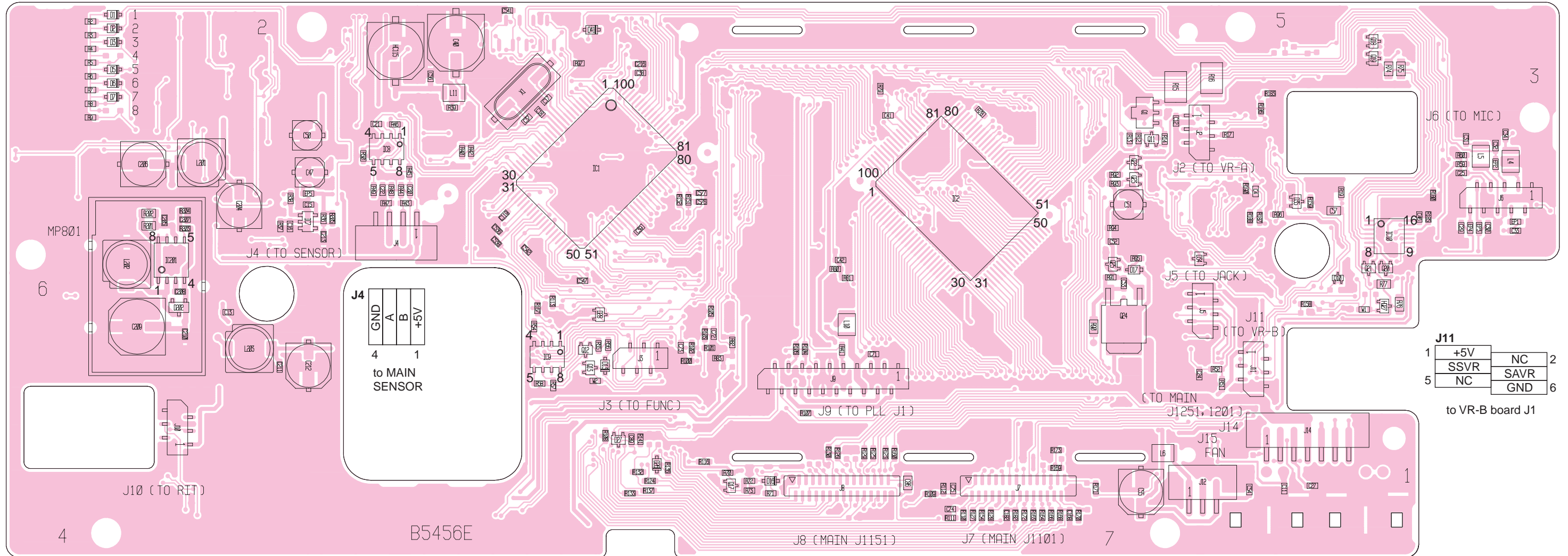

J4	
4	1
GND	A
	B
	+5V

to MAIN SENSOR

J11			
1	+5V	NC	2
	SSVR	SAVR	
5	NC	GND	6

to VR-B board J1

J10			
6	GND	NC	5
	RIVR	SFVR	
2	NC	+5V	1

to RIT board J1

J8	
1	29
GND	CIVE
	PTT1
	MIUD
	SEND
	DASH
	SBSY
	KDS
	AGRM
	SQLM
	SMLM
	CTCM
	BEEP
	CENS
	AGRS
	SQLS
	SMLS
	MSC
	OVDV
	TONC
	GND
2	30

to MAIN unit J1151

J7	
1	29
GND	INTM
	RXS
	MCK
	NC
	ETON
	VOXL
	NC
	PDAT
	FORL
	12PS
	12DS
	12UL
	14PV
	POWS
	12PV
	GND
2	30

to MAIN unit J1101

J12	
1	3
GND	FANV
	NC

to FAN

J14	
1	7
MSPO	
SSPO	
PHG	
14V	
HV	
MIC	
MICE	

to MAIN unit J1251, J1201

9-12 PA UNIT

• TOP VIEW

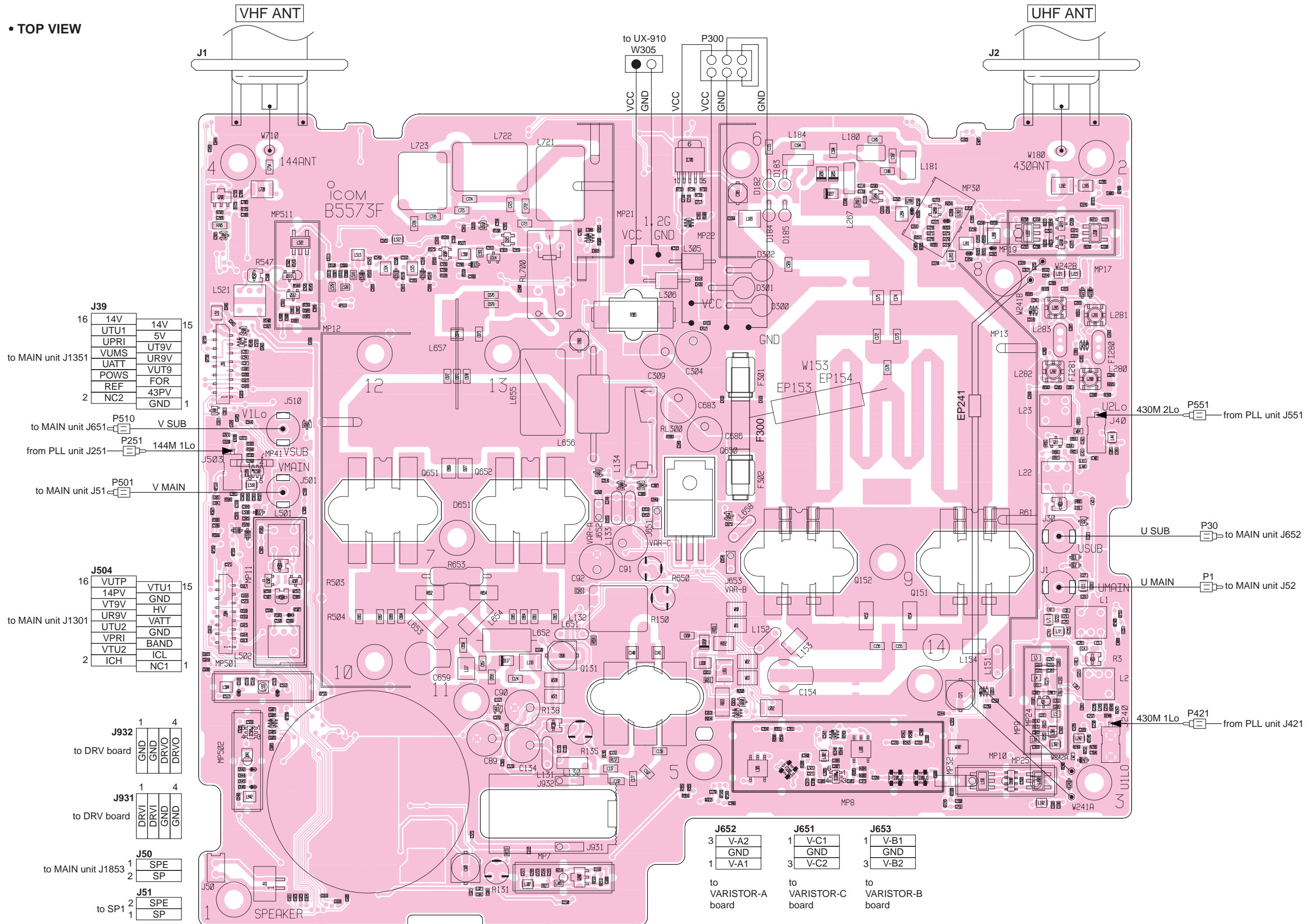

• BOTTOM VIEW (PA UNIT)

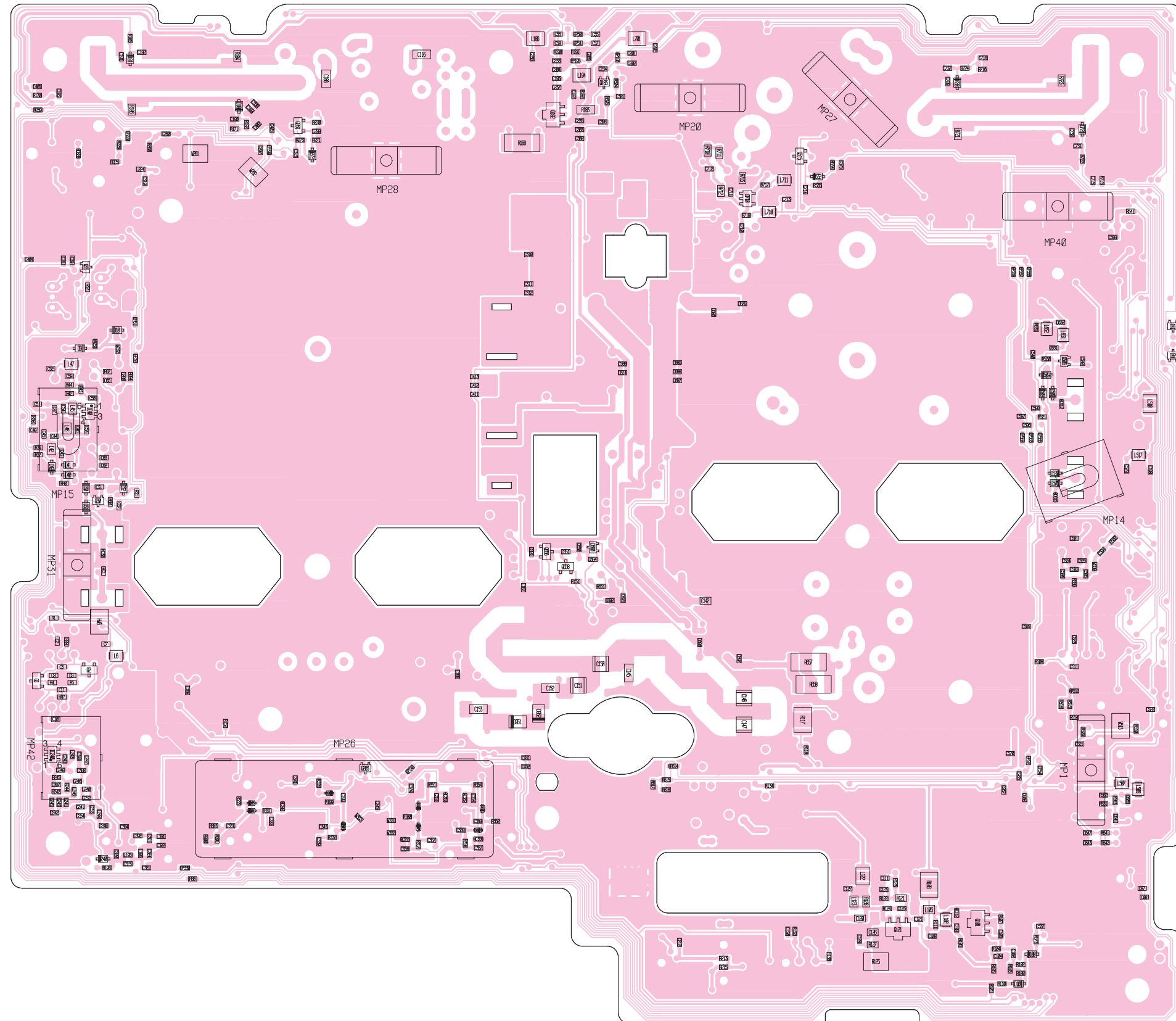

9-13 PLL UNIT

• TOP VIEW

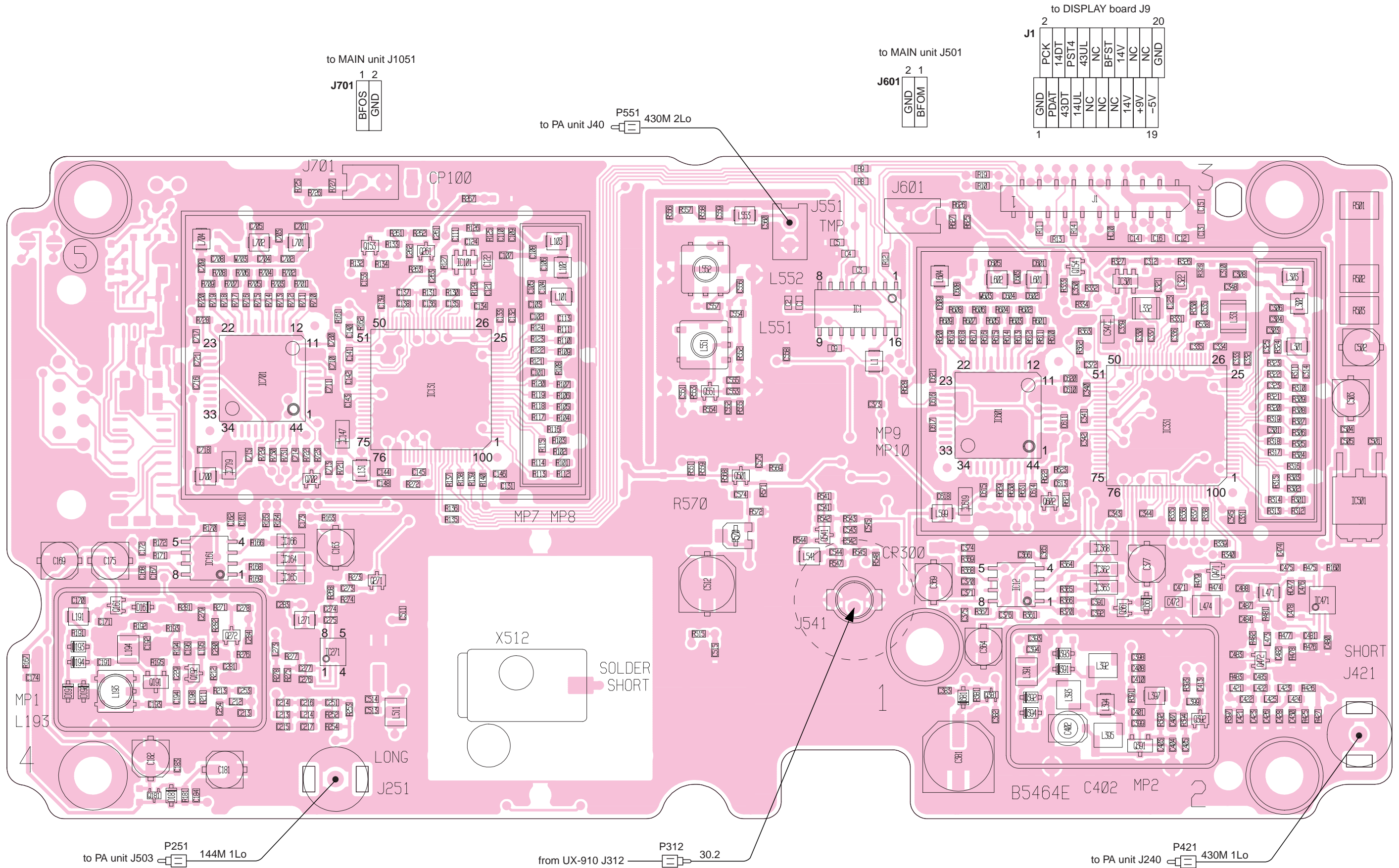

• BOTTOM VIEW (PLL UNIT)

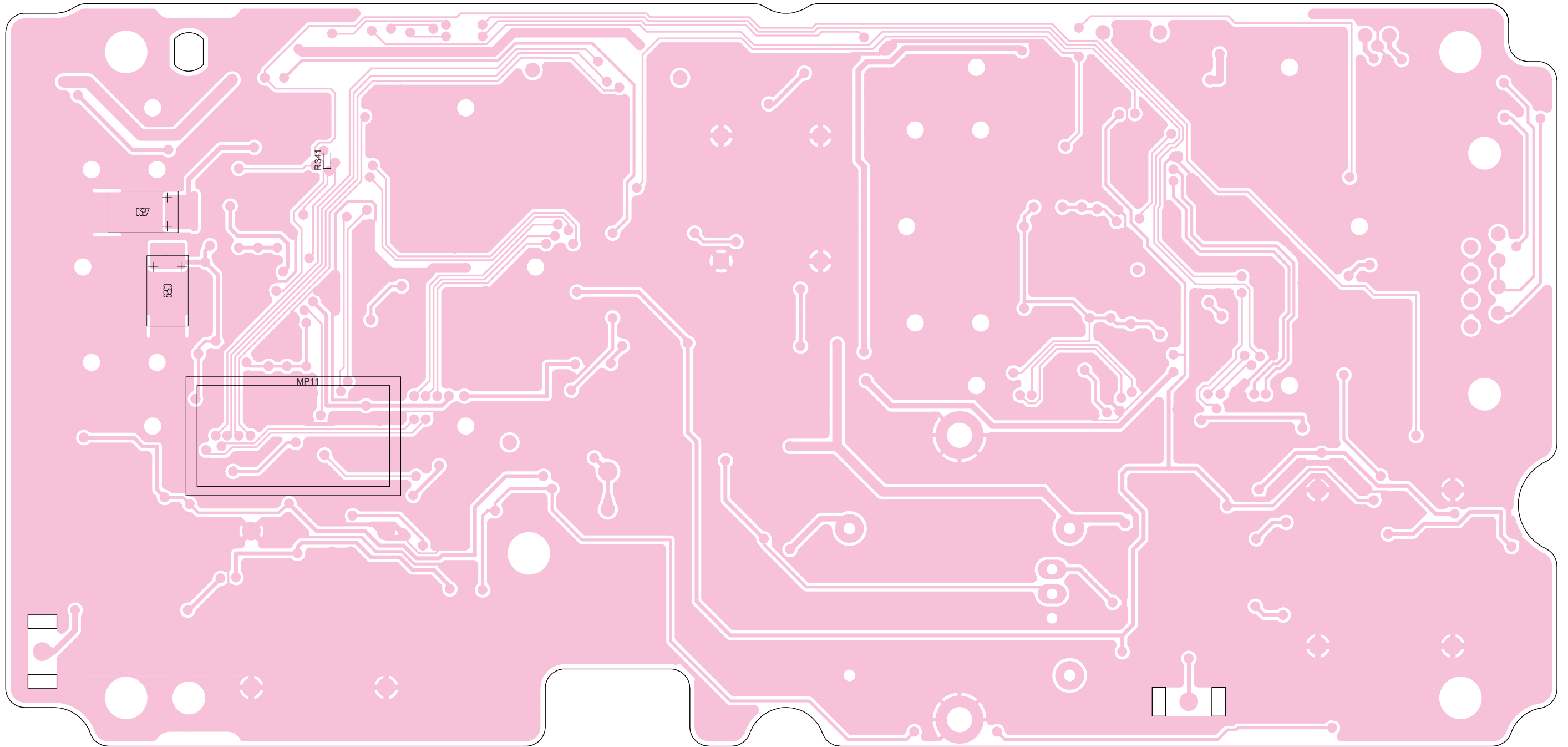

9-14 MAIN UNIT

• TOP VIEW

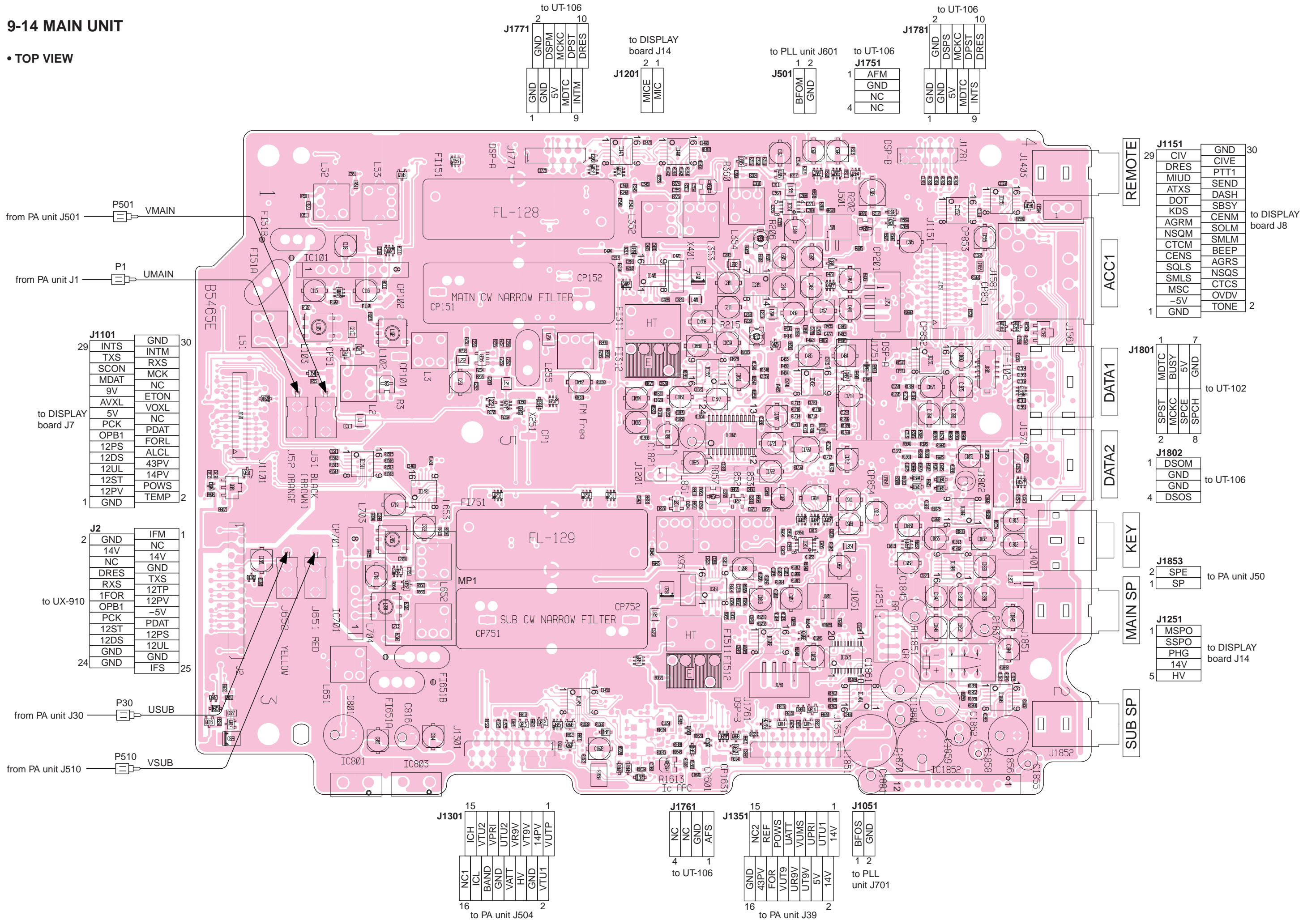

• BOTTOM VIEW (MAIN UNIT)

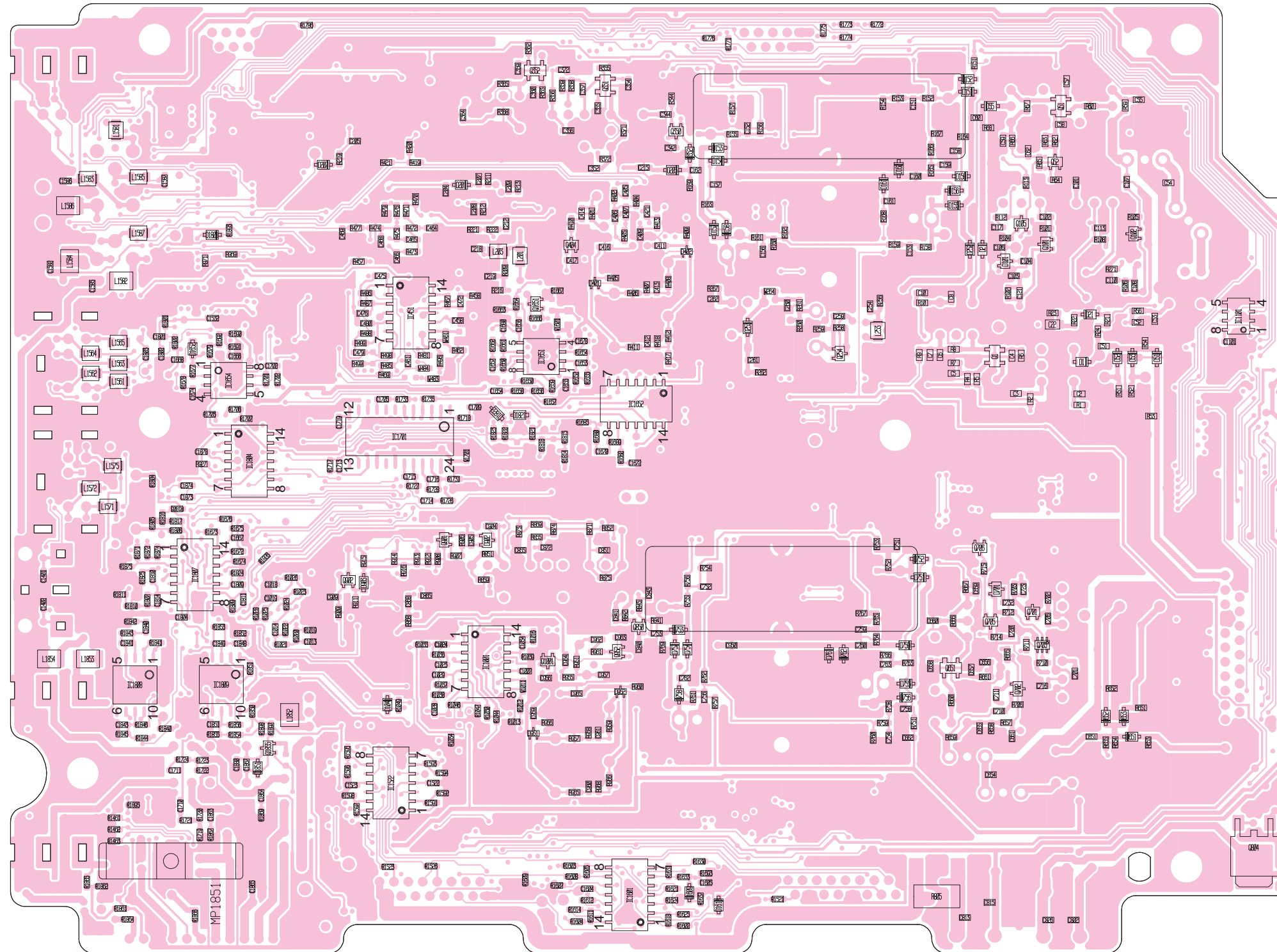

9-15 UX-910 MAIN UNIT

• TOP VIEW

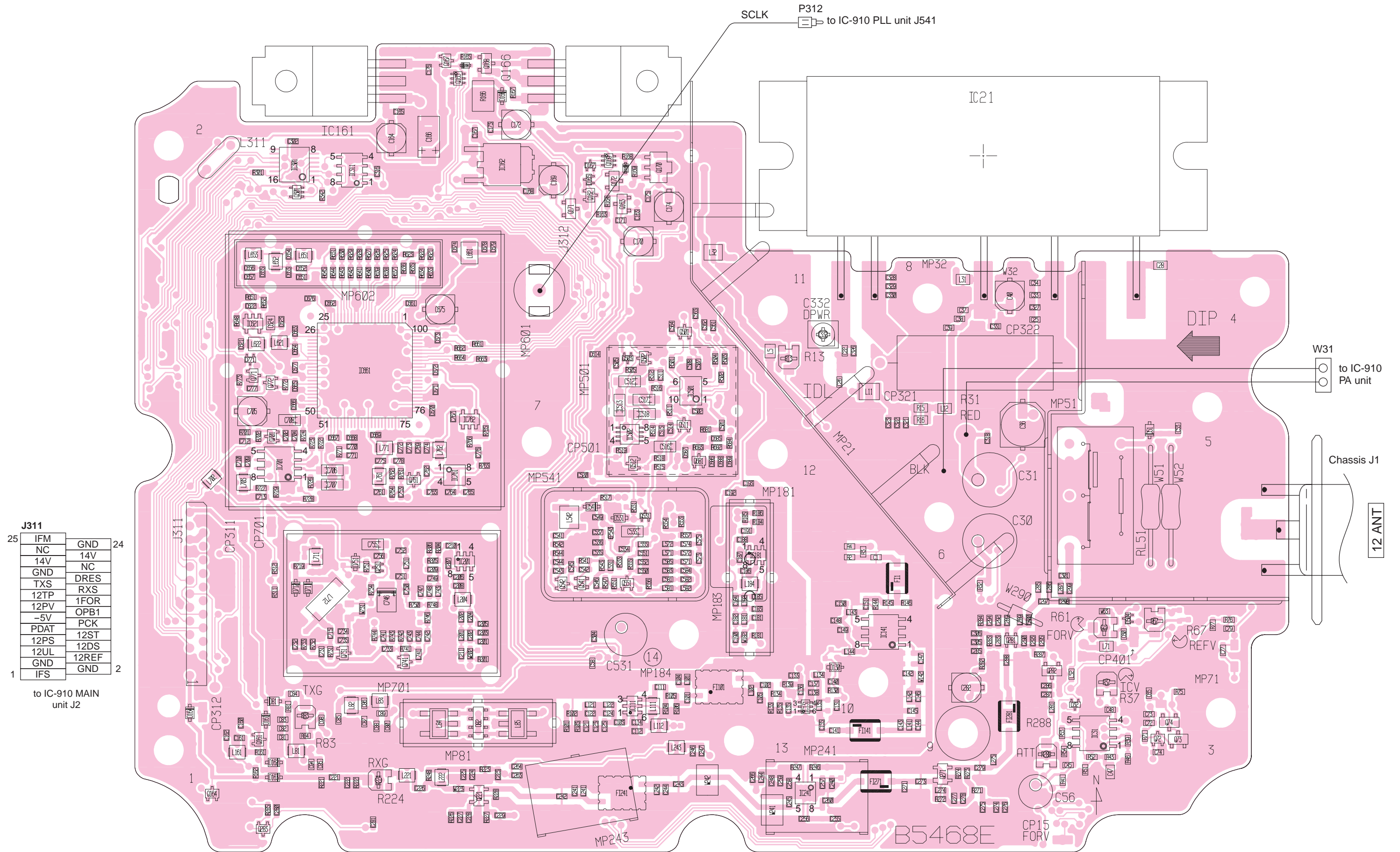

J311

25	IFM	GND	24
	NC	14V	
	14V	NC	
	GND	DRES	
	TXS	RXS	
	12TP	1FOR	
	12PV	OPB1	
	-5V	PCK	
	PDAT	12ST	
	12PS	12DS	
	12UL	12REF	
1	GND	GND	2
	IFS		

to IC-910 MAIN unit J2

• BOTTOM VIEW (UX-910 MAIN UNIT)

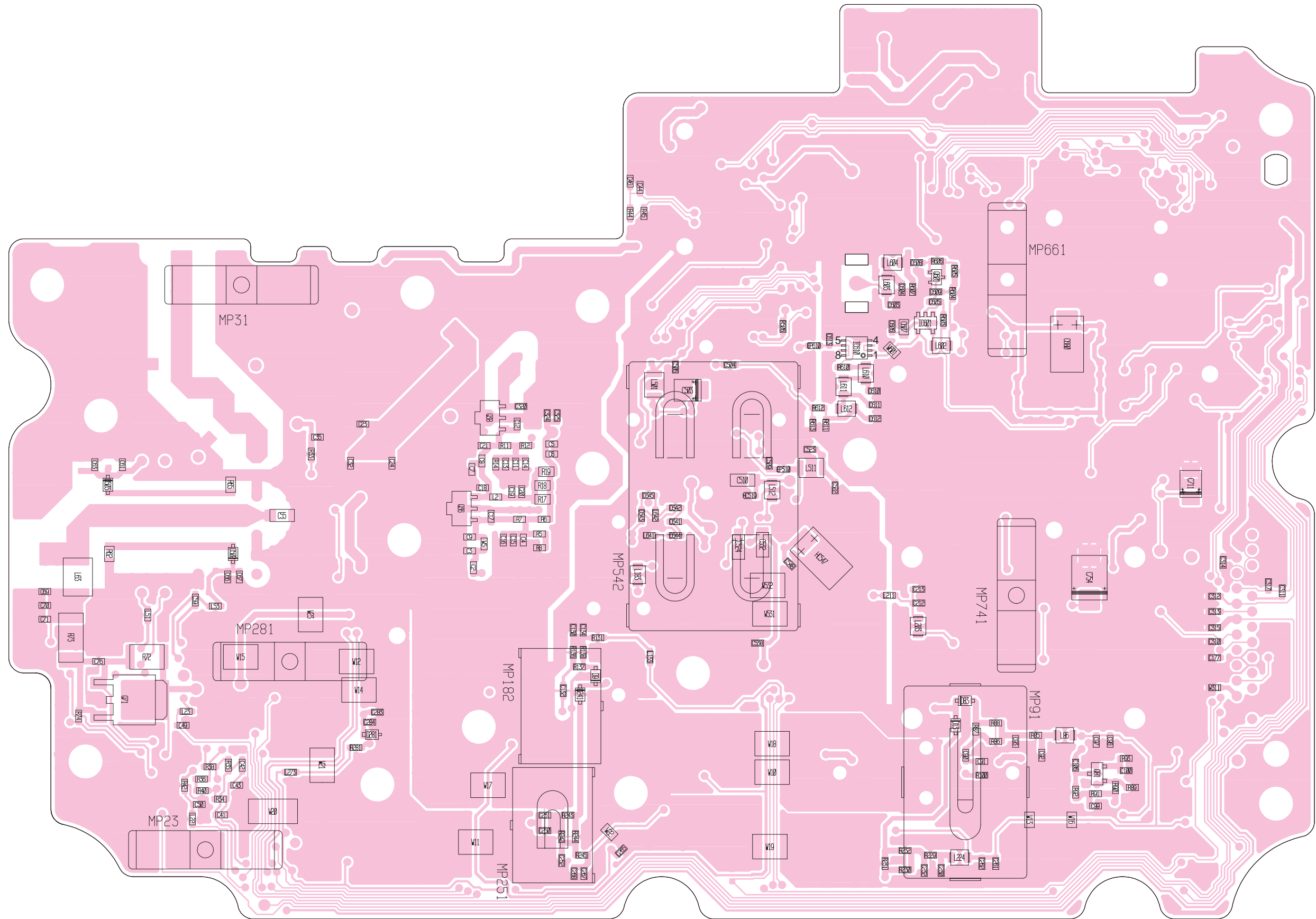

SECTION 10 BLOCK DIAGRAMS

10-1 MAIN UNIT

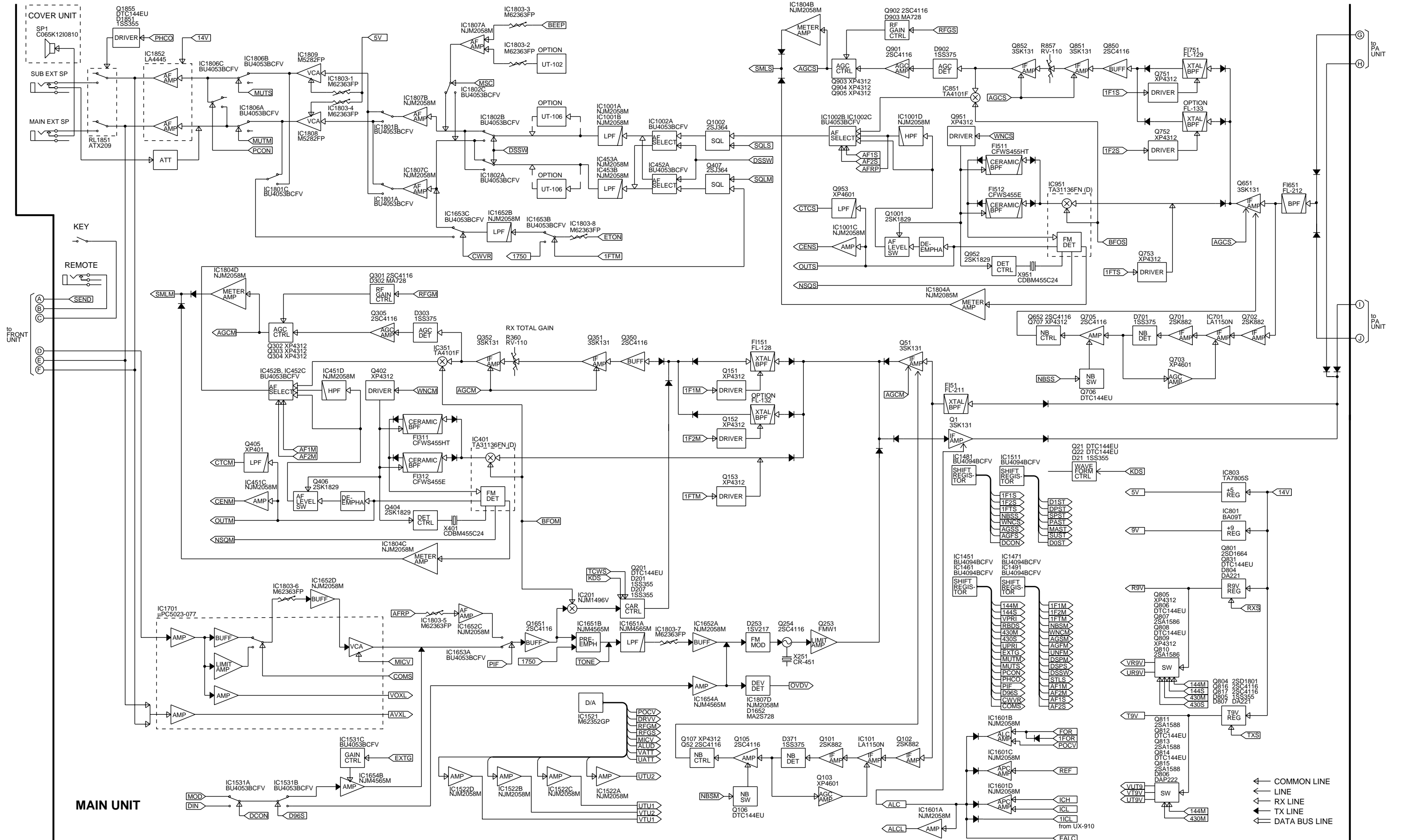

10-2 PA AND PLL UNITS

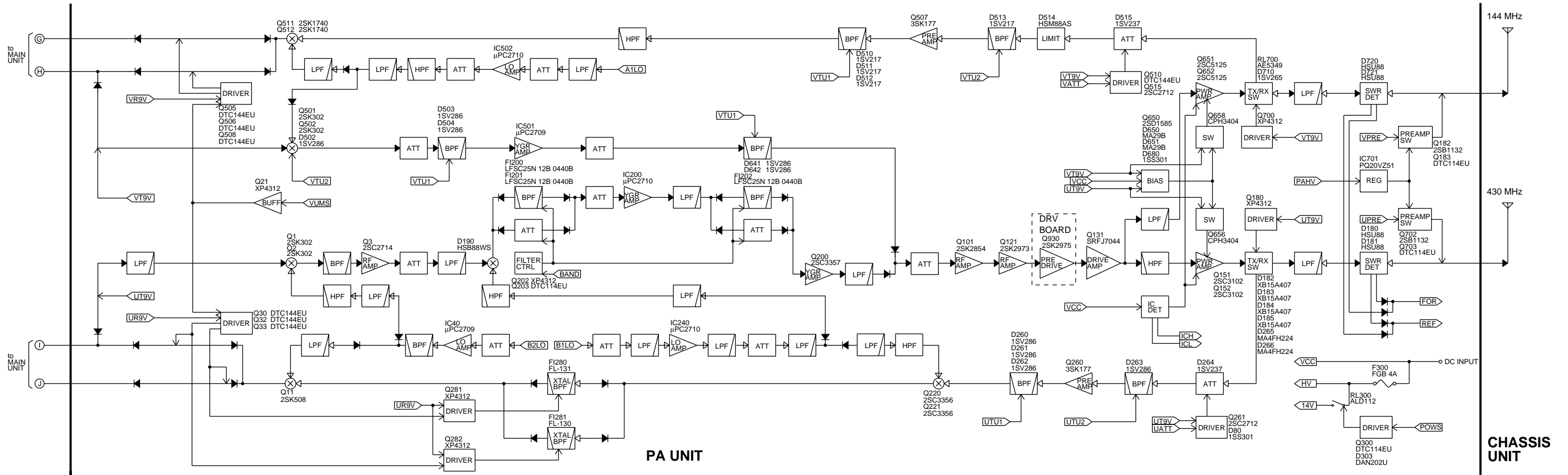

10-3 FRONT UNIT

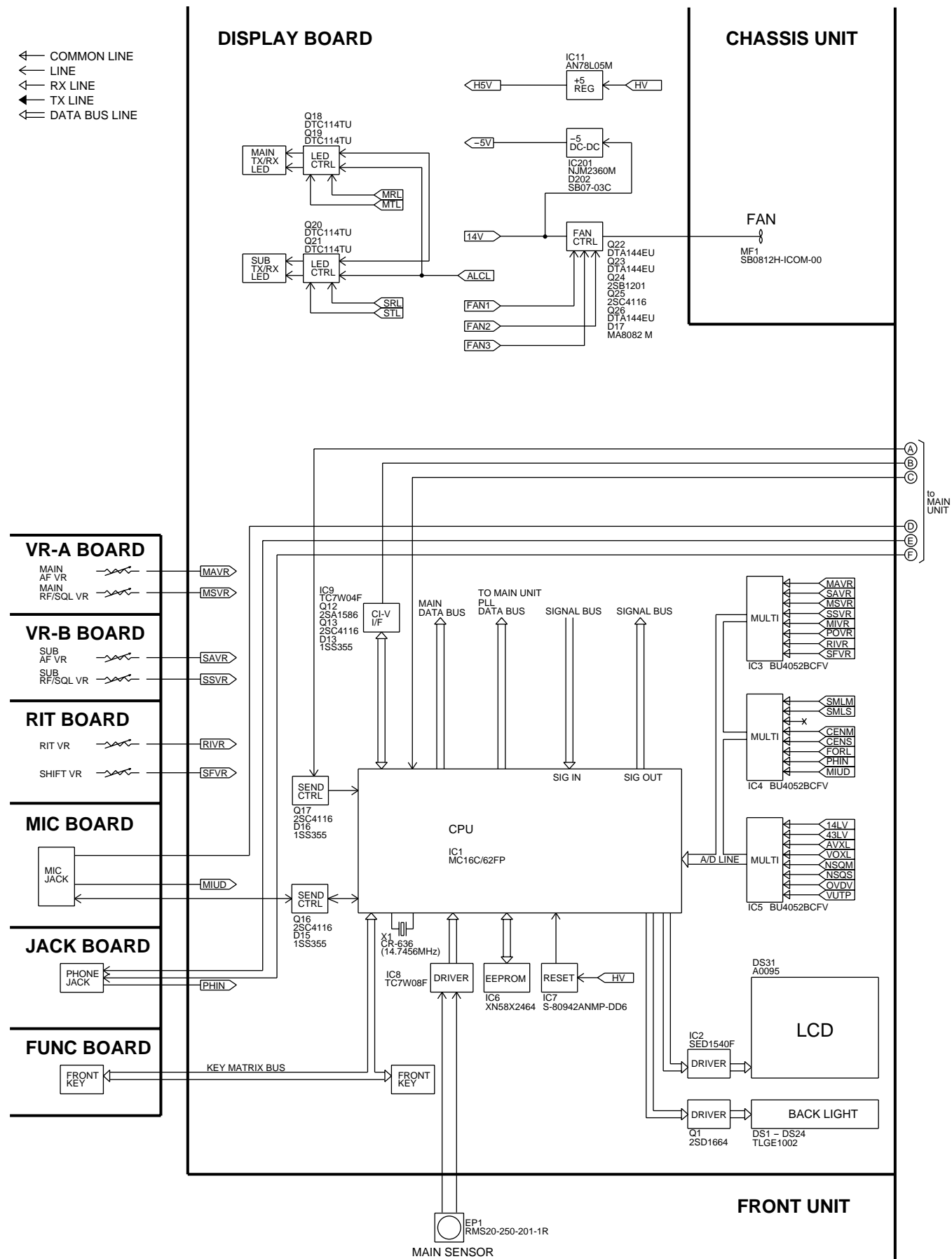

10-4 UX-910

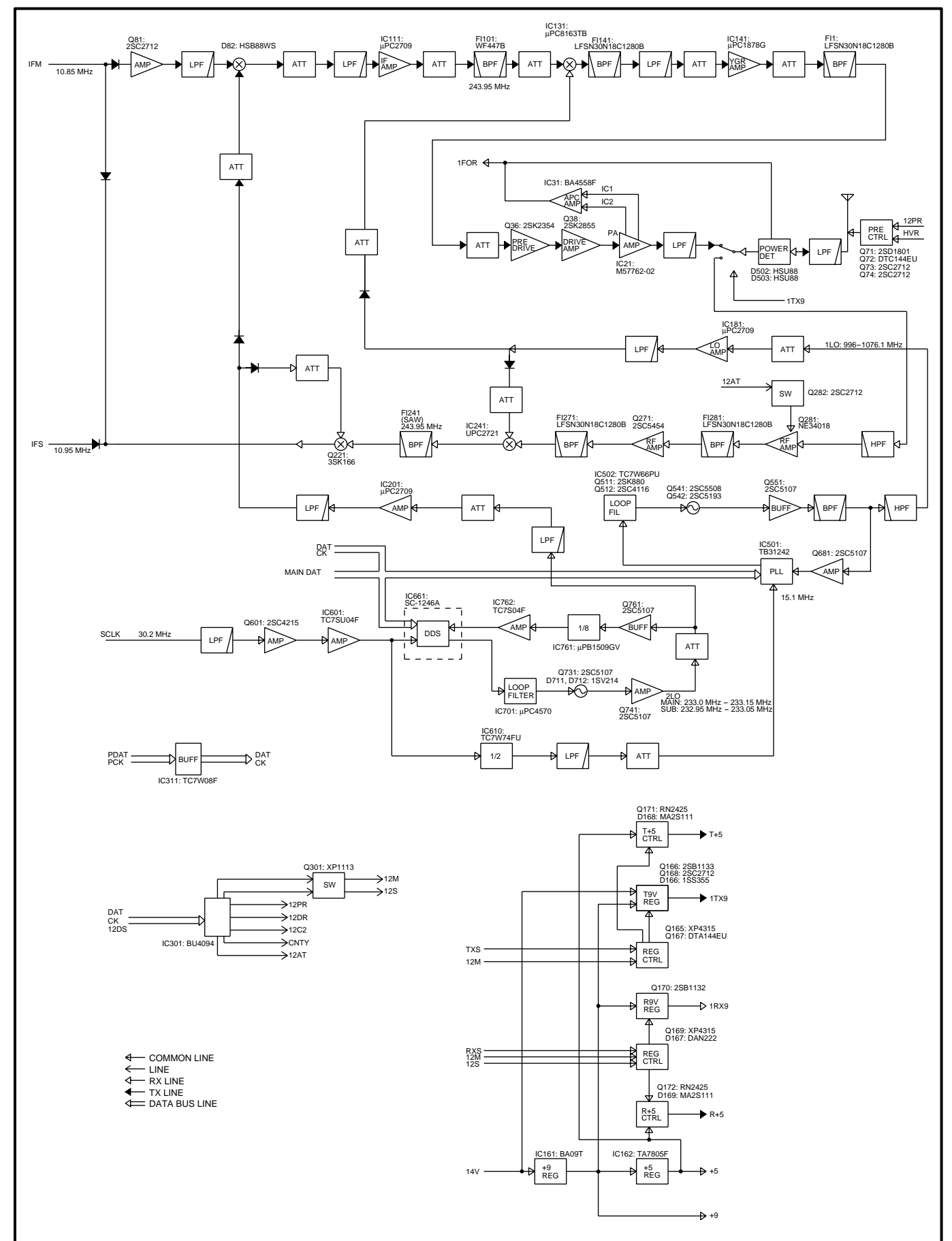

SECTION 11 WIRING DIAGRAM

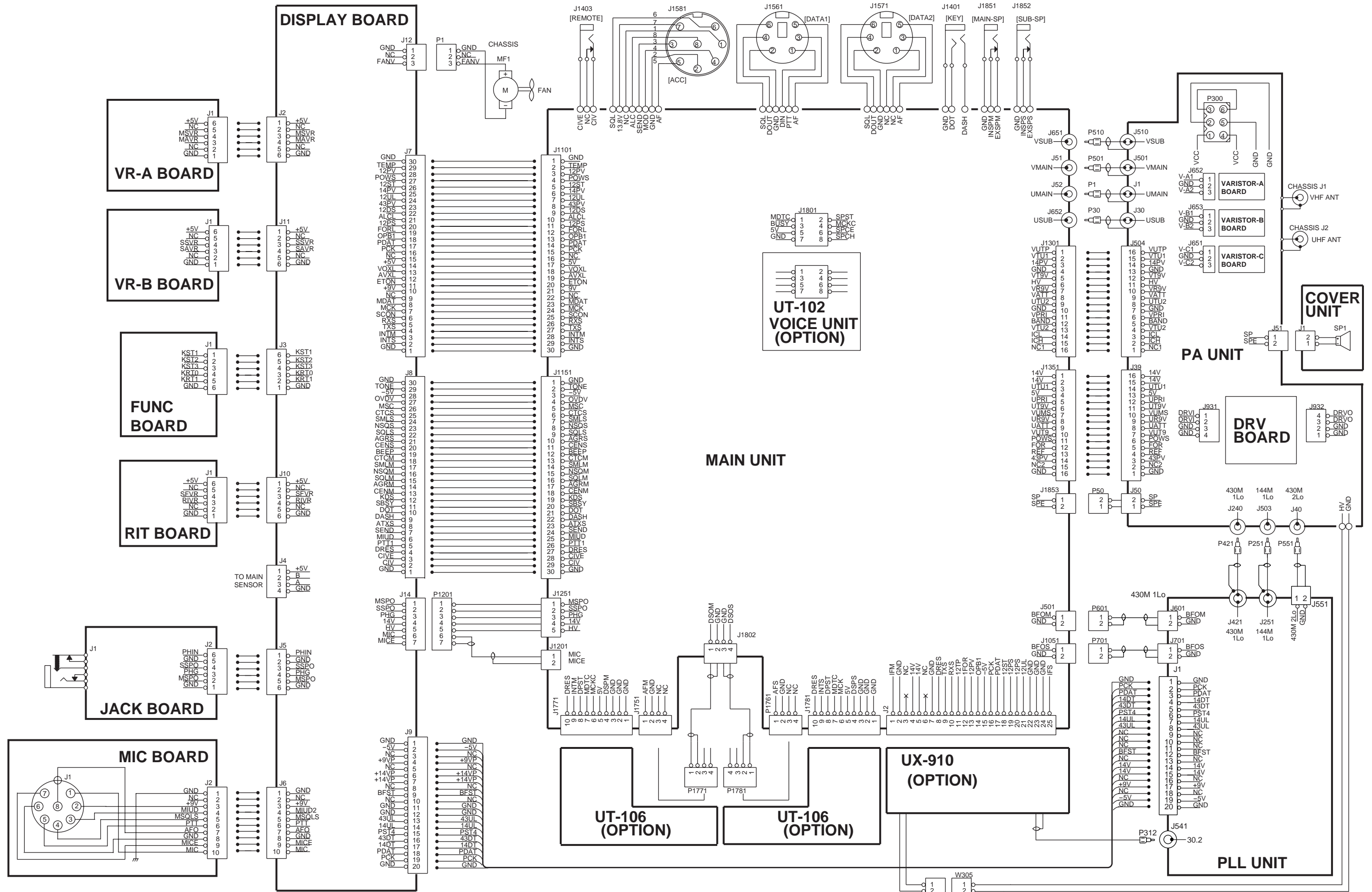

SECTION 12 VOLTAGE DIAGRAMS

12-1 FRONT UNIT

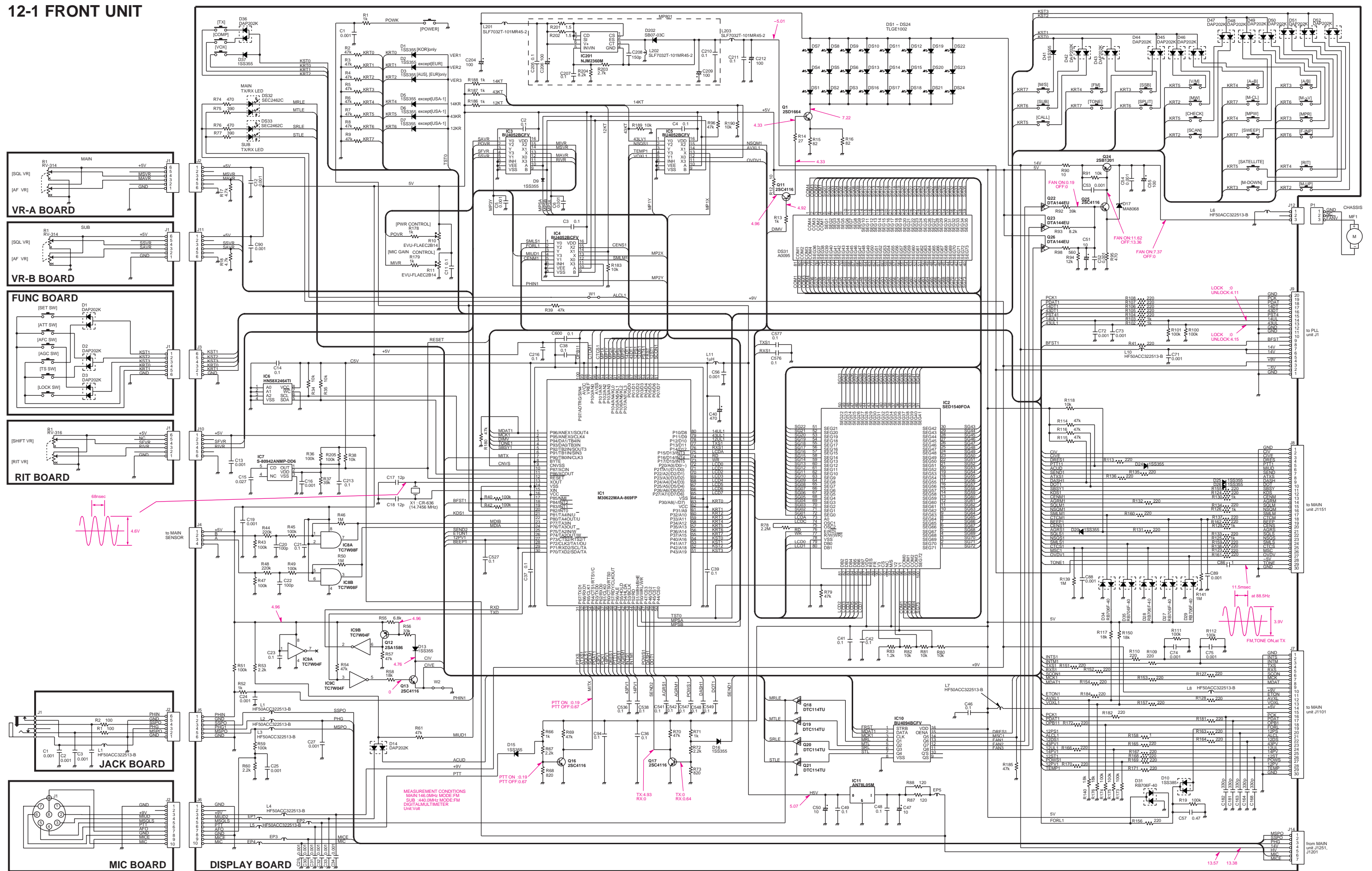

12-2 PLL UNIT

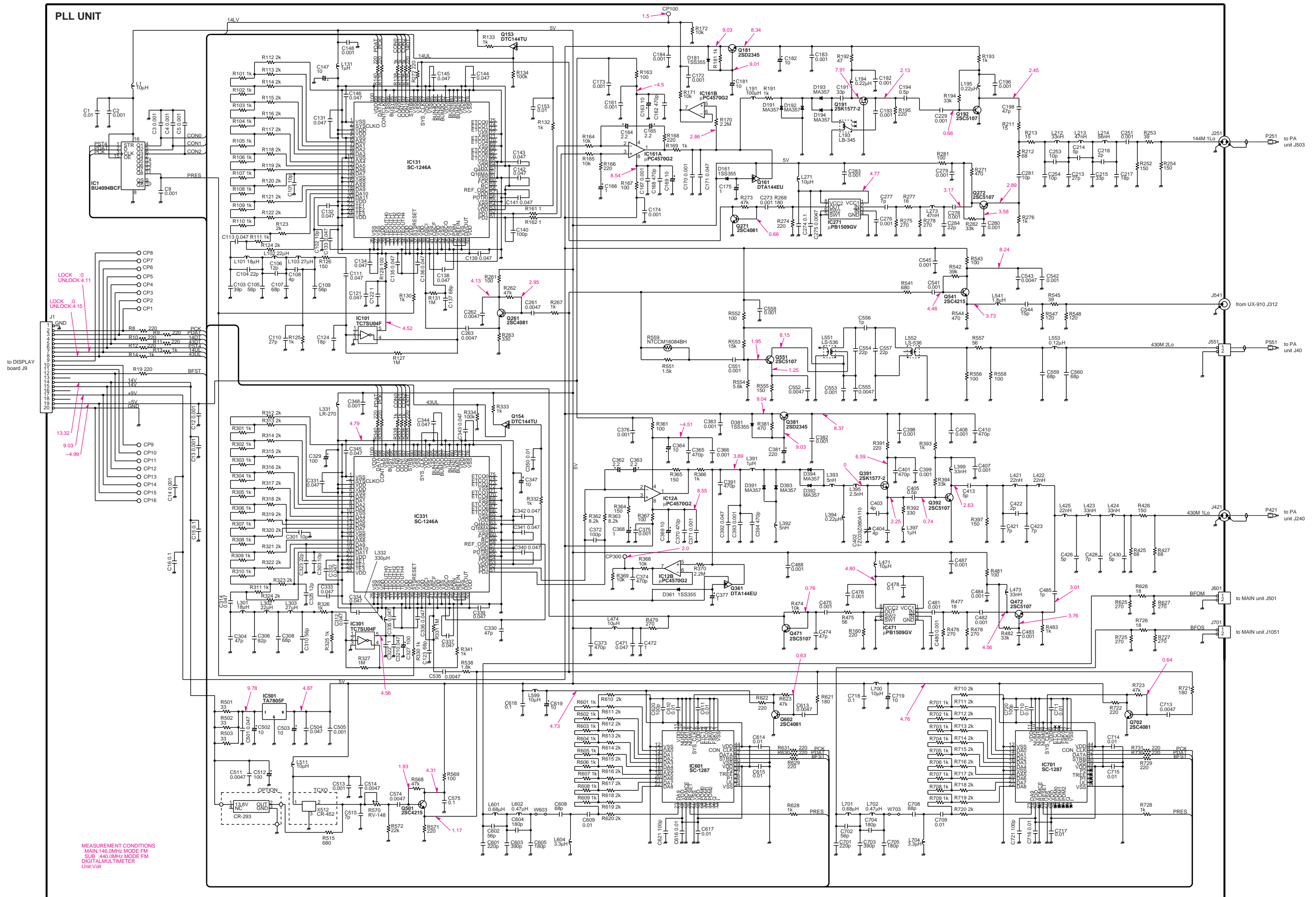

12-3 PA UNIT (1)

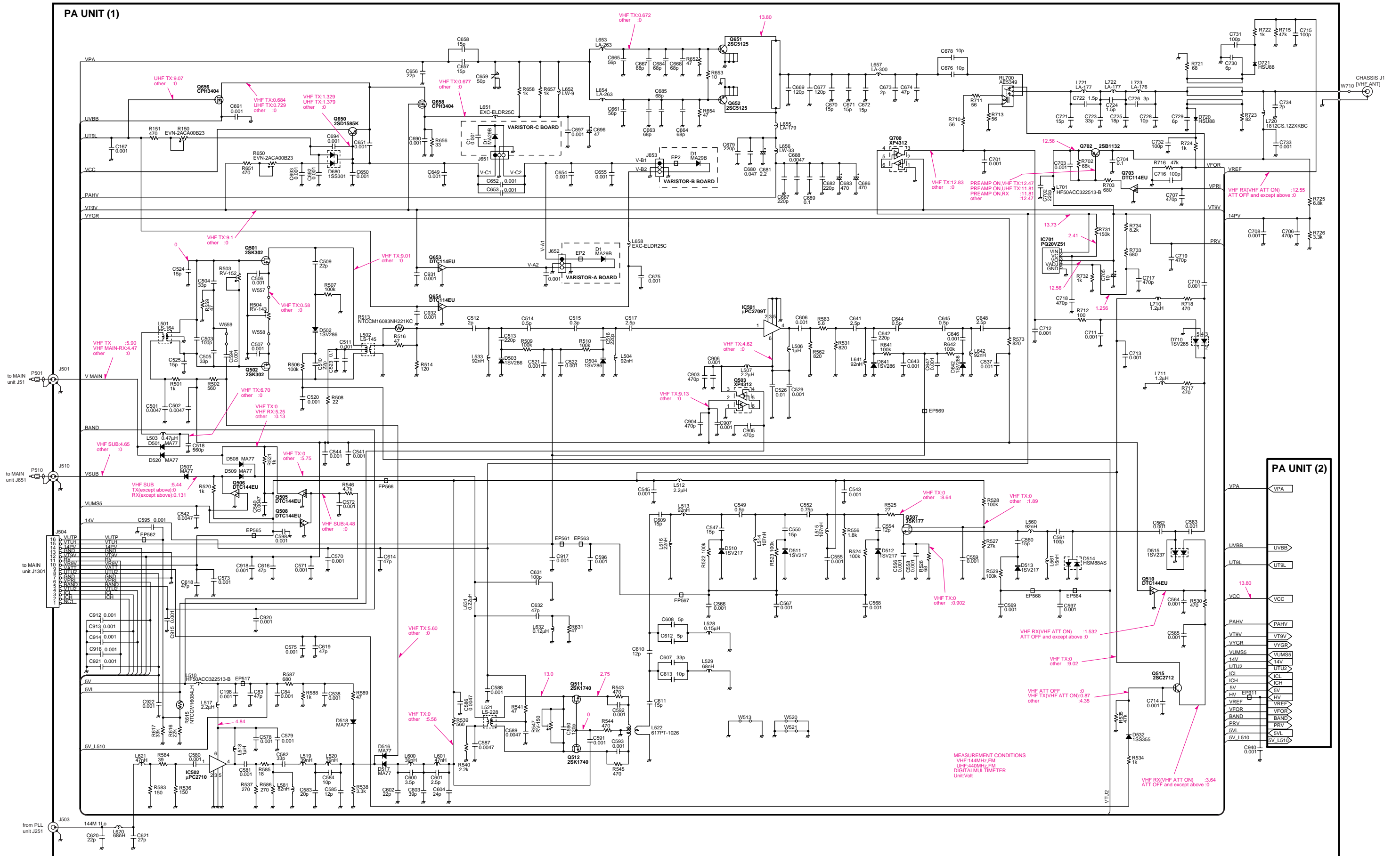

12-4 PA UNIT (2)

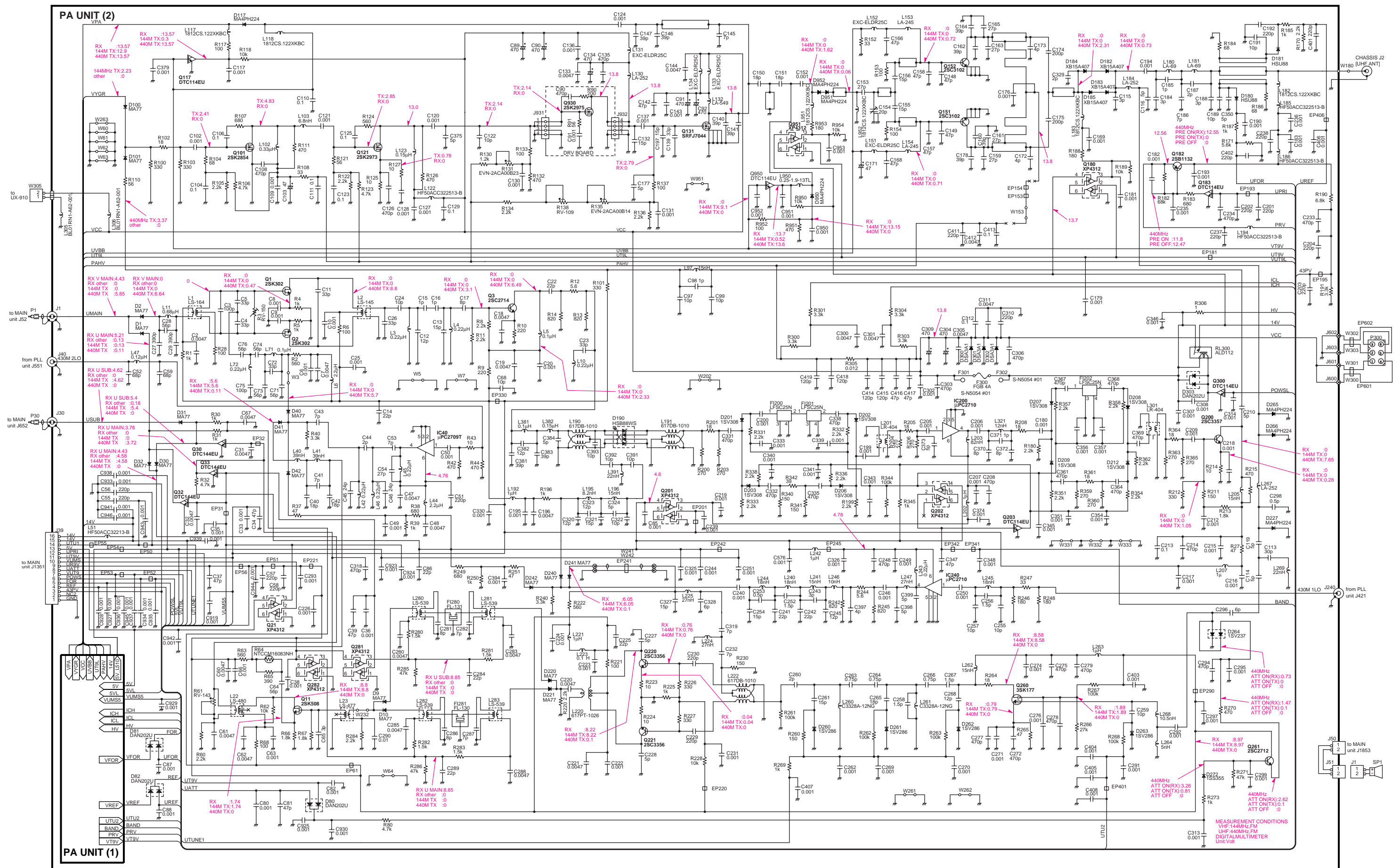

12-5 MAIN UNIT (1)

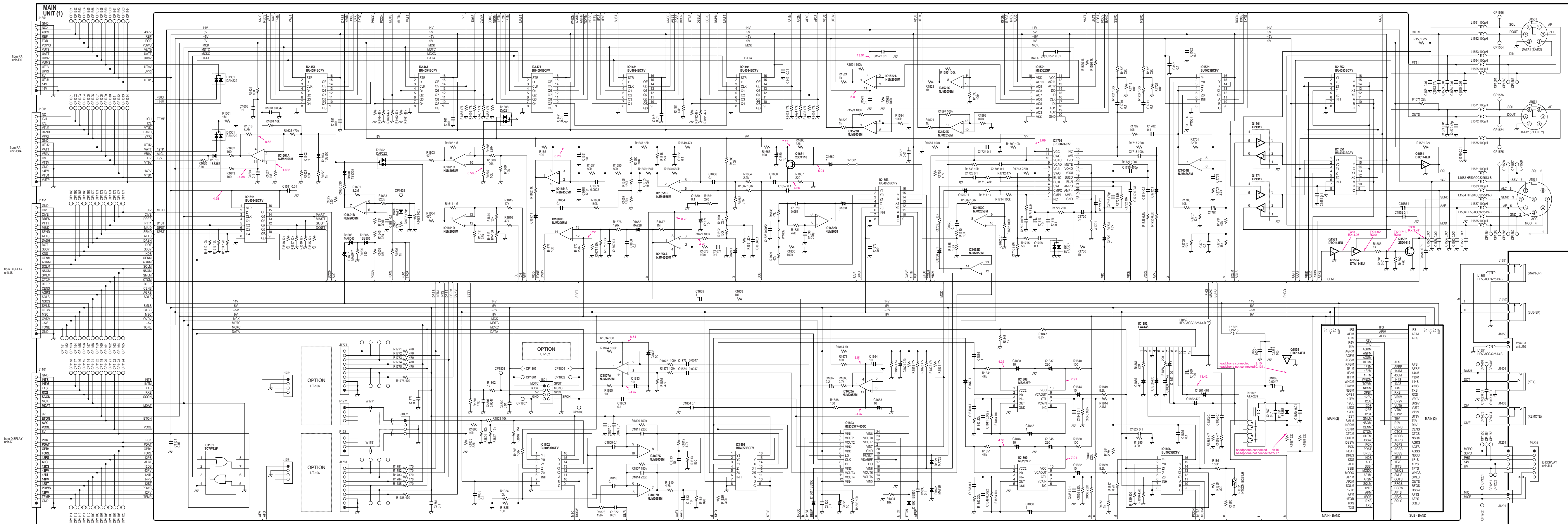

12-6 MAIN UNIT (2)

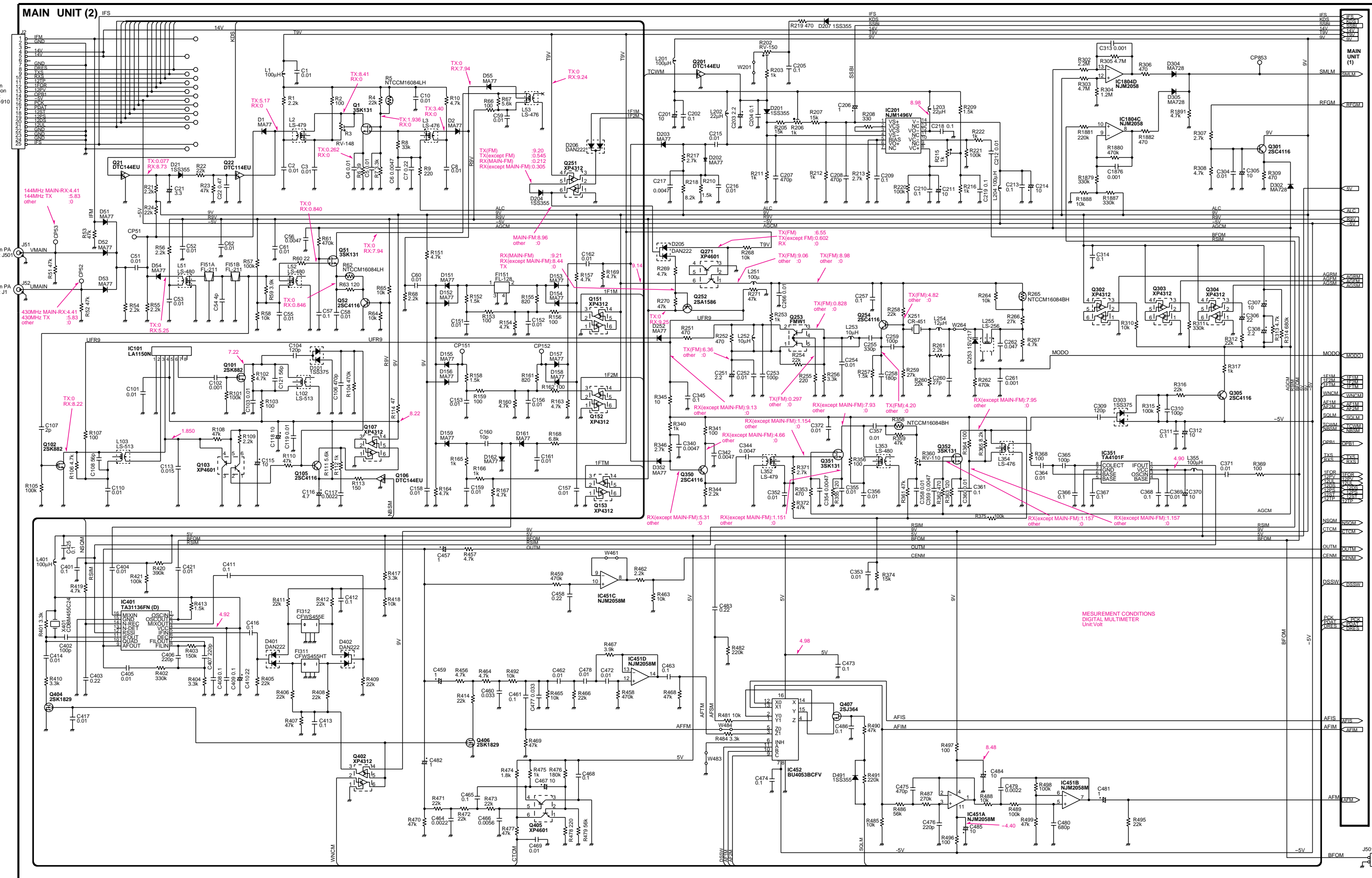

12-7 MAIN UNIT (3)

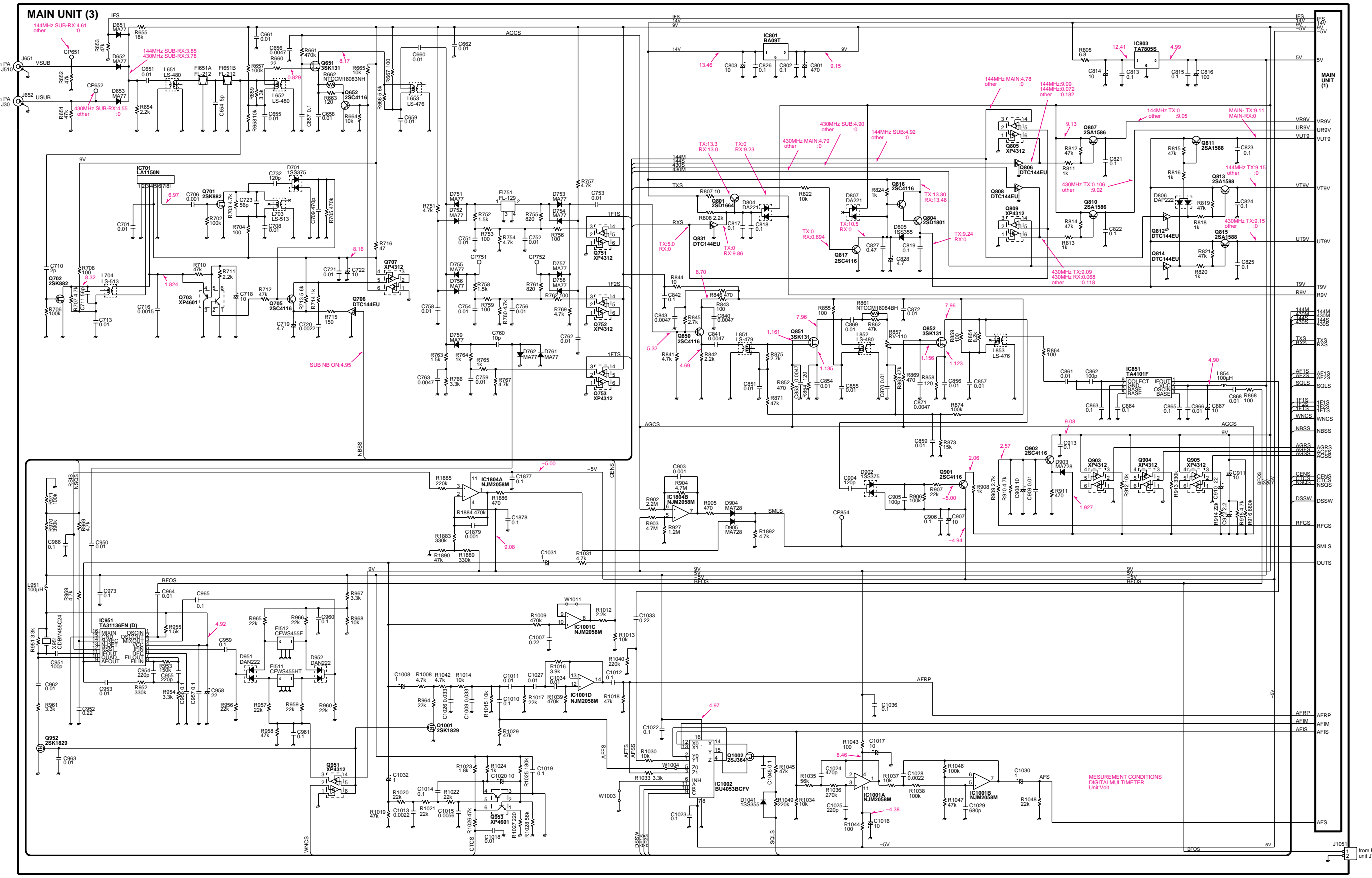

12-8 UX-910 MAIN UNIT (1)

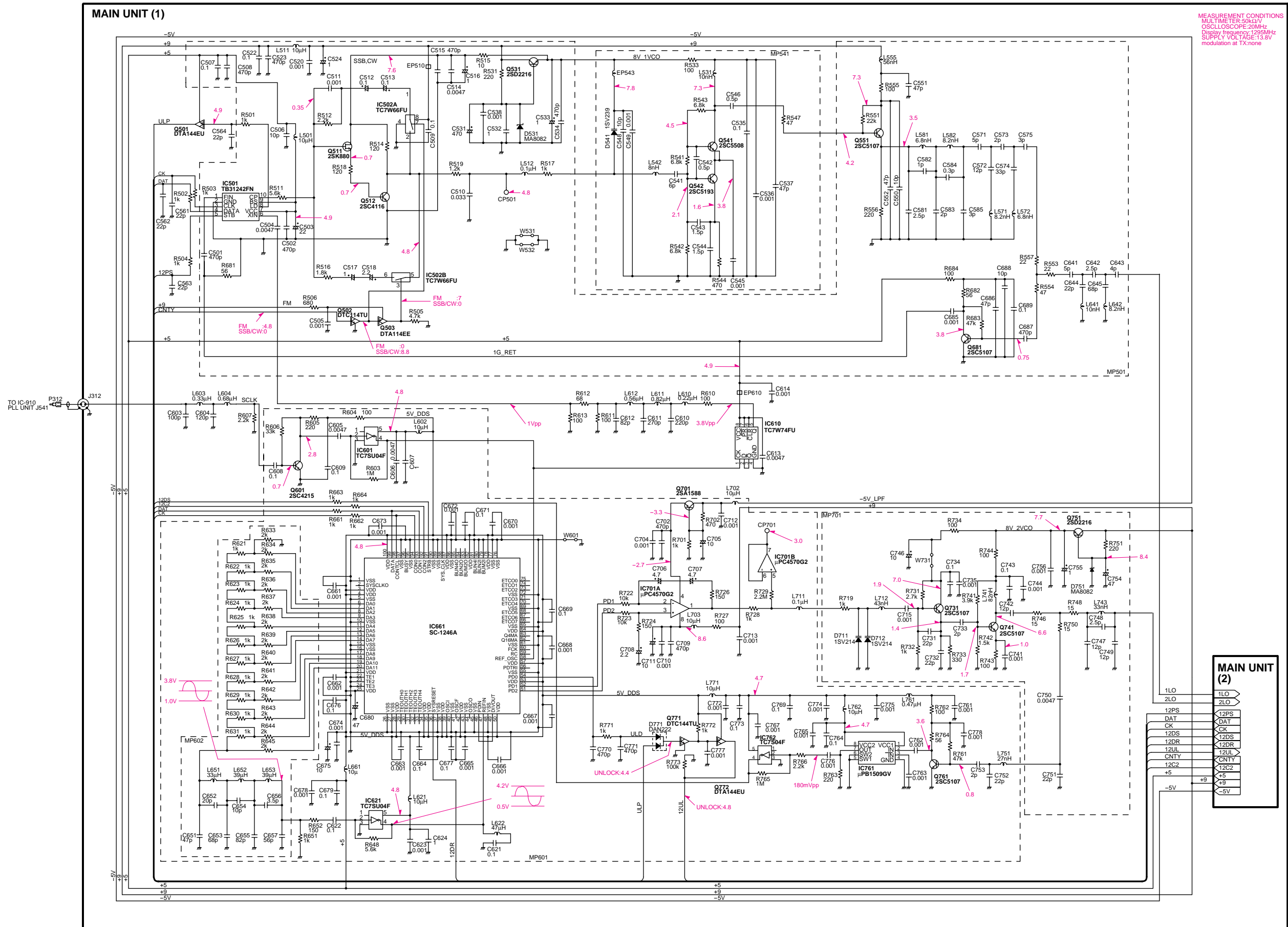

12-9 UX-910 MAIN UNIT (2)

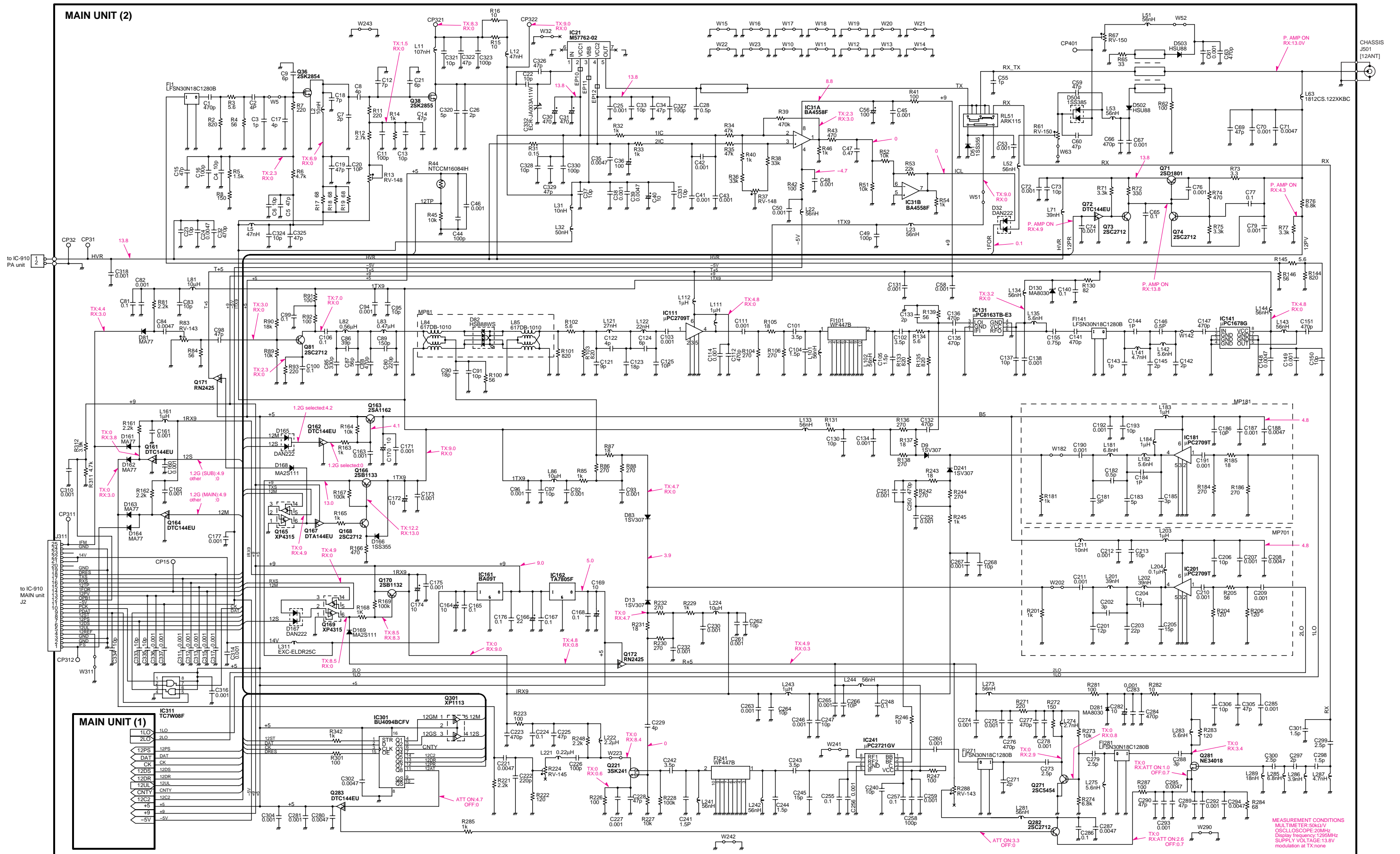

MEASUREMENT CONDITIONS
 MULTIMETER: 30kV
 OSCILLOSCOPE: 20MHz
 Display frequency: 125MHz
 SUPPLY VOLTAGE: 13.8V
 modulation at TX:none

Icom Inc.

1-1-32, Kamiminami, Hirano-ku, Osaka 547-0003, Japan
Phone : 06 6793 5302
Fax : 06 6793 0013
URL : <http://www.icom.co.jp/world/index.html>

Icom America Inc.

<Corporate Headquarters>
2380 116th Avenue N.E., Bellevue, WA 98004, U.S.A.
Phone : (425) 454-8155 Fax : (425) 454-1509
URL : <http://www.icomamerica.com>
<Customer Service>
Phone : (425) 454-7619

Icom Canada

Glenwood Centre #150-6165
Highway 17 Delta, B.C., V4K 5B8, Canada
Phone : (604) 952-4266 Fax : (604) 952-0090
URL : <http://www.icomcanada.com>

Icom (Australia) Pty. Ltd.

A.B.N. 88 006 092 575
290-294 Albert Street, Brunswick, Victoria, 3056, Australia
Phone : 03 9387 0666 Fax : 03 9387 0022
URL : <http://www.icom.net.au>

Icom New Zealand

146A Harris Road, East Tamaki,
Auckland, New Zealand
Phone : 09 274 4062 Fax : 09 274 4708
URL : <http://www.icom.co.nz>

Icom (Europe) GmbH

Communication Equipment
Himmelgeister Str. 100, D-40225 Düsseldorf, Germany
Phone : 0211 346047 Fax : 0211 333639
URL : <http://www.icomeurope.com>

Icom Spain S.L

Ctra. de Gracia a Manresa Km. 14,750
08190 Sant Cugat del Valles Barcelona, SPAIN
Phone : (93) 590 26 70 Fax : (93) 589 04 46
URL : <http://www.icomspain.com>

Icom (UK) Ltd.

Unit 9, Sea St., Herne Bay, Kent, CT6 8LD, U.K.
Phone : 01227 741741 Fax : 01227 741742
URL : <http://www.icomuk.co.uk>

Icom France S.a

Zac de la Plaine, Rue Brindejonn des Moulinais
BP 5804, 31505 Toulouse Cedex, France
Phone : 561 36 03 03 Fax : 561 36 03 00
URL : <http://www.icom-france.com>

Asia Icom Inc.

6F No. 68, Sec. 1 Cheng-Teh Road, Taipei, Taiwan, R.O.C.
Phone : (02) 2559 1899 Fax : (02) 2559 1874

Count on us!

Icom Inc.

1-1-32, Kamiminami, Hirano-ku Osaka 547-0003, Japan

S-13714HZ-C1

© 2001 Icom Inc.