

ALINCO

WIDE BAND COMMUNICATION RECEIVER

DJ-X30T/E/K

Instruction Manual

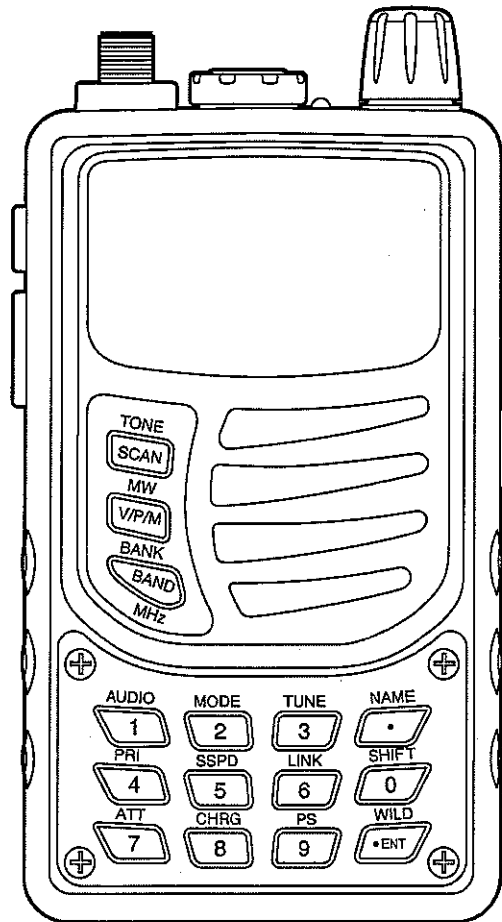

Thank you for purchasing your new Alinco receiver. This instruction manual contains important safety and operating instructions. Please read this manual carefully before using the product and keep it for future reference.

ALINCO, INC

NOTICE / Compliance Information Statement

This equipment has been tested and found to comply with the limits for a Class B digital device, pursuant to part 15 of the FCC Rules.

These limits are designed to provide reasonable protection against harmful interference in a residential installation.

This equipment generates, uses, and can radiate radio frequency energy and, if not installed and used in accordance with the instruction manual, may cause harmful interference to radio communications. However, there is no guarantee that interference will not occur in a particular installation. If this equipment does cause harmful interference to radio or television modulation, which can be determined by turning the equipment off and on, the user is encouraged to try to correct the interference by one or more of the following measures:

- Reorient or relocate the receiving antenna.
- Increase the separation between the equipment and receiver.
- Connect the equipment into an outlet on a circuit different from that to which the receiver is connected.
- Consult the dealer or an experienced radio/TV technician for help.



Tested to Comply
With FCC Standards
FOR HOME OR OFFICE USE

Information in this document is subject to change without notice or obligation. All brand names and trademarks are the property of their respective owners. Alinco cannot be liable for pictorial or typographical inaccuracies. Some parts, options and/or accessories are unavailable in certain areas. Changes or modifications not expressly approved by the party responsible for compliance could void the user's authority to operate the equipment.

Wide Band Communication Receiver DJ-X30T

This device complies with Part 15 of the FCC Rules. Operation is subject to the following two conditions: (1) This device may not cause harmful interference, and (2) this device must accept any interference received, including interference that may cause undesired operation.

Manufacturer:

ALINCO, INC.
Shin-Dai building 9th Floor 2-6, 1-Chome
Dojimahama, Kita-ku, Osaka 530-0004 JAPAN



Conformity Information

Alinco, Inc. Electronics Division hereby declare on our sole responsibility that the product(s) listed below comply the essential requirements of the Directive 1999/5/EC, The council of 3/9/99 on Radio Equipment and Telecommunication Terminal Equipment and the mutual recognition of their conformity and with the provisions of Annex, after having performed the required measurements at Notified Bodies per Standards, and relative certificate(s) or document(s) can be reviewed at <http://www.alinco.com/Ce/>

DJ-X30E: Wide Band Communication Receiver 0.1 - 1299.995MHz

DJ-X30EGR: Portable broadcast/hamband Receiver 0.522 - 1.620MHz
53.75 - 67.75MHz
87.6 - 107.9MHz
144 - 145.995MHz
180.75 - 229.75MHz
430 - 439.995MHz
476.75 - 860.75MHz
1260 - 1299.995MHz





DJ-X30E is authorized for use in all EU and EFTA member states except for Greece.



DJ-X30EGR is authorized for use in all EU and EFTA member states.

Copyright © All rights reserved. No part of this document may be reproduced, copied, translated or transcribed in any form or by any means without the prior written permission of Alinco. Inc., Osaka, Japan, English Edition Printed in Japan.

Warning





To prevent any hazard during operation of Alinco's radio product, in this manual and on the product you may find symbols shown below. Please read and understand the meanings of these symbols before starting to use the product.





 Danger	This symbol is intended to alert the user to an immediate danger that may cause loss of life and property if the user disregards the warning.
 Alert	This symbol is intended to alert the user to a possible hazard that may cause loss of life and property if the user disregards the warning.
 Caution	This symbol is intended to alert the user to a possible hazard that may cause loss of property or injure the user if the warning is disregarded.

	Alert symbol. An explanation is given.
	Warning symbol. An explanation is given.
	Instruction symbol. An explanation is given.





Alert

■ Environment and condition of use





-  It is recommended that you check local traffic regulations regarding the use of radio equipment while driving. Some countries prohibit or apply restrictions for the operation of radios and mobile- phones while driving.
-  Do not use this product in close proximity to other electronic devices, especially medical ones. It may cause interference to those devices.
-  Keep the radio out of the reach of children.
-  In case a liquid leaks from the product, do not touch it. It may damage your skin. Rinse with plenty of cold water if the liquid contacted your skin.
-  Never operate this product in facilities where radio products are prohibited for use such as aboard aircraft, in airports, in ports, within or near the operating area of business wireless stations or their relay stations.

-  Use of this product may be prohibited or illegal outside of your country. Be informed in advance when you travel.
-  The manufacturer declines any responsibilities against loss of life and/or property due to a failure of this product when used to perform important tasks like life-guarding, surveillance, and rescue.
-  Risk of explosion if battery is replaced with an incorrect type. Dispose of, or recycle used batteries according to your local regulations.
-  The manufacturer declines any responsibilities against loss of life and property due to a failure of this product when used with or as a part of a device made by third parties.
-  Use of third party accessory may result in damage to this product. It will void our warranty for repair.

■ Handling this product







-  Be sure to reduce the audio output level to minimum before using an earphone or a headset. Excessive audio may damage hearing.
-  Do not open the unit without permission or instruction from the manufacturer. Unauthorized modification or repair may result in electric shock, fire and/or malfunction.
-  Do not operate this product in a wet place such as shower room. It may result in electric shock, fire and/or malfunction.
-  Do not place the product in a container carrying conductive materials, such as water or metal in close proximity to the product. A short-circuit to the product may result in electric shock, fire and/or malfunction.

■ About chargers



-  Do not use adapters other than having the specified voltage. It may result in electric shock, fire and/or malfunction.
-  Do not plug multiple devices using an adapter into a single wall outlet. It may result in overheating and/or fire.
-  Do not handle adapter with a wet hand. It may result in electric shock.
-  Securely plug the adapter into the wall outlet. Insecure installation may result in short-circuit, electronic shock and/or fire.
-  Do not use the adapter if the plug or socket contacts are dirty. Overheating and/or short-circuiting may result in fire, electric shock and/or damage to the product.

Warning

■ About power supply

-  Use only appropriate, reliable power supply of correct voltage and capacity.
-  Do not connect cables in reverse polarity. It may result in electric shock, fire and/or malfunction.
-  Do not plug multiple devices including the power supply into a single wall outlet. It may result in overheating and/or fire.
-  Do not handle a power supply with a wet hand. It may result in electric shock.
-  Securely plug the power supply to the wall outlet. Insecure installation may result in short-circuiting, electronic shock and/or fire.
-  Do not plug the power supply into the wall socket if the contacts are dirty. Short-circuit and/or overheating may result in fire, electric shock and/or damage to the product.
-  Do not modify or remove fuse-assembly from the DC cable. It may result in fire, electric shock and/or damage to the product.

■ Cigar-lighter cable

-  Do not use the cable at any other than the specified voltage. It may result in electric shock, fire and/or malfunction.
-  Do not handle cigar cable with a wet hand. It may result in electric shock.

■ In case of emergency

In case of the following situation(s), please turn off the product, switch off the source of power, then remove or unplug the power-cord. Please contact your local dealer of this product for service and assistance. Do not use the product until the trouble is resolved.

Do not try to troubleshoot the problem by yourself.





- When a strange sound, smoke and/or strange odor comes out of the product.
- When the product is dropped or the case is broken or cracked.
- When a liquid penetrated inside.
- When a power cord (including DC cables, AC cables and adapters) is damaged.

-  For your safety, turn off then remove all related AC lines to the product and its accessories from the wall outlet if a thunderstorm is likely.





■ Maintenance

-  Do not open the unit and its accessories. Please consult with your local dealer of this product for service and assistance.





 **Caution****■ Environment and condition of use**

-  Do not use the product in proximity to a TV or a radio. It may cause interference or receive interference.
-  Do not install in a humid, dusty or insufficiently ventilated place. It may result in electric shock, fire and/or malfunction.
-  Do not install in an unstable or vibrating position. It may result in electric shock, fire and/or malfunction when/if the product falls to the ground.
-  Do not install the product in proximity to a source of heat and humidity such as a heater or a stove. Avoid placing the unit in direct sunlight.
-  Be cautious of a dew formation. Please completely dry the product before use when it happens.

■ About transceiver

-  Be cautious of the whip antenna when carried in your shirt-pocket etc. It may make contact with your eye and cause injury.
-  Do not connect devices other than specified ones to the jacks and ports on the product. It may result in damage to the devices.
-  Turn off and remove the power source (AC cable, DC cable, battery, cigar cable, charger adapter etc.) from the product when the product is not in use for extended period of time or in case of maintenance.
-  Never pull the cord alone when you unplug AC cable from the wall outlet.
-  Use a clean, dry cloth to wipe off dirt and condensation from the surface of the product. Never use thinner or benzene for cleaning.

■ About power supply

-  Use only reliable power supply of specific DC output range and be mindful of the polarity of the cable and DC-jack.
-  Always turn off the power supply when connecting or disconnecting the cables.
-  When using an external antenna, make sure that the antenna ground is not common with the ground of the power supply.
-  European users: When a unit is powered from an external DC power source (adapter, power supply, cigar-plug etc.), make sure that this power supply has approval to the level of IEC/EN 60950-1.

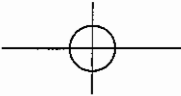

Warning

■ Lightning

Any person is not safe outdoor during thunderstorm and lightning. This condition is getting worse if somebody keeps a hand-held radio; chances of being hit by lightning are doubled since lightning may hit a radio antenna as well. At this time, there is no hand-held radio having any kind of protection against lightning current (which is higher than 10 kA.). Note also that no car provides adequate protection of its passengers or drivers against lightning as well. Therefore, Alinco will not take responsibility for any danger associated with using its hand-held radios outdoor or inside the car during lightning.

■ Notice to California resident users

The Safe Drinking Water and Toxic Enforcement Act of 1986 of the State of California determines that lead and cadmium are considered carcinogens and reproductive toxicants. The product that comes with this manual is free from dangerous materials such as lead and cadmium as per RoHS order of EU.

■ Limited Power Source

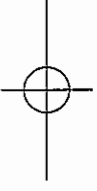
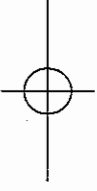

Adhering to the requirement of the following warning ensures compliance of the receiver with the safety standard for information technology equipment, EN 60950-1. Please note that the receiver enclosure only provides mechanical protection of its internal parts; it will not contain a fire within the device if the fire starts under certain fault conditions. Alinco will not take responsibility for any fire hazard associated with powering the receiver or charging its batteries using a power source which does not belong to the limited power sources in the meaning of EN 60950-1. Excluded from possible use with the receiver are most car cigarette lighters and some DC (AC/DC) power supplies. Make sure that the power supply used with the receiver is a limited power source.

Introduction

Thank you very much for purchasing this excellent Alinco receiver. Our products are ranked among the finest in the world. This radio has been manufactured with state of the art technology and it has been tested carefully at our factory. It is designed to operate to your satisfaction for many years under normal use.

PLEASE READ THIS MANUAL COMPLETELY TO LEARN ALL THE FUNCTIONS THE PRODUCT OFFERS. WE MADE EVERY ATTEMPT TO WRITE THIS MANUAL TO BE AS COMPREHENSIVE AND EASY TO UNDERSTAND AS POSSIBLE. IT IS IMPORTANT TO NOTE THAT SOME OF THE OPERATIONS MAY BE EXPLAINED IN RELATION TO INFORMATION IN PREVIOUS CHAPTERS. BY READING JUST ONE PART OF THE MANUAL, YOU RISK NOT UNDERSTANDING THE COMPLETE EXPLANATION OF THE FUNCTION.

Table of Contents

1. Features	13
2. Accessory List	14
3. Using Accessories	15
3-1 Attaching/Detaching the External Antenna	15
3-2 Attaching the Belt Clip.....	15
3-3 Attaching the Hand Strap	16
3-4 Changing the Key Cover and Related Precautions	16
3-5 Installing Batteries and Related Precautions	17
3-6 Using the AC Adapter (Optional: EDC-139/120V, EDC-140/220V).....	19
3-7 Using the Optional Trickle Charger and Related Precautions	20
3-7-1 Connecting the trickle charger	20
3-7-2 Charging the battery pack	20
4. Names and Functions of Parts	22
4-1 Names and Functions of Receiver Parts.....	22
4-1-1 Top/Front panel	22
4-1-2 Side panel.....	23
4-1-3 Key operations	23
4-2 LCD Display	26
5. Basic Operation	27
5-1 Turning the Power ON	27
5-2 Adjusting Volume Level	27
5-3 Adjusting Squelch Level.....	28
5-3-1 Operating procedure	28
5-3-2 Monitor function	29
5-3-3 Mute function	29
5-4 Operating Modes.....	30
5-5 Frequency Settings.....	30
5-5-1 Setting frequencies in VFO mode.....	30
5-5-2 Specifying tuning step frequencies	31
5-5-3 10 MHz/1 MHz UP/DOWN operation	33
5-5-4 Setting frequencies in Preset mode	34
5-5-5 Setting frequencies in Memory mode	34
5-6 Memory Mode	35
5-6-1 Memory types and usage	35
5-6-2 Programming a memory channel	36
5-6-3 Deleting a memory channel	38

6. Useful Functions	39
6-1 Scanning Function	39
6-1-1 VFO scan	40
6-1-2 Preset scan	40
6-1-3 Memory scan	41
6-1-4 Programmed scan	42
6-2 Memory Skip Function	42
6-3 Key-lock Function	43
6-3-1 Key-lock procedure	43
6-3-2 Available operations while the Key-lock is active	43
6-4 Tone Squelch/Reverse Tone Squelch Function	44
6-5 Descrambling Function (E-Version only)	45
6-6 Tone Scan Function	46
7. Useful Functions/Operations When Key Pad is Installed	47
7-1 Basic Key Pad Operation	47
7-2 Audio Quality Switching Function	48
7-3 Modulation Mode Switching Function	48
7-4 Shortwave Tuning Function	49
7-5 Memory Naming Function	50
7-6 Priority Monitoring Function	51
7-7 Scan Speed Switching Function	53
7-8 Group Setting/Checking Function	54
7-8-1 Setting a group	54
7-8-2 Checking banks in a group	55
7-9 Frequency Shift Function	55
7-9-1 Setting the Frequency Shift function	55
7-9-2 Operation procedure	56
7-10 Attenuator (ATT) Function Setting	56
7-11 Charging Function Setting	57
7-12 Quick Programmed Scan	57
8. Set Mode Configurations	58
8-1 Configuring Values/Parameters of Set Mode Menu Items	58
8-2 Set Mode Configurations	59
8-2-1 Attenuator (ATT) function setting	59
8-2-2 Earphone Antenna setting	59
8-2-3 AM Radio Bar-antenna setting	60
8-2-4 Shortwave Bar-antenna setting	60
8-2-5 Lamp Operation setting	61
8-2-6 Scan Type Switching setting	61
8-2-7 Priority Channel selection	62
8-2-8 Priority Monitoring interval setting	62
8-2-9 Priority Monitoring duration setting	62
8-2-10 Band Transition setting	63
8-2-11 APO function setting	63
8-2-12 Battery-save function setting	64
8-2-13 Beep deactivation setting	64
8-2-14 Bell function setting	65
8-2-15 Monitor Key Operation setting	65



Table of Contents

8-2-16 Monitor/Mute function setting	66
8-2-17 Charging function setting	66
8-2-18 Charging time setting	67
8-2-19 Set Mode cancel time setting	67
8-2-20 Write-protect (memory protection) function setting	68
8-2-21 Skip-scan Operation setting.....	69
8-2-22 Wild Key assignment setting	69
8-2-23 Function assignment for remote controller buttons	71
8-2-24 Quick programmed scan channel selection	72
9. Channel Display Mode	73
10. Using the Optional Remote Controller	74
10-1 Using the Remote Controller EDS-12	74
10-1-1 Top/Bottom/Front panels	74
10-1-2 Side panel	74
10-2 Connecting the Remote Controller.....	75
10-3 Remote Controller Functions	75
11. Cable-clone and PC Connection Functions	76
11-1 Cable Connection (An optional cable necessary)	76
11-2 Receiving Data	77
11-3 Transferring Data	78
12. Reset Function	79
12-1 Reset Procedure	79
12-2 Default Settings	80
13. Maintenance and Reference	82
13-1 Troubleshooting.....	82
13-2 Optional Accessories List.....	83
13-3 Table of Available CTCSS Tones	83
14. Index	84
15. Specifications.....	86

1. Features

1

The DJ-X30 is a multifunctional receiver which receives a wide range of radio signals from low-frequency (LF) signals to ultra-high-frequency (UHF) signals. It provides the following features:

- 1** Receives a wide range of frequencies - between 0.100 and 1299.995 MHz - including aviation radio and business communication frequencies. *
- 2** Built-in bar-antenna receives AM radio and shortwave broadcasts, eliminating the need to attach an external antenna.
- 3** Earphone cord can be used as an antenna to receive FM broadcast and other stronger signals without using an external antenna.
- 4** Use the key pad for advanced operation, or replace it with the key pad cover for simple operation.
- 5** Automatic input switching. By connecting the optional remote controller to the earphone jack and connecting an MP3 player or other portable audio device to the controller, you can listen to music under normal conditions and hear receiver messages when the DJ-X30 receives any signals.
- 6** Cable-clone function allows you to copy settings and various data among the DJ-X30. PC Connection function allows you to edit settings and data via a PC.
- 7** Tone-squelch function even supports reverse tones which are used in business communications.
- 8** Scan speed is selectable from 5 levels. Select a faster scan speed to detect strong signals, and select a slower scan speed to detect weak signals.
- 9** Wild Key function allows you to quickly jump to frequently used Set mode functions of your choice.

*Restrictions apply to T and EGR models. Please refer to the specification on P. 86 for T, P. 3 for EGR.

2. Accessory List

2

The package of the DJ-X30 contains the following items. Check that all items are included in your package before using the receiver.

- Instruction Manual (this manual)
- Whip antenna (SMA)
- Face-panel
- Rubber-cushion
- Belt clip
- Hand strap
- Screws (One for the belt clip, and two as spares for the key cover)

Standard accessory may vary depending on the model you have purchased. Please consult with your Alinco dealer of the details before purchase.

3. Using Accessories

3-1 Attaching/Detaching the External Antenna

3

- 1** Hold the antenna at its base and slowly rotate it clockwise (to the right).

When you cannot rotate the antenna further, check that it is securely attached to the receiver.

- 2** To remove the antenna, slowly rotate it counterclockwise (to the left).

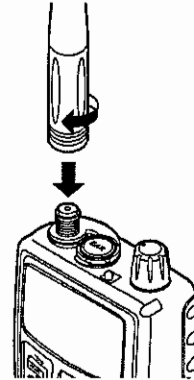

3-2 Attaching the Belt Clip

- 1** Align the belt clip with the groove at the rear of the receiver.
- 2** Insert the screw into the hole on the clip and rotate it clockwise (to the right).

When you cannot rotate the screw further, check that the clip is securely attached to the receiver.

- 3** To remove the clip, rotate the screw counterclockwise (to the left).

* The screw may become loose during use. Check the tightness of the screw from time to time.

The clip is considered as a consuming part and spares are available from your Alinco dealer.

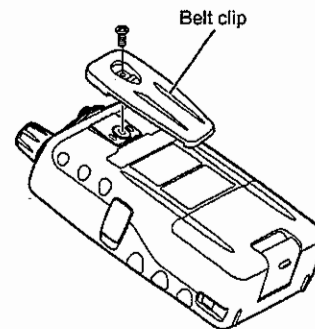

3-3 Attaching the Hand Strap

- 1** Attach the hand strap by drawing it through the hole on the belt clip as shown in the figure.

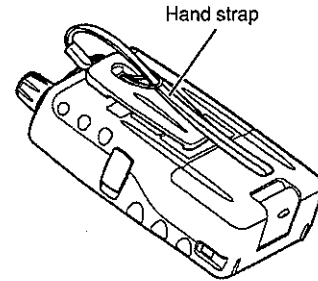

3

3-4 Changing the Key Cover and Related Precautions

- 1** Be sure to turn OFF the receiver before starting the following steps.

- 2** View the receiver from the front, and remove the four screws shown in the figure.

Be careful not to lose the screws. (The package of the DJ-X30 includes spare screws as insurance against the loss of the screws. These should be stored separately.)

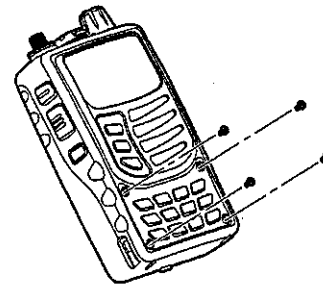

- 3** Remove the key pad cover.

When it is difficult to remove the cover, apply a strip of cellophane tape to the cover and it will lift off easily.

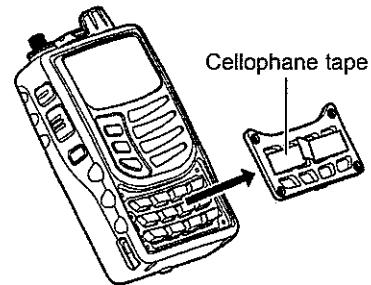

- 4** Remove the key pad.

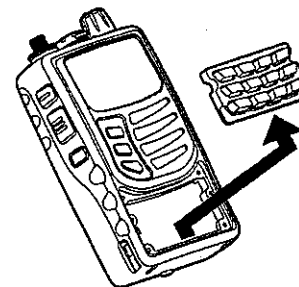

- 5** Place the rubber cushion.

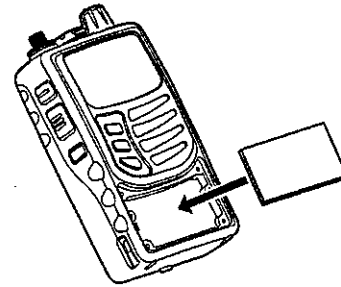

3

- 6** Place the face-panel.
7 Secure the panel with the four screws you removed previously.
 Be careful not to overtighten the screws as this may damage the panel.

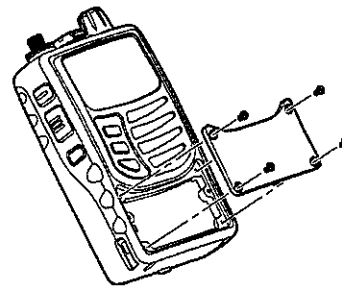

3-5 Installing Batteries and Related Precautions

- 1** Release the lock of the battery compartment cover and open it.
 Be careful not to lose the cover.

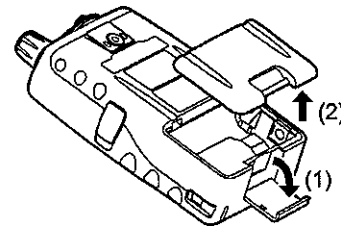

- 2** Insert two batteries checking that they are orientated correctly with the + and - indicators inside the compartment.

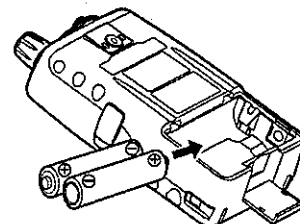

• Be careful not to insert the batteries incorrectly as this may damage the receiver, or cause overheating or leakage.

3 Close the cover and lock it.

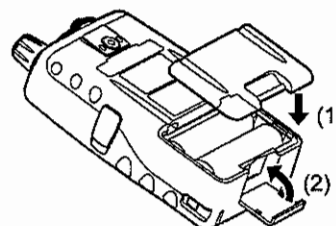

Check that the cover has closed securely.

The DJ-X30 can be used with Ni-MH battery pack, AA-size alkaline dry cell batteries or similar commercially-available batteries.



3

• Battery indicator

When the remaining battery power becomes low, the  appears on the LCD. When the power decreases further, the icon changes to .

When this icon appears, the Ni-MH battery pack should be charged, or if alkaline dry cell batteries are being used, they should be replaced with new ones.

• Cautions when using the Ni-MH battery pack

- The optional Ni-MH battery pack is not fully charged when shipped. You will need to charge it before use.
- The battery pack must be charged within the temperature range of 0 to 40°C (32 to 104°F).
- Do not modify or dismantle the battery pack. Do not throw it into fire or water. These actions are dangerous.
- Do not short-circuit the battery pack. This may damage the receiver, and may cause burns by the heat generated from the battery pack.
- Do not charge the battery pack for an unnecessarily long time (i.e. avoid overcharging). This may deteriorate battery performance.
- The battery pack should be stored in a dry place where the temperature range is between -20 and +45°C (-4 and 113°F). Storing the battery pack in locations with high humidity or temperatures outside the proper range may cause the battery pack to leak or rust.
- When the battery pack exhausts extremely fast even when it has been charged for the specified time, it may have reached its end of life. Replace the battery pack with a new one.
- To protect the environment, do not dispose of the exhausted battery pack but take it to a battery recycle center in your area.
- Due to its characteristics, the Ni-MH battery pack may deteriorate and may not be able to be charged after it is left for about six months without charging. If you intend not to use the receiver for a long time, fully charge the battery pack, remove it from the receiver, and store it separately. Be sure to charge it at least once every six months.
- The Ni-MH battery pack is a consumable article and is not covered by the warranty of the receiver.

- **Prevent Short Circuiting the Battery Pack**

Be extra cautious when carrying the rechargeable battery pack; short circuiting will produce surge current possibly resulting in fire.

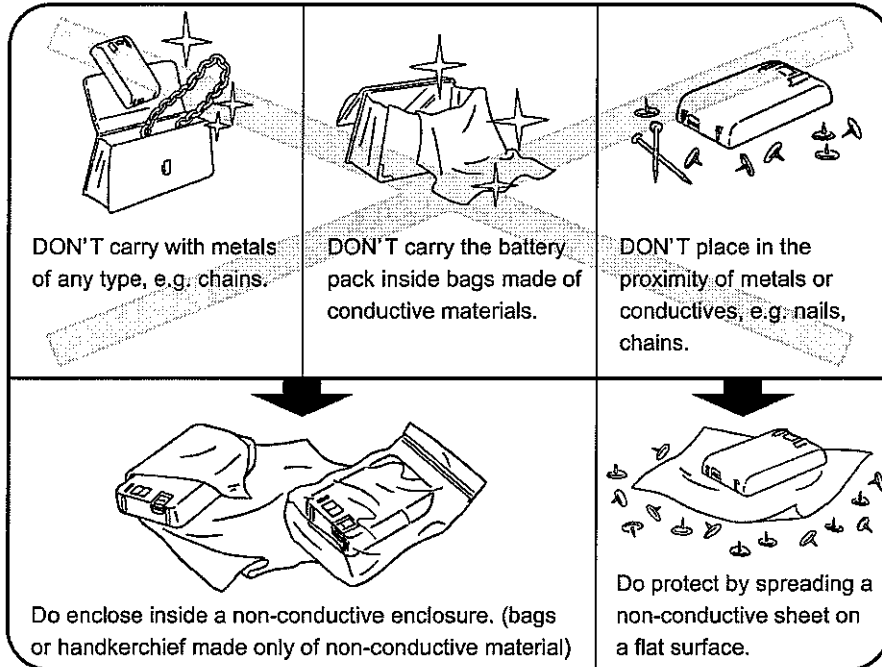

3

3-6 Using the AC Adapter (Optional: EDC-139/120V, EDC-140/220V)

- 1** Open the DC jack cover on the right side of the receiver.
- 2** Insert the plug of the AC adapter into the DC jack on the receiver.
- 3** Plug the AC adapter into a wall outlet.



CAUTION

• When not connecting the AC adapter to the receiver, close the DC jack cover to prevent the entry of dust.

3-7 Using the Optional Trickle Charger and Related Precautions

3-7-1 Connecting the trickle charger

3

- 1** Insert the plug of the AC adapter into the DC jack on the rear of the trickle charger.
- 2** Plug the AC adapter into a wall outlet.

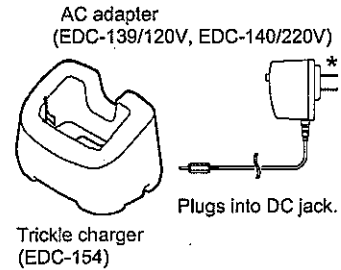

* The charger may look different depending on the model. (you have purchased)

3-7-2 Charging the battery pack

- 1** Install the Ni-MH battery pack in the receiver.
For the procedure of installing the battery pack, refer to "Installing Batteries and Related Precautions" (P. 17).
- 2** Turn ON the receiver.
- 3** Set the Charging function of the Set mode to ON.
The default is OFF.
Refer to P. 66 for setting.
- 4** Turn OFF the receiver.
- 5** Place the receiver on the trickle charger.

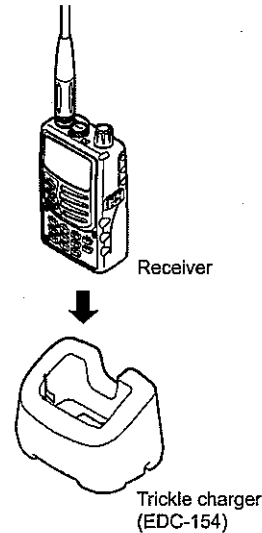

- 6** When charging starts, the RX lamp illuminates in red.
The low battery indicator on the LCD blinks, and the remaining charging time is displayed.

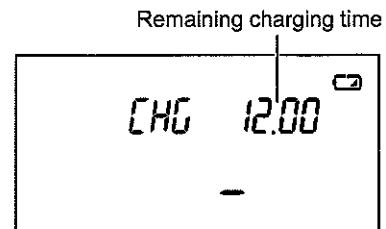

**MEMO**

- To prevent overcharging, charging automatically finishes after 12 hours (this time can be changed with the Set mode).
- Charging is possible even while operating the unit.
- The DJ-X30 can be charged directly from the AC adapter through the DC-Jack without using the trickle charger.
- Set the charging time according to the battery to be used. The time can be changed with the "Charging time setting" of the Set mode. (P. 67)
- * The charging time of the battery pack (EBP-57N) is about 10 hours.

**CAUTION**

- Never attempt charging when AA-size dry cell batteries are installed. This may cause leakage or other serious problems.
- When not using the AC adapter (EDC-139/EDC-140), you must unplug it from the wall outlet.
- Signals received while charging may occasionally be interrupted with noise. This is not a defect.
- When the Ni-MH battery pack is charged repeatedly before it becomes low, the battery deteriorates and cannot be fully charged. Do not charge battery pack unless the  is displayed on the LCD. If you are concerned about remaining battery power, carry spare batteries with you.

4. Names and Functions of Parts

4-1 Names and Functions of Receiver Parts

4-1-1 Top/Front panel

4

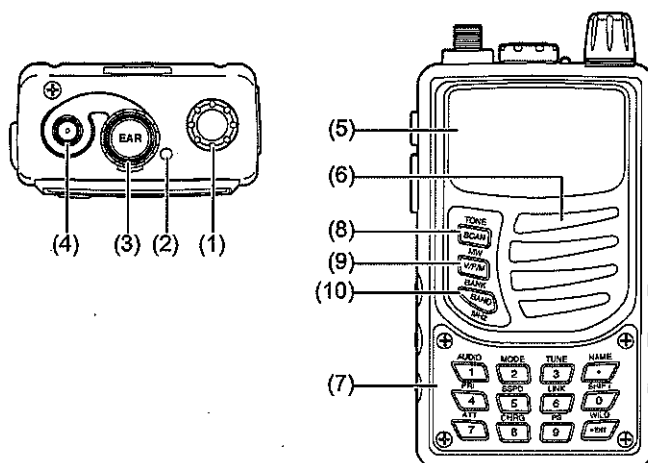

No.	Item	Description
(1)	Dial	Rotate the dial to change frequency. Press the dial once to adjust the volume level. Pressing this dial while the F is displayed switches the receiver to the Set mode.
(2)	RX lamp	This lamp illuminates in green while the squelch is open. The lamp illuminates in red while the receiver is charging.
(3)	Earphone jack	Used to connect an earphone or the optional cables, such as EDS-12, ERW-4C and ERW-7.
(4)	SMA antenna connector	Used to install the included whip antenna or an external antenna of your choice.
(5)	LCD	The status of the receiver is displayed. Refer to "LCD Display" for details.
(6)	Speaker	A low-profile, built-in speaker is provided.
(7)	Key pad	Use these keys to directly input a frequency or to directly jump to the Set mode. It is also possible to fully cover the keys for simple operation.
(8)	SCAN key	Used for scanning and Tone Squelch operations.
(9)	V/P/M key	Used to switch the operating mode.
(10)	BAND key	Used to switch the band, preset, or memory bank.

4-1-2 Side panel

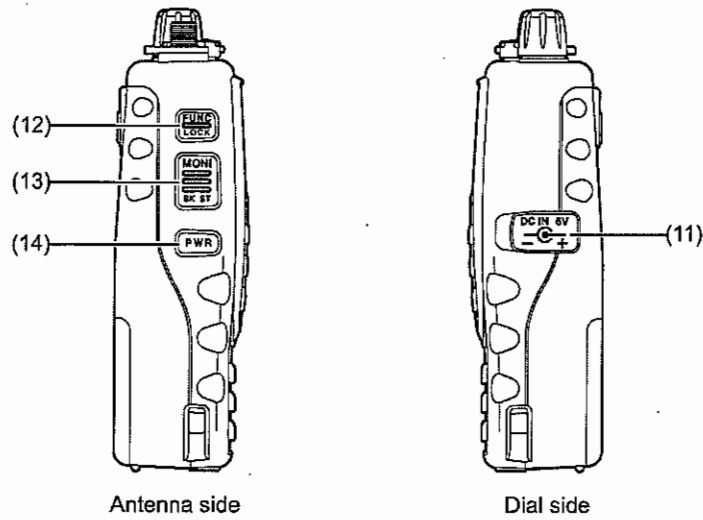

4

No.	Item	Description
(11)	DC jack	This jack is for plugging in an external power supply.
(12)	FUNC (Function) key	Use this key in combination with other keys to access various functions. Holding down this key activates/deactivates the quick Key-lock function.
(13)	MONI (Monitor) key	Press this key to open the squelch to receive weaker signals better. Rotating the dial while holding down this key allows you to set the squelch level.
(14)	PWR (Power) key	Holding down this key turns ON/OFF the power of the receiver.

4-1-3 Key operations

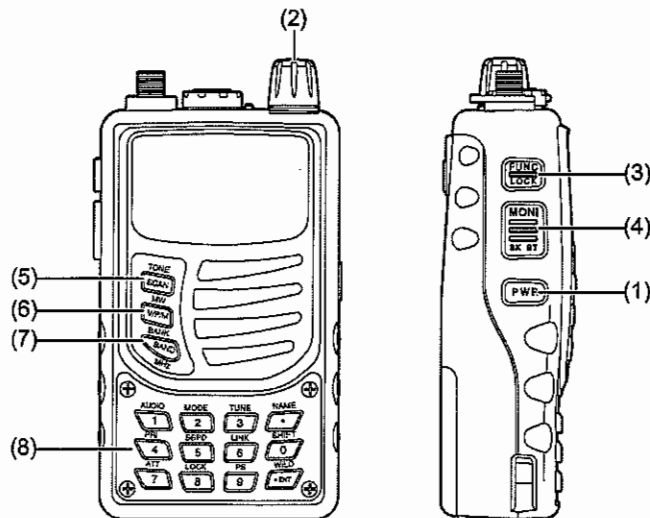

4. Names and Functions of Parts

• Main keys

No.	Item	Description	After the FUNC Key is pressed	Holding Down for 1 Second	Dial Operation While Holding Down
(1)	PWR	Turn the power ON/OFF	_____	Turn the power ON/OFF	_____
(2)	Dial	Set frequency, volume, or other parameters/values	Switch to the Set mode	_____	_____
(3)	FUNC	Switch among Functions	_____	activates/deactivates the quick-Key-lock	_____
(4)	MONI	Perform the Monitor function	Set the tuning step/memory skip	_____	Adjust the squelch level
(5)	SCAN	Start/stop scanning	Switch between the Tone Squelch, Reverse Tone Squelch, and Descrambling (E)	_____	Switch among scan modes
(6)	V/P/M	Switch between the VFO, Preset, and Memory modes	Write data to the memory	_____	_____
(7)	BAND	Switch among bands	Switch banks	Changes frequencies at 10 MHz/1 MHz step	Select bands/banks

• Key pad

No.	Item	Description	After the [FUNC] key is pressed
(8)	1	Enter 1	Set the audio quality of received signals
	2	Enter 2	Set the modulation mode
	3	Enter 3	Adjust the tuning of the shortwave bar-antenna
	4	Enter 4	Start Priority Monitoring.
	5	Enter 5	Set the scan speed
	6	Enter 6	Check the group setting
	7	Enter 7	Set the Attenuator
	8	Enter 8	Set the charge Function
	9	Enter 9	Start the Quick Programmed Scan
	0	Enter 0	Set the frequency shift
	.	Enter a decimal point	Set the memory name
	•ENT	Confirm the entry	Set the wild key (Default: Antenna type)

Reference: For operation details, refer to "Useful Functions/Operations When Key Pad is Installed".

4. Names and Functions of Parts

4-2 LCD Display

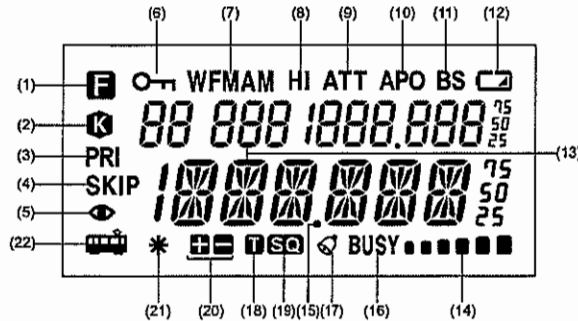

No.	Icon	Description
(1)		Appears when the FUNC key is pressed.
(2)		Appears while the Normal Key Lock is activated.
(3)	PRI	Appears while the Priority Monitoring function is ON.
(4)	SKIP	Appears while the skip is set.
(5)		Appears while monitors the priority channel.
(6)		Appears while the Quick Key Lock is activated.
(7)	WFMAM	Indicates the modulation mode (AM/FM/WFM).
(8)	HI	Appears while the audio quality is set to HI.
(9)	ATT	Appears while the Attenuator is activated.
(10)	APO	Appears while the Auto-Power-Off function is ON.
(11)	BS	Appears while the Battery save function is ON.
(12)		Appears when the remaining battery power is low.
(13)		Displays a receiving frequency or a setting value.
(14)		Indicates the strength of the receiving signals.
(15)		Blinks during scanning.
(16)	BUSY	Appears when a squelch is OPEN.
(17)		Appears while the Bell function is ON.
(18)		Appears/blinks while the Tone Squelch/Reverse Tone Squelch function is ON.
(19)		Appears when a tone signal is detected.
(20)		Indicates the shift direction.
(21)	*	Appears while Descrambling function is ON. (E)
(22)		(Not used with the DJ-X30)

5. Basic Operation

5-1 Turning the Power ON

- 1 Hold down the [PWR] key to turn the power ON.
Hold down the key again to turn the power OFF.

5-2 Adjusting Volume Level

5

Volume can be adjusted within the range of 31 levels (0 to 30).
The default is set to 20.

- 1 Press the dial once.
The current volume level is displayed.

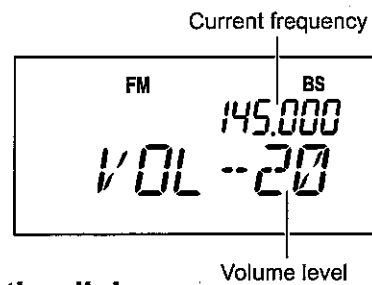

- 2 Adjust the volume level by rotating the dial.

Turn the dial clockwise to increase the volume, and counterclockwise to decrease it. You may open the squelch by holding [MONI] key to hear a noise to set the level properly (P. 28).



CAUTION

- When using an earphone, be careful that the volume is not set too loud. Start from a small volume and gradually increase the level as you listen.



MEMO

- When nothing is heard
- When the squelch is closed or the Mute function is activated, you will hear nothing even if you increase the volume level.
For details, refer to the following sections "Adjusting Squelch Level" (P. 28) and "Mute function" (P. 29).

5-3 Adjusting Squelch Level

• What is "squelch"?

The Squelch function activates the speaker only when signals at a specified level or higher are received. This makes it easier to catch target signals by eliminating the noise which occurs when no signals are received.

When the squelch level is increased, the receiver can receive strong signals, but cannot receive weak signals.

"To open the squelch" means to deactivate the squelch. "To close the squelch" means the opposite. The strength of the signals required to open the squelch is determined by the squelch setting level. This level is adjustable because it varies in some degree depending on the location of signal reception and receiving frequency.

5

The squelch can be adjusted within the range of 10 levels (0 to 9).
The default is set to 3.

5-3-1 Operating procedure

- 1 Hold down the [MONI] key and rotate the dial.

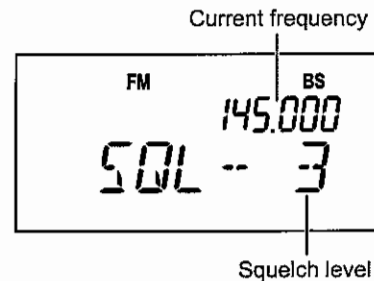

The squelch level increases when the dial is rotated clockwise, and decreases when the dial is rotated counterclockwise.

- To keep the squelch constantly open, set the squelch level to 0.
- Scanning is disabled while the squelch is open. To enable scanning, adjust the squelch level until you cannot hear any noise.

5-3-2 Monitor function

The Monitor function forces the squelch to open. When receiving signals are relatively weak or are often interrupted, it opens the squelch temporarily, regardless of the current squelch level. This function is activated when the "Monitor/Mute function setting" (P. 66) is set to the Monitor function.

There are two options for the Monitor function: PUSH and HOLD. When the [MONI] key is pressed, both options open the squelch and the "BUSY" appears on the LCD.



5

- When PUSH is selected, the squelch opens only while the [MONI] key is held down. When the [MONI] key is released, the squelch returns to the original level.
- When HOLD is selected, the squelch remains open once the [MONI] key is pressed. When the [MONI] key is pressed again, the squelch returns to the original level.
- For the procedure to switch between PUSH and HOLD, refer to "Monitor key operation setting" (P. 65).



MEMO

- When the Monitor function is used, the Tone Squelch functions are also disabled temporarily.

5-3-3 Mute function

The Mute function cuts off the audio output even when signals are received and the squelch is open. This function is activated when the "Monitor/Mute function setting" (P. 66) is set to the Mute function.

There are also two options for the Mute function: PUSH and HOLD. When the [MONI] key is pressed, both options put the receiver on mute and the "BUSY" blinks on the LCD.

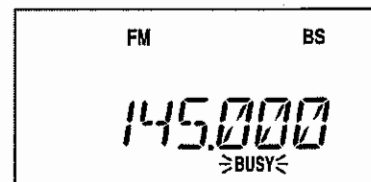

MEMO

- The Monitor function and Mute function cannot be selected simultaneously.

5-4 Operating Modes

The DJ-X30 has three operating modes: VFO, Preset, and Memory.

VFO mode	VFO stands for Variable Frequency Oscillator. You can select a desired frequency by rotating the dial.
Preset mode	The audio frequencies for AM/FM radio and TV channels have already been set so that you can choose among them just like a conventional radio.
Memory mode	You can program frequencies to memory channels beforehand and call up one when you wish. For the frequency programming procedure, refer to "Memory Mode" (P. 35).

5

- Switching between operating modes

Pressing the  key changes operating modes in the following order.

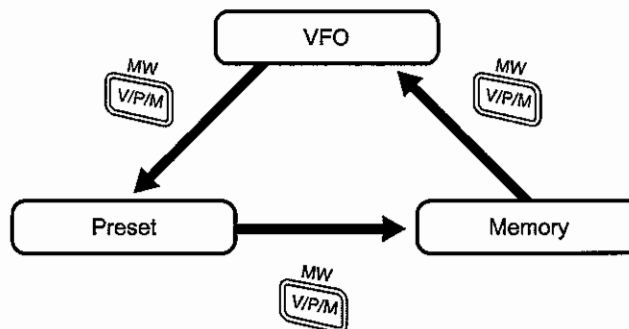



When no data is programmed to memory channels, the Memory mode is skipped.

5-5 Frequency Settings

5-5-1 Setting frequencies in VFO mode

The VFO mode is a mode displayed when you turn ON the DJ-X30 for the first time with the factory default setting. In this mode, you can select receiving frequencies by rotating the dial.

• **Switching between bands**

- Every time you press the  key, the bands shown in the table below are switched in the listed order.
- You can also select bands by rotating the dial while holding down the  key.

5-5-2 Specifying tuning step frequencies

Tuning steps refer to the intervals between the frequencies which have been assigned to radio communications and broadcasts.

The default of the tuning steps can be changed (see P. 32).

The default is set to "Auto". It is not necessary to change the default for normal operation, however, this feature may be useful when you wish to receive frequencies which are hard to tune with the "Auto" setting.

5

• **Switching among bands (T, K version)**

For T version, every time you press the  key, the following 8 bands can be switched in listed order.

	.100	(100 to 529 kHz)	*1	AM
	.530	(530 to 28.995 MHz)		AM
	29.000	(29.000 to 59.745 MHz)		FM
	59.750	(59.750 to 107.995 MHz)		WFM
Default	145.000	(108.000 to 215.995 MHz)		FM
	216.000	(216.000 to 399.995 MHz)		FM
	400.000	(400.000 to 959.995 MHz)		FM
	960.000	(960.000 to 1299.995 MHz)		WFM

• **Switching among bands (E version)**

For E version, every time you press the  key, the following 14 bands can be switched in listed order.

	.100	(100 to 521 kHz)	*1	AM
	.522	(522 to 1620 kHz)	*2	AM
	1.625	(1.625 to 49.995 MHz)		AM
	51.000	(50.000 to 75.995 MHz)		FM
	87.600	(76.000 to 107.995 MHz)		WFM
	118.000	(108.000 to 141.995 MHz)		AM
Default	145.000	(142.000 to 169.995 MHz)		FM
	180.750	(170.000 to 229.995 MHz)		WFM
	270.000	(222.000 to 335.995 MHz)		AM
	380.000	(336.000 to 429.995 MHz)		FM
	433.000	(430.000 to 469.995 MHz)		FM
	476.750	(470.000 to 869.995 MHz)		WFM
	870.000	(870.000 to 959.995 MHz)		FM
	1295.000	(960.000 to 1299.995 MHz)		FM

• **Selectable tuning steps**

Auto, 5 kHz, 6.25 kHz, 8.33 kHz, 10 kHz, 12.5 kHz, 15 kHz, 20 kHz, 25 kHz, 30 kHz, 50 kHz, 100 kHz, 125 kHz, 150 kHz, 200 kHz, 500 kHz, 1 MHz

*1 : Only 1 kHz tuning step is available. This cannot be changed.

*2 : Only 9 kHz tuning step is available. This cannot be changed.

- 1** Press the  key to select a band to change its tuning step.
- 2** Press the [FUNC] key to display the **F** on the LCD.
- 3** Press the [MONI] key. "AUTO" appears on the LCD.
- 4** Press the [MONI] key again. The selection changes from "AUTO" to another tuning step.
- 5** Rotate the dial to select a tuning step. The selection returns to "AUTO" when the [MONI] key is pressed again.

6 Press the [FUNC] key to finish the setting. The LCD returns to the frequency display.

When a tuning step other than "AUTO" is selected for any one band, "AUTO" is cancelled for all bands. The last selected tuning step is stored for each band.

When "AUTO" is selected again for any one band, "AUTO" is selected for all bands. Then, the tuning step specified for the DJ-X30 is automatically selected.

5-5-3 10 MHz/1 MHz UP/DOWN operation

5

1 When the  key is held down while in VFO mode, the digit in the 10 MHz place in the frequency display starts blinking. You can increase or decrease the value of the digit by rotating the dial.

2 When the  key is pressed again, the digit in the 1 MHz place starts blinking. You can increase or decrease the value of the digit by rotating the dial.

3 When the [FUNC] key or the  key is pressed, the frequency display returns to normal.

Display during 10 MHz UP/
DOWN adjustment

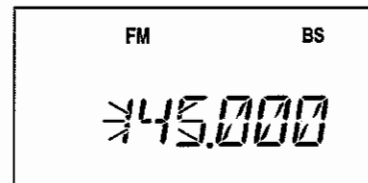

Display during 1 MHz UP/
DOWN adjustment

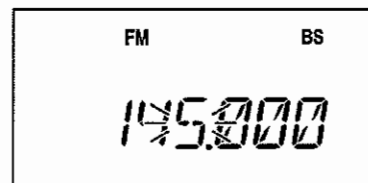



MEMO

• The 10 MHz/1 MHz UP/DOWN operation increases or decreases frequencies regardless of the frequency range of each band.

5-5-4 Setting frequencies in Preset mode

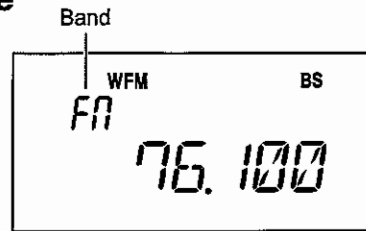
- 1 While in VFO mode, press the  key once. The DJ-X30 is set to the Preset mode and the band is displayed on the LCD.



- 2 Press the  key to select a desired band. Every time the  key is pressed, the band is changed in the order shown on the right.

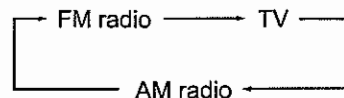

- 3 Rotate the dial to select a frequency (or a TV channel).

5

5-5-5 Setting frequencies in Memory mode

When no data is programmed to memory channels, the Memory mode is skipped. Please refer to Memory Mode on P. 36 and store data first.

- 1 While in VFO mode, press the  key twice. The DJ-X30 is set to Memory mode and a bank and a memory channel are displayed on the LCD.

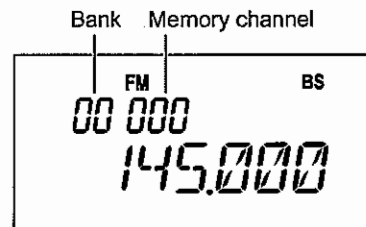

- 2 Press the  key to select a desired bank.

- 3 Rotate the dial to select a channel.

You cannot select banks or channels which have not been programmed.



- You can select banks also by rotating the dial while holding down the  key.

5-6 Memory Mode

Memory mode allows you to pre-program frequently-used frequencies into the DJ-X30's memory so that you can call up a desired frequency when you wish. A "bank" is a location where frequencies are categorized for easier selection. Each frequency programmed to a bank is called a "channel."

5-6-1 Memory types and usage

The DJ-X30 has the following four types of memory bank.

Bank for normal memory channels	Contains channels which are called up in normal operation in Memory mode. A total of 1000 channels of frequencies can be programmed. You can program your favorite frequencies to call them up easily.
Bank for programmed scan channels	Contains channels which are used for the programmed scan to find signals within a specified frequency range. Up to 50 pairs of frequency ranges (upper and lower limits) can be programmed.
Bank for skip-search channels *Some channels have been pre-programmed in the factory.	Frequencies programmed to this bank are skipped during VFO and programmed scans. Up to 100 channels* can be programmed. It is useful to program unwanted frequencies that emit constant noise.
Bank for priority channels	This bank is used for the Priority Monitoring function (prioritized reception). Up to 100 channels can be programmed.



CAUTION

- You cannot program duplicated frequencies to the bank for skip-search channels. If you try to do so, an error beep will sound.

5-6-2 Programming a memory channel

- 1** In VFO mode, tune to the frequency you wish to program.
- 2** Press the [FUNC] key to display the **F** on the upper left of the LCD.
- 3** Press the  key to select a bank.

Each bank corresponds to the following memory channels.

0 to 9	Banks for normal memory channels
PS	Bank for programmed scan channels
PA	Bank for skip-search channels
Pr	Bank for priority channels

Select an appropriate bank according to the usage.

- 4** Rotate the dial to select a channel.

The number of programmable channels differs depending on the bank type as follows:

0 to 9	000 to 099 (The number of programmable channels varies depending on how you separate each bank by using an optional utility software.)
PS	0A to 49b
PA	000 to 099
Pr	000 to 099

A blinking channel number indicates that no data is programmed to the channel.

A channel number which does not blink and is displayed constantly indicates that data has been programmed to the channel.



5 Press the  key to save the memory data.



MEMO

- By default, it is not possible to overwrite the channel to which data has been programmed.
- To delete or edit memory data, disable the Write-protect (memory protection) function (P. 68) and then continue the procedure.

Example: When programming a frequency of 145.000 MHz to channel 002 of bank 01

- (1) In VFO mode, tune to frequency 145.000.
- (2) Press the [FUNC] key.
- (3) Press the  key and select bank "01".
- (4) Rotate the dial to select memory channel "002".
- (5) Press the  key to complete the programming.

5

- Example display of a frequency programmed to a memory channel (Press  key twice to see this after above procedure (1) ~ (5) has been completed.)

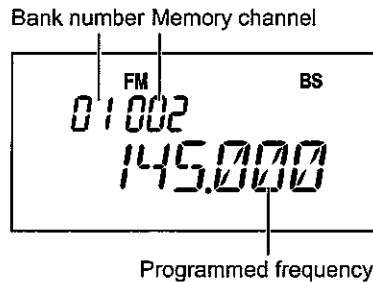

CAUTION

- The bank for programmed scan channels requires programming of two frequencies to channels *A and *b.

Example: When a frequency of 145.020 MHz is programmed to channel 0A, and a frequency of 146.100 MHz is programmed to channel 0b.



The programmed scan operation scans the range between 145.020 MHz and 146.100 MHz which is programmed to channel 0b.



MEMO

- It is not possible to increase the number of memory channels.
- You can set alphanumeric characters or symbols, instead of frequencies to represent the programmed memory channels. For details, refer to "Memory Naming Function" (P. 50).
- Memory channels can be called up by using either the dial or key pad.

5-6-3 Deleting a memory channel

- 1** Disable the Write-protect (memory protection) function by referring to P. 68.
- 2** Press the  key to switch to the Memory mode.
- 3** Select the channel you wish to delete.
- 4** Press the [FUNC] key to display the **F** on the LCD.
- 5** Press the  key while the **F** is displayed, to delete the frequency programmed to the memory channel.

5



- Once data is deleted, it cannot be restored. Check carefully that you are deleting the right data in advance to perform this operation.
- To prevent important data from being deleted accidentally, be sure to reactivate the Write-protect (memory protection) function (P. 68) after deleting data. If you forget to do this, all data in the memory will be deleted when the "Reset Function" (P. 79) is used.

• Items which can be programmed to memory channels

The following items can be stored in the memory channels.

- Frequency
- Shift frequency*
- Shift direction*
- Tone frequency*
- Modulation mode*
- Tone squelch/Reverse Tone squelch setting/Descrambling decode number. (E)*
- Memory name
- Skip setting*

(* : Please refer to P. 39 for details)



By using the free software provided by the Alinco website (<http://www.alinco.com/>) and the optionally available PC programming cable (ERW-4C/ERW-7), you can separate each bank of the normal memory channels as desired (up to 50 banks x desired number of channels less than 1000 channels).

This function enhancement is possible only via the editing software, and cannot be operated with the keypad of the receiver.

6. Useful Functions

6-1 Scanning Function

The Scan function automatically searches for signals currently being received by DJ-X30.

The following scan types are available.

VFO scan	In VFO mode, the scan searches all frequencies within the selected band by using the tuning step specified in advance.
Preset scan	The scan searches the frequencies within the band specified in Preset mode.
Memory scan	In memory mode, the scan searches for only frequencies which have been programmed in the memory in advance.
Programmed scan	The scan searches a range of frequencies between upper and lower limits which can be set by the user in advance.



6







MEMO

- The programmable items shown in P.38 with * do not affect their functions while programmed scanning, but setting such as tone-squelch and modulation mode must be completed in VFO mode, and VFO parameters are always respected for programmed scan.

• Operations common to all scan types

- Scanning stops when any one of the [FUNC], , , or  keys is pressed.
- The scanning direction can be changed by rotating the dial during scanning.
- When the Monitor function is used, scanning is suspended to open the squelch temporarily. Releasing the Monitor function resumes scanning.
- Scanning starts in the direction of the last scan. (Programmed scan, however, starts scanning from **A to **b.)
- You can specify conditions to resume scanning. For the setting procedure, refer to "Scan Type Switching setting" (P. 61).



6-1-1 VFO scan

- 1 Press the  key to switch to VFO mode, if necessary.
- 2 Press the  key to select the band to scan.
- 3 While holding down the  key, rotate the dial to select "VFO" .
- 4 Release the  key to start scanning.



During scanning, the decimal point of the displayed frequency blinks.

6-1-2 Preset scan

- 1 Press the  key to switch to the Preset mode.
- 2 Press the  key to select AM radio, FM radio, or TV.
- 3 Press the  key to start scanning.

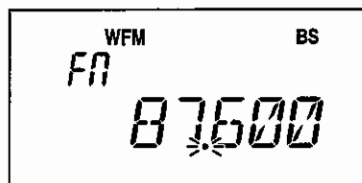

During scanning, the decimal point of the displayed frequency blinks.

6

6-1-3 Memory scan

In Memory mode, either a specified bank or all banks are scanned. The memory scan offers the following three types of scanning methods.

Single-bank scan	This scans only through a specified bank.
Group scan	This scans only a group of previously selected banks.
All-bank scan	This scans all available banks which are previously programmed.



- Bank grouping is possible only when the key pad is installed (see P. 54).
- Banks other than normal memory channels such as PS, PA and Pr cannot be scanned.
- By using the free downloadable software available at the Alinco website, the all-bank scan can be expanded to scan up to 50 banks (0 to 49).

6

1 Press the key to switch to Memory mode.

2 Hold down the key and rotate the dial to select the scanning method.

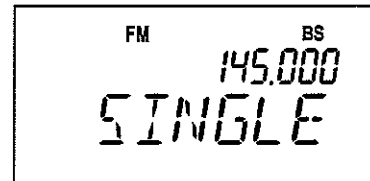

Each method is displayed as follows on the LCD.

- SINGLESingle-bank scan
- GROUPGroup scan
- ALLAll-bank scan

When you select single-bank scan, the bank which is currently displayed in Memory mode will be scanned.





- Please program the banks in advance to use all features of the memory scan. The scanning method display may not appear when the programming is incomplete.

3 Release the key to start scanning.

During scanning, the decimal point of the displayed frequency blinks.

6-1-4 Programmed scan

The Programmed scan searches a range of frequencies specified by upper and lower limits. The specified upper and lower frequencies are collectively referred to as a "programmed scan channel". The DJ-X30 can store up to 50 pairs of programmed scan channels. For more information, refer to "Programming a memory channel" (P. 36). Note that you need to program data in the bank for programmed scan channels in advance. If you do not do this, the following operation cannot be performed.

- 1** Press the  key to switch to VFO mode, if necessary.
- 2** While holding down the  key, rotate the dial until "PRGRM" appears on the LCD, then, select a pair of programmed scan channels to use for the scan by observing the channel indication. You may disregard A or b, just tune to either one of the pairing channel.
- 3** Release the  key to start scanning. During scanning, the decimal point of the displayed frequency blinks.

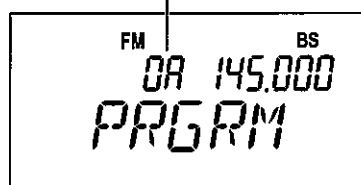

Programmed scan channel



6

6-2 Memory Skip Function

The Memory Skip function enables you to skip a specified memory channel during the Memory scan operation. Since scanning always stops at active channels, such as broadcasts, skipping such channels ensures efficient scanning.

- 1** Press the  key to switch to Memory mode.
- 2** Select the memory channel you wish to skip.
- 3** Press the [FUNC] key to display the  on the LCD.
- 4** Press the [MONI] key.

"SKIP" appears on the left of the LCD, indicating that the Memory Skip function is set to the channel.

To deactivate the Memory Skip function, select the memory channel and follow steps **3** and **4** above.

The "SKIP" on the LCD disappears and the function is deactivated.

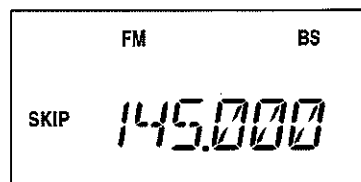

6-3 Key-lock Function

The Key Lock function avoids unwished, incorrect, or unauthorized operation of the keys and dial.

Two types of locking are available: Quick Lock which can be activated easily, and Normal Lock which is more complicated to unlock.

6-3-1 Key-lock procedure

- **Quick Lock**

Hold down the [FUNC] key for about a second to switch the function ON/OFF.

While the Normal Lock is active, the  appears on the LCD.

- **Normal Lock**

Press the dial three times while holding down the  key to switch the function ON/OFF.

While the Normal Lock is active, the  appears on the LCD.

6



CAUTION

• To release the Key-lock function, you must use the same method you used to activate the lock. The "reset" operation (P. 79) unlocks both.

6-3-2 Available operations while the Key-lock is active

Other than power ON/OFF, only below operations are permitted while the Key-lock is activated.

Volume adjustment: You can adjust the volume level by rotating the dial.

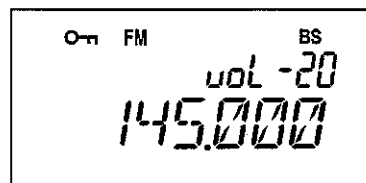

Squelch adjustment: You can adjust the squelch level by rotating the dial while holding down the [MONI] key.

6-4 Tone Squelch/Reverse Tone Squelch Function

The Tone Squelch/Reverse Tone Squelch system sends almost inaudible low-frequency signals (CTCSS tones) by radio waves and has the receiver detect the presence or frequency of the signals, so that only audio of a specified communication can be heard from the receiver speaker.

The Tone Squelch function opens the squelch when the received tone frequency matches with the frequency specified by the DJ-X30.

If you specify the tone frequency of the communication you wish to listen to in advance, the squelch opens only when that tone frequency is received.

The Reverse Tone Squelch function closes the squelch when the received tone frequency matches with the frequency specified by the DJ-X30.

6

- 1** Rotate the dial to tune to the channel on which the CTCSS (Tone Squelch/Reverse Tone Squelch) system is used.
- 2** Press the [FUNC] key to display the **F** on the LCD.
- 3** Press the  key several times. For Tone Squelch select the **T**. For Reverse Tone Squelch, select the blinking **T**.
- 4** Rotate the dial to select the CTCSS tone frequency and press the [FUNC] key.



For more information, refer to "Table of Available CTCSS Tones" (P. 83).

When the Tone Squelch function is ON and the squelch opens when a signal of the specified tone is received, the **SQ** appears on the LCD. When the Reverse Tone Squelch function is ON, the **SQ** appears on the LCD and the squelch closes when a signal of the specified tone is received.
- 5** To deactivate the Tone Squelch/Reverse Tone Squelch function, press the [FUNC] key and then press the  key several times until "OFF" appears on the LCD. Then, press the [FUNC] key.



CAUTION

- You should always set the normal squelch level properly even when the Tone Squelch function is used. If the normal squelch remains open, the Tone Squelch operation will require slightly a longer time.

6-5 Descrambling Function (E-Version only)

The Descrambling function returns scrambled voice to normal reception. This feature is available only for the E version.

1 Tune to a signal using analog-inversion scrambling.

2 Press the [FUNC] key to display the **F** on the LCD.

3 Press the  key several times until "SCR" appears on the LCD.



4 Adjust the audio quality by rotating the dial.

Select a number from 0 to 28 where you can hear clear audio output. Press the [FUNC] key to activate this function and return to receiving mode adjust the audio.

5 To deactivate the Descrambling function, press the [FUNC] key and then press the  key until "OFF" appears on the display. Then, press the [FUNC] key.



- Use of the Descrambling function may be prohibited in some jurisdictions. Check local regulations before use.

6-6 Tone Scan Function

The Tone Scan function automatically detects a CTCSS tone frequency in the received signals.





1 In VFO mode, tune to the channel you wish to scan for the tone frequency.

2 While holding down the  key, rotate the dial until "TONE" appears on the LCD.



3 Release the  key.

Scanning starts. Tone frequencies being scanned for are displayed one by one on the LCD. When a matching tone is detected, the receiver beeps, the  and the tone frequency appear on the LCD, and scanning stops.

4 Scanning continues endlessly if a matching tone frequency is not found in the received signals. To quit scanning, press any one of the , , , or  keys. The receiver returns to VFO mode.



• Not all communication uses the CTCSS tone. You can receive all communications that use CTCSS tone by deactivating the tone squelch function. This function is intended for "selective reception", intentionally avoiding the reception of unwanted signals.

7. Useful Functions/Operations When Key Pad is Installed

Installing the key pad in the DJ-X30 enables the following:

1. Direct input of desired frequencies from the key pad.
2. Volume adjustment from the key pad
3. Selection of memory channels and Set mode items
4. Function enhancement by pressing the key pad keys after press the [FUNC] key.

7-1 Basic Key Pad Operation

The key pad is arranged as shown below.

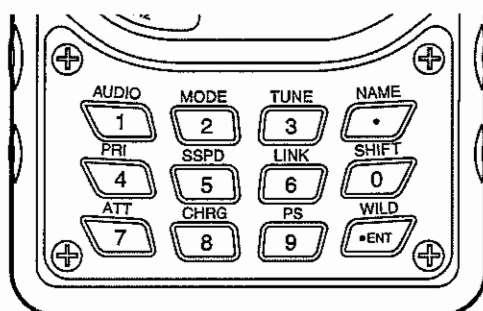

To directly input a desired frequency

Example 1 : To input 450.250 MHz

Press the ^{PRI}4, ^{SSPD}5, ^{SHIFT}0, ^{NAME}., ^{MODE}2, and ^{SSPD}5 keys in this order and then press the ^{WILD}ENT key.

Example 2 : To input 0.810 MHz (810 kHz)

Press the ^{NAME}., ^{CHRQ}8, and ^{AUDIO}1 keys in this order and then press the ^{WILD}ENT key.

If you input a wrong frequency, rotate the dial to redo the input from the beginning.

7-2 Audio Quality Switching Function

The Audio Quality Switching function switches the audio quality (tone) of the received signals. Use this function as necessary. Audibility may also vary depending on the modulation mode.

1 Press the [FUNC] key to display the **F** on the LCD.

2 Press the  key.

"AFtonE" appears on the LCD.

3 Rotate the dial to switch the audio quality.

The audio quality is switched between "LOW" and "HIGH".



4 Press the [FUNC] key to complete the selection.

7

7-3 Modulation Mode Switching Function

You can manually select the modulation type you wish to use to receive signals.

1 Press the [FUNC] key to display the **F** on the LCD.

2 Press the  key.

"WAV-AT" appears on the LCD.

3 Select the modulation type by rotating the dial or pressing the  key.

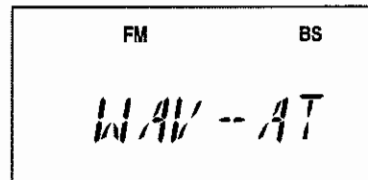

Description of modulation modes

AT	The main modulation mode assigned to the frequency is selected automatically.
AM	Amplitude modulation: Mainly used for AM radio broadcasting, shortwave broadcasting, and aviation radio.
FM	Frequency modulation: Popular in amateur radio and commercial communications.
WFM	Frequency modulation: An FM system used for such applications as FM radio broadcasting or relay broadcasting where high audio quality is required. This type is called Wide FM to differentiate it from the FM mode for communication.

4 Press the [FUNC] key to complete the setting.

7-4 Shortwave Tuning Function

The Shortwave Tuning function is used to manually adjust the sensitivity of the reception when the shortwave bar-antenna is used.

Use this function when you have difficulty hearing a shortwave broadcast. The default is set to "AUTO". In most cases, it is unnecessary to change the setting. Use this function when shortwave broadcast signals are difficult to receive with the AUTO setting.

1 Press the [FUNC] key to display the **F** on the LCD.

2 Press the  key.
"tUntyP" appears on the LCD.

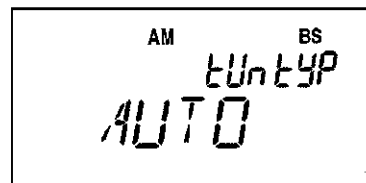

3 Press the  key again.
"TLEVEL" appears on the LCD with a number above it.

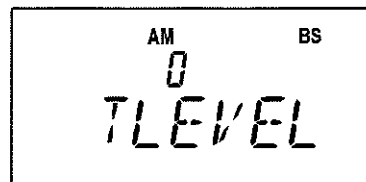

- 4 Rotate the dial to adjust the sensitivity so that you can hear audio signals clearly.**
- 5 Press the [FUNC] key to complete the setting.**





• The distance travelled by radio waves in the shortwave band (propagation) varies depending on the time of day, season, and frequency. Receiving signals in this frequency band inherently requires a large antenna. Consequently, you can receive only strong signals with the small antenna included with the DJ-X30.

7-5 Memory Naming Function

You can name the memory channel programmed in the Memory mode by using up to 6 alphanumeric characters and symbols in total.

7



- Registering a memory name

- 1 Press the  key to switch to Memory mode.**
- 2 Tune to the memory channel you wish to name.**
- 3 Press the [FUNC] key to display the  on the LCD.**
- 4 Press the  key.**

The frequency is displayed on the upper right of the LCD, and the cursor starts blinking on the left of the LCD.

- 5 Select characters by operating the keys and dial as follows.**

Key operations for the Memory Naming function

FUNC	Determines the memory name.
Dial	Selects a character.
	Moves the cursor to the right.
	Clears all characters which have been input.
	Moves the cursor to the left.

• The following table lists available characters.

0	0	A	A	N	N	R	a	n	n	'	!	,	.	-	-
1	1	B	B	O	O	b	b	o	o	"	"	/	/	`	`
2	2	C	C	P	P	c	c	P	p	#	#	_	:	{	{
3	3	D	D	Q	Q	d	d	q	q	\$	\$;	:		
4	4	E	E	R	R	e	e	r	r	%	%	'	<	>	}
5	5	F	F	S	S	f	f	s	s	&	&	=	=	^	^
6	6	G	G	T	T	g	g	t	t	'	')	>		Space
7	7	H	H	U	U	h	h	u	u	((?	?		
8	8	I	I	V	V	,	,	v	v))	@	@		
9	9	J	J	W	W	j	j	w	w	*	*	[[
		K	K	X	X	k	k	x	x	+	+	¥	¥		
		L	L	Y	Y	l	l	y	y	,	,]]		
		M	M	Z	Z	m	m	z	z	-	-	'	'		

7

6 Press the [FUNC] key.

The memory name is registered.



Clearing a registered memory name

- Follow the steps **1** through **4** above, press the  key in step **5**, and then press the [FUNC] key. The selected memory name is cleared.

7-6 Priority Monitoring Function

The Priority Monitoring function monitors two channels alternately, so that you can catch signals of one frequency effectively while receiving the signals of the other frequency. After receiving signals of the main channel for 5 seconds (*1), the DJ-X30 monitors the priority channel for 0.5 seconds to see if there are any signals being sent.

This function is useful when you set your favorite channel as a main channel, and set a channel of interest as a priority channel.

- 1 In set mode, select a priority channel. (P. 62)**
- 2 Tune to the main channel, and press the [FUNC] key to display the  on the LCD.**

3 Press the  key.

"PRI" appears on the left of the LCD.

When the DJ-X30 monitors the priority channel, the  is displayed.

When the DJ-X30 receives signals on the priority channel, a beep sounds. The reception continues until the signals sent from the priority channel stop (*2).



4 To cancel the Priority Monitoring function, press any one of the [FUNC], , , or  keys.



*1 The interval at which the priority channel is monitored can be changed in Set mode via the "Priority Monitoring interval setting" (P. 62).

*2 The time for which priority channel signal reception is stopped can be changed in Set mode via the "Priority Monitoring duration setting" (P. 62).

- When no data is programmed to the priority channel, the Priority Monitoring function is disabled.
- Scanning is disabled while the Priority Monitoring function is ON.
- The channel to be used for Priority Monitoring can be selected from the bank for priority channels by using the "Priority channel selection" of the Set mode (P. 62).
- Since the DJ-X30 monitors the priority channel every 5 seconds (*1), the audio of the main channel is momentarily interrupted at this interval. Although this phenomenon is conspicuous in particular for constant signals such as a broadcast, this is not a receiver failure.

7-7 Scan Speed Switching Function

The Scan Speed Switching function changes the scan speed.

Set the scan speed faster to receive strong signals only or to scan quickly, and set the speed slower to receive weak signals.

1 Press the [FUNC] key to display the **F** on the LCD.

2 Press the  key.

A number is displayed. By rotating the dial, you can adjust the speed in five levels.

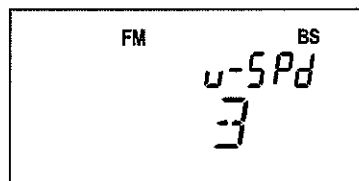

The scan speed is adjusted as follows:

1: Slowest ←→ 5: Fastest

When "v-SPd" is displayed, you can change the scan speed for the following scan modes:

- VFO scan
- Preset scan (AM/FM radio)
- Programmed scan

When the  key is pressed again, "M-SPd" is displayed.

In this state, you can change the scan speed for the following scan modes.

- Memory scan
- Preset scan (TV)

3 Press the [FUNC] key to complete the selection.





• To obtain the best scan performance:

- A: Use skip-search memories to skip unwanted, consistently receiving noise or broadcasts.
- B: Set the scan speed parameter slower to search for weaker signals.
- C: To program the memory channels in a bank, sort them in order of the frequency.

7-8 Group Setting/Checking Function





During the Memory scan, the banks used for the scan can be grouped as desired.

Up to nine groups can be set as default.* Each group corresponds to keys  through .

The following procedures are possible only when there are already programmed memory channels in the banks.

* Up to 50 by using the editor software.

7-8-1 Setting a group

- 1** Press the  key to switch to Memory mode.
- 2** Press the  key to select a bank to include in a group.
- 3** Hold down the key of a desired group number ( through  as a factory default) until "GRP-on" appears on the LCD and the receiver beeps.

FM BS

145.000

GRP-on
- 4** To add other banks to the group, repeat the above steps **2** and **3**.

Example of group setting

To include banks 01 and 03 in group 5

(1) In Memory mode, select bank 01.

(2) Hold down the  key.

Check that a beep sounds and that "GRP-on" appears on the LCD.



If "GRP-of" appears, the bank is excluded from the group. In such a case, hold down the  key again to add the bank to the group.

(3) Select bank 03.

As in step (2), hold down the  key and check that "GRP-on" appears.

7-8-2 Checking banks in a group

You can view all banks registered in a group.

- 1** Press the [FUNC] key to display the **F** on the LCD.
- 2** Press the  key.
"GroUP1" appears on the LCD. The last character "1" indicates the group number.
- 3** Press the key of the group number ( through  as factory default) that you wish to view the banks of.
- 4** By rotating the dial, you can see the banks registered in the group one by one.
- 5** Press the [FUNC] key to finish checking.





7

7-9 Frequency Shift Function

The Frequency Shift function switches from the frequency currently being received to another frequency with the press of a single key. For example, communication with a repeater (relay) uses sending (uplink) and receiving (downlink) frequencies separately. The Frequency Shift function allows you to receive signals of both frequencies alternately by switching between them with a press of a key.

7-9-1 Setting the Frequency Shift function

- 1** Press the [FUNC] key to the display **F** on the LCD.
- 2** Press the  key to select the direction of the frequency shift.
Every time you press the  key, the display changes in the order shown on the right.

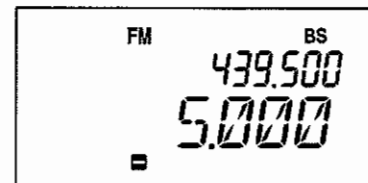

3 Rotate the dial to set the frequency tuned by the shift.

You can change the frequency in steps of 1MHz by rotating the dial while holding down the  key.

4 Press the [FUNC] key to complete the setting.



MEMO

- Normally, communication via a repeater can be received by tuning to the downlink frequency (the frequency which the repeater uses to resend the received signal).
- When this function is used, the base-station signals are relatively strong and can be received easily. The mobile-station signals, however, are not so strong and can be heard only within the coverage area. This function is commonly described as a "reverse-monitor" in amateur radio equipment.

7



7-9-2 Operation procedure

1 The DJ-X30 receives the shift frequency while the  key is pressed.



CAUTION

- Scanning is disabled while the  key is pressed.

To cancel the Frequency Shift function, press the [FUNC] key to display the  on the LCD. Hold down the  key until "NO SFT" appears, and then press the [FUNC] key again.

7-10 Attenuator (ATT) Function Setting

You can quickly jump to the Attenuation function setting menu of the Set mode by performing the following operation:

1 Press the [FUNC] key to display  on the LCD.

2 Press the  key to jump to the Set menu No. 1, "Att".

The setting details are the same as when you select the Attenuator function setting in the Set mode.

For details, refer to "8-2-1 Attenuator (ATT) function setting" (P. 59).

7-11 Charging Function Setting

You can quickly jump to the Charging function setting menu of the Set mode by performing the following operation:

- 1 Press the [FUNC] key to display **F** on the LCD.**
- 2 Press the  key to jump to the Set menu No. 17, "CHArGE".**

The setting details are the same as when you select the Charging function setting in the Set mode.

For details, refer to "8-2-17 Charging function setting" (P. 66).

7-12 Quick Programmed Scan

By setting your favorite programmed scan channel (Refer to "6-1-4 Programmed scan") as a quick programmed scan channel, you can activate the programmed scan to find the channel quickly from any of the VFO, Preset, and Memory modes.

- 1 You need to program the programmed scan channel(s) beforehand in Memory mode. (P. 36)**

For the procedure for setting the channel for the quick programmed scan, refer to "Quick programmed scan channel selection" (P. 72).

- 2 Press the [FUNC] key to display **F** on the LCD.**
- 3 Press the  key to start the programmed scan.**

During scanning, the decimal point of the displayed frequency blinks.



- Only one channel can be specified for the quick programmed scan.
- This operation is disabled when no programmed scan channel has been programmed.

8. Set Mode Configurations

The Set mode allows you to change the DJ-X30's functions and default settings as desired.

8-1 Configuring Values/Parameters of Set Mode Menu Items

- 1** Press the [FUNC] key to display the **F** on the LCD.
- 2** Press the dial once to switch to Set mode.
- 3** Every time you press the dial, the setting item (Set menu item) is changed.
 - When you press the [MONI] key, the items are displayed in reverse order.
 - You can also select items by entering the menu number with the key pad. For the list of the menu numbers, see page **P. 70**.
- 4** Rotate the dial to change the value or parameter of the item.
- 5** To exit the Set mode, press the [FUNC] key.

The changed value/parameter is saved.

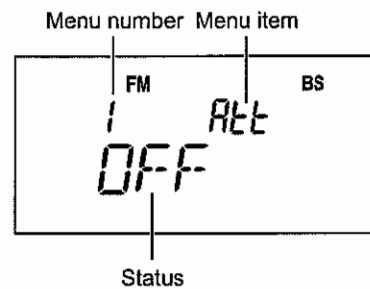

8-2 Set Mode Configurations

Details of each item of the Set mode menu are as follows.

8-2-1 Attenuator (ATT) function setting

Use this function when the receiving signal is interfered with by strong signals from nearby channels. When activated, this function weakens the reception level of the target signal. However, it also makes unnecessary signals difficult to receive, so that the target signal may become distinctly audible. The attenuation level is about 20 dB.

- 1** Select Set menu No. 1, "Att".
- 2** Rotate the dial to display "ON".
"ATT" appears at the top of the LCD.

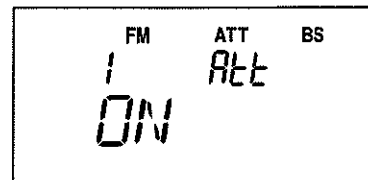

- This function is effective only when an antenna (i.e. the included antenna or an external antenna) is connected to the SMA antenna connector. Set this function to OFF when such an antenna is not connected.

8-2-2 Earphone Antenna setting

Use this function to switch between an earphone antenna and an external antenna. When you select an earphone antenna, the earphone cord works as an antenna. Signals can be received even when an external antenna is not connected. An optional earphone is necessary.

- 1** Select Set menu No. 2, "Ant EnA".
- 2** Rotate the dial to change the display from "SMA" to "EAR".
You can now use an earphone as an antenna.

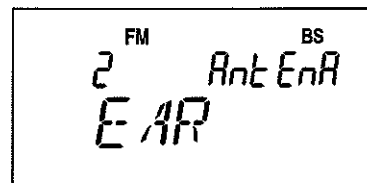

- When an earphone antenna is used, the received signals may be unstable depending on the condition of the earphone cord.
- Like the earphone antenna on a card-type transistor radio, the earphone antenna is not tuned for specific frequencies. As a result, it may only be able to properly receive strong signals such as those of FM broadcasts or from near sources.

8-2-3 AM Radio Bar-antenna setting

You can choose either the built-in bar-antenna or an external antenna to receive AM radio signals. The bar-antenna covers the range of 100 kHz to 3 MHz including the AM radio band.

- 1** Select Set menu No. 3, "AbAr".
- 2** To use an external antenna, rotate the dial to change the display from "ON" to "OFF".

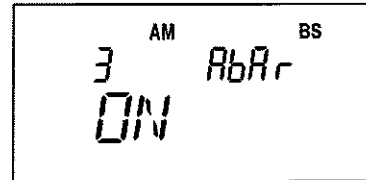

The default is set to use the built-in bar-antenna. If you are using an external antenna, connect it to the SMA antenna connector.

8-2-4 Shortwave Bar-antenna setting

You can choose either the built-in bar-antenna or an external antenna to receive shortwave signals. The bar-antenna covers the range of 3 MHz to 30 MHz including the shortwave band.

- 1** Select Set menu No. 4, "SbAr".
- 2** To use an external antenna, rotate the dial to change the display from "ON" to "OFF".

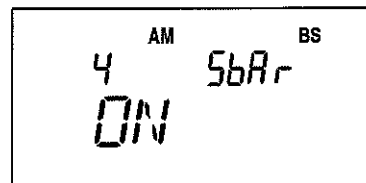

If the sensitivity is insufficient, refer to "Shortwave Tuning Function" (P. 49).

8-2-5 Lamp Operation setting

You can set the operation of the backlight of the LCD. Using the backlight frequently increases the drain on the battery.

- 1 Select Set menu No. 5, "LAMP".

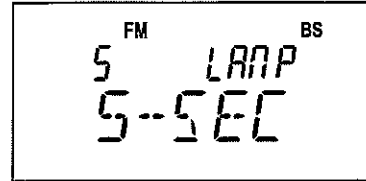

- 2 Rotate the dial and the backlight operation changes as shown in the figure.

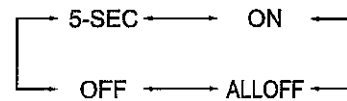

OFF	The backlight does not turn ON.
5-SEC	When you operate the keys, the backlight turns ON for 5 seconds.
ON	The backlight continues illuminating.
ALLOFF	The backlight and RX lamp do not turn ON.

8-2-6 Scan Type Switching setting

You can customize the scan-resume condition.

- 1 Select Set menu No. 6, "SCAN".

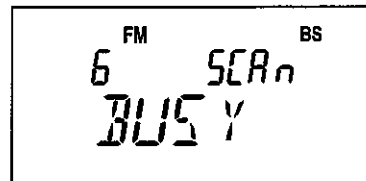

- 2 When you rotate the dial, the display changes from "BUSY" to a value between 1 and 25 seconds ("1-SEC" through "25-SEC").

"BUSY" indicates busy scan mode, and "1-SEC" through "25-SEC" indicates the timer scan mode. Refer to the table below and select a desired setting.

Busy scan mode	After scanning stops, the DJ-X30 resumes scanning when the receiving signal is gone.
Timer scan mode	After scanning stops, the DJ-X30 resumes scanning after the specified time even though it is still receiving signals. This time can be set to any value from 1 to 25 seconds. (Indicated on the LCD as "1-SEC" through "25-SEC")

8-2-7 Priority Channel selection

Use this function to select a priority channel. This setting is effective when priority channels have been programmed in Memory mode (P. 35).

- 1** Select Set menu No. 7, "Prio".
- 2** Rotate the dial to select a priority channel.

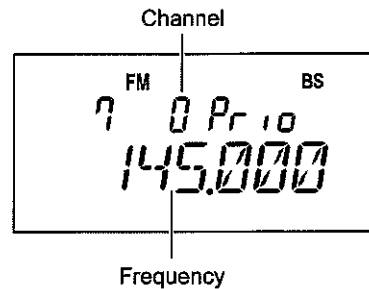

8-2-8 Priority Monitoring interval setting

You can select the interval for which signals from the main channel are received when the Priority Monitoring function is ON.

- 1** Select Set menu No. 8, "tiMESP".
- 2** Rotate the dial to select the monitoring interval.

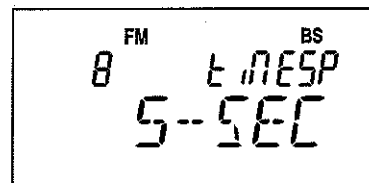

- 3** By rotating the dial, you can set the interval within the range of 5 to 60 seconds.

8-2-9 Priority Monitoring duration setting

You can select the time for which reception of signals from the priority channel is stopped when the Priority Monitoring function is ON.

- 1** Select Set menu No. 9, "tiMEPr".
- 2** Rotate the dial to select the monitoring duration.

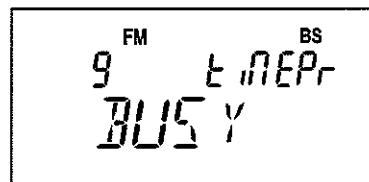

- 3** This setting also provides busy mode and 1- to 25-second timer mode options.

Select the option according to the table in "Scan Type Switching setting" described previous.

8-2-10 Band Transition setting

When the setting frequency reaches the upper or lower end of the current band during scanning or dial operation in the VFO mode, you can select whether to return to the other end of the same band, or to move to the next band.

- 1 Select Set menu No. 10, "bAnd".

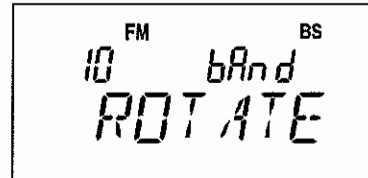

- 2 Rotate the dial to select either "ROTATE" or "ACROSS".

ROTATE	Remain in the same band.
ACROSS	Move to the next band.

8-2-11 APO function setting

APO stands for "Auto Power Off". When no operation is performed for the specified time, a beep sounds and the DJ-X30 is automatically turned OFF.

- 1 Select Set menu No. 11, "APo".

- 2 Rotate the dial to switch OFF the APO function, or to select the setting time. You can select from 30, 60, or 90 minutes, and OFF.

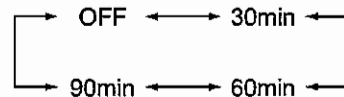

To turn ON the power again after it has been turned OFF by the APO function, hold down the [PWR] key again.



MEMO

- Any key operation can reset the countdown for the APO function and extend the APO time. However, the APO time is not extended only by signal reception.

8-2-12 Battery-save function setting

This function automatically turns ON/OFF the DJ-X30 frequently in order to save power consumption during standby and extend battery operation time.

- 1 Select Set menu No. 12, "bS".

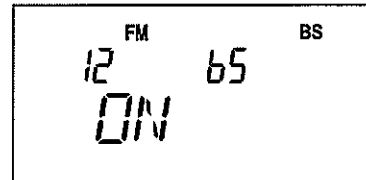

- 2 Rotate the dial to switch between "ON" and "OFF".

When this function is set to ON, "BS" appears on the LCD.

- The default is set to ON. It is not necessary to turn the function OFF in normal operation. The conditions where you need to turn it OFF are when you receive signals of packet communication used for amateur radio, or of data communication for aviation radio (ACARS) and so on.
- This function becomes invalid temporarily while the DJ-X30 is scanning or receiving signals.
- The LCD illuminates even when the DJ-X30 is in standby mode. (The display is the same regardless of whether or not the function is activated.)

8

8-2-13 Beep deactivation setting

You can turn off the beep that you hear every time you push a key.

- 1 Select Set menu No. 13, "bBEEP".

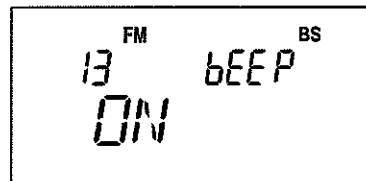

- 2 Rotate the dial to switch between "ON" and "OFF".

When OFF is selected, the beep does not sound.



- Setting the beep to OFF also disables the alarm for the timeout of the APO function and the Bell function sound.



8-2-14 Bell function setting

The Bell function informs you with a bell sound when a signal is received.

- 1 Select Set menu No. 14, "bELL".



- 2 Rotate the dial to switch between "OFF" and "ON".

When this function is set to ON, the  appears on the LCD. When a signal is received, the  blinks and a bell sounds. Since the  continues blinking until the next key operation, this function can also be used as a "signal reception notification" when you leave the DJ-X30 momentarily.

8-2-15 Monitor Key Operation setting

You can set the operation performed when the [MONI] key is pressed.

- 1 Select Set menu No. 15, "Moni".

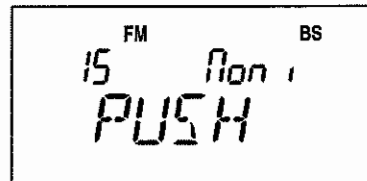

- 2 Rotate the dial to select either "PUSH" or "HOLD".

PUSH	The Monitor/Mute function is valid only while the [MONI] key is pressed.
HOLD	The Monitor/Mute function is valid from the instant the [MONI] key is pressed until the key is pressed again.

8-2-16 Monitor/Mute function setting

You can set the role of the [MONI] key, to either activate the Monitor function or the Mute function.

- 1 Select Set menu No. 16, "Moni".



- 2 Rotate the dial to select either "MONI" or "MUTE".

MONI	When the [MONI] key is pressed, the squelch opens temporarily.
MUTE	When the [MONI] key is pressed, sound is muted temporarily.

8-2-17 Charging function setting

- 1 Select Set menu No. 17, "CHARGE".



- 2 Rotate the dial to switch between "ON" and "OFF".
The default is OFF.

CAUTION ! This setting is very important. Be sure to read this information carefully.

- You must set the Charging function to OFF when dry cell batteries are used. When this function is ON, the dry cell batteries will be charged, which is extremely dangerous.
- Charging is automatically turned OFF after a specified time to prevent overcharging. The charging time can be changed with the "Charging time setting" in Set mode.
- Stop charging immediately if any abnormality is found such as leak odor and heat produced from the battery.

8-2-18 Charging time setting

This function sets the charging time according to the battery capacity when the optional Ni-MH battery pack (EBP-57N) or commercially-available rechargeable AA-size batteries are used.

The time can be set within the range of 1 to 24 hours.

- 1 Select Set menu No. 18, "CHGtiM".

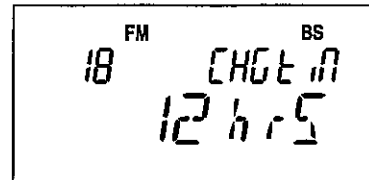

- 2 Rotate the dial to set a charging time.



- The optional Ni-MH battery pack (EBP-57N) requires about 10 hours to be fully charged.

Batteries with larger capacity than the optional EBP-57N require a longer charging time.

Relationship between major commercially-available Ni-MH batteries and typical charging time is:

1800 mA: 12 hours

2200 mA: 14 hours

- After charging is complete, turning OFF the DJ-X30 and turning it ON again will start charging again.

8

8-2-19 Set Mode cancel time setting

This function sets whether or not to exit the Set mode automatically when no operation is performed for a specified time. You can select either manual canceling or automatic canceling (5 to 25 seconds).

- 1 Select Set menu No. 19, "SetMod".

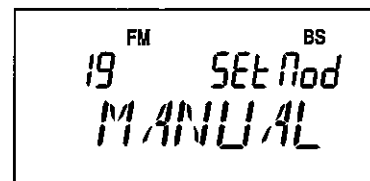

- 2 Rotate the dial to change the display between "MANUAL" and "5-SEC" through "25-SEC".

MANUAL (Default)	The Set mode continues until the [FUNC] key is pressed.
"5-SEC" to "25-SEC"	The Set mode is automatically terminated when no operation is performed for the specified time. The change in the setting will be saved.

67

8-2-20 Write-protect (memory protection) function setting

You can enable editing (overwriting or deleting) for the channel data programmed for the Memory mode.

- 1** Select Set menu No. 20, "ProtCt".



- 2** Rotate the dial to switch between "ON" and "OFF".

ON	Write-protect is enabled. You cannot edit the programmed data in the memory.
OFF	Write-protect is disabled. You can edit the all data in the memory.

To delete a memory channel, continue the procedure shown in "Deleting a memory channel" (P. 38).



• When you activate the Reset function while the write-protect function is disabled, all data in the memory will be deleted. After you edit the memory by disabling the write-protect function, be sure to activate the function again. The back-up memory is not available in the DJ-X30. Please use the editor software (P. 38) if you wish to back-up the data.

8-2-21 Skip-scan Operation setting

You can select whether to skip the frequency programmed to the skip-search memory channel and the memory channel specified for skip operation.

The frequencies programmed to the skip-search memory channel are skipped during the VFO scan, programmed scan, and preset scan (excluding TV frequencies). The memory channels specified for skip operation are skipped during the memory scan.

During the memory scan, the frequencies programmed to the skip-search memory channel are not skipped.

- 1** Select Set menu No. 21, "SCAN".

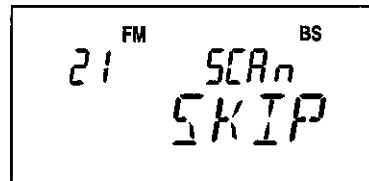

- 2** Rotate the dial to select either "SKIP" or "NoSKIP".

SKIP..... The scan excludes the channels specified for skip operation.

NoSKIP..... The scan includes the channels specified for skip operation.

8

8-2-22 Wild Key assignment setting

You can assign a desired menu of the Set mode to the  key. By assigning a frequently used menu to the key, you can change its setting quickly.

- 1** Select Set menu No. 22, "YLdbtn".

Menu number of the function assigned to the key

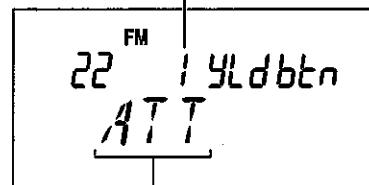

Menu item of the function assigned to the key

2 Rotate the dial to display the functions which can be assigned to the  key one by one.

You can select a menu item from the following:

Menu No.	Menu name	Description
1	ATT	Attenuator (ATT) function setting
2	ANTENA	Earphone Antenna setting
3	ABAR	AM Radio Bar-antenna setting
4	SBAR	Shortwave Bar-antenna setting
5	LAMP	Lamp Operation setting
6	SCANTP	Scan Type Switching setting
7	PRIO	Priority Channel setting
8	TIMESP	Priority Monitoring interval setting
9	TIMEPR	Priority Monitoring duration setting
10	BAND	Band Transition setting
11	APO	APO function setting
12	BS	Battery-save function setting
13	BEEP	Beep deactivation setting
14	BELL	Bell function setting
15	MONTYP	Monitor Key Operation setting
16	MONFNC	Monitor/Mute function setting
17	CHARGE	Charging function setting
18	CHGTIM	Charging time setting
19	SETMOD	Set Mode cancel time setting
20	PROTCT	Write-protect (memory protection) function setting
21	SKIP	Skip-scan Operation setting
22	WILDKY	Wild Key assignment setting
23	RMCN-A	Function assignment for Remote Controller Key A
24	RMCN-B	Function assignment for Remote Controller Key B
25	RMCN-C	Function assignment for Remote Controller Key C
26	RMCN-D	Function assignment for Remote Controller Key D
27	qiq-PS	Quick Programmed scan Channel Selection

8-2-23 Function assignment for remote controller buttons

This menu is available only when the optional remote controller EDS-12 is used. You can assign the functions listed in the table below to the remote controller keys as desired. The remote controller has four keys for function assignment: A through D.

- 1 Use Set menu No. 23 through 26 to assign functions to remote controller keys A through D respectively. The operation is common to all keys.**

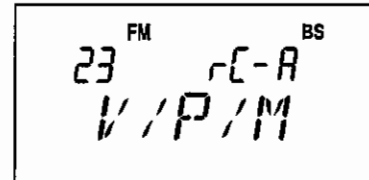

- 2 Select a key to assign a menu item by selecting from Set menu No. 23 through 26. "rC-A", "rC-b", "rC-C", or "rC-d" is displayed on the LCD.**

The letters "A", "b", "C", and "d" on the right end indicate the operation keys of the remote controller.

- 3 Rotate the dial until the function you wish to assign to the selected key appears.**

The following functions can be selected.

Default	Menu name	Description
	ATT	Attenuator (ATT) function setting
	ANTENA	Earphone Antenna setting
	ABAR	AM Radio Bar-antenna setting
	SBAR	Shortwave Bar-antenna setting
	BEEP	Beep deactivation setting
	BELL	Bell function setting
KEY C	UP	UP key
KEY D	DOWN	DOWN key
KEY A	V/P/M	VFO/Preset/Memory mode switching
	AUX IN*	External input switching
	TONE	Tone Squelch function setting
	REVTON	Reverse Tone Squelch function setting
	DESCR	Descrambling function setting
	MONI	MONI (Monitor) key
KEY B	BAND	Band switching
	PRIO	Priority Monitoring function setting
	SPEED	Scan Speed switching function setting
	AFTONE	Audio quality of received signals setting

* This function selects whether to switch to the DJ-X30 automatically when the squelch opens, or to manually switch the audio input from the portable audio player.

8-2-24 Quick programmed scan channel selection

Select a channel for the quick programmed scan. This function is enabled when the programmed scan channel(s) has been programmed in Memory mode.

- 1** Select Set menu No. 27, "qiq-PS".
- 2** Rotate the dial to select the desired channel.



9. Channel Display Mode

This mode displays only a bank and a channel number instead of a frequency in the Memory mode. Some other functions are also disabled.

- 1** Program frequencies into the memory beforehand.
- 2** Select the memory mode and turn the power OFF.
- 3** Turn the power ON while holding down the [MONI] and  keys simultaneously.

The LCD should appear like the figure on the right showing the bank and channel number.

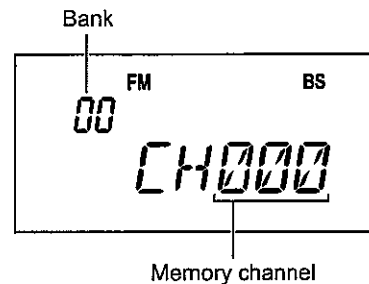

To cancel the Channel Display mode:
Repeat the same operation as above.



MEMO

- In the Channel Display mode, all operations are disabled except for bank/channel selection, volume adjustment, squelch adjustment, Monitor/Mute function, Memory Scan, and Key-lock. The reset won't delete the channel data in this mode.

10. Using the Optional Remote Controller

10-1 Using the Remote Controller EDS-12

10-1-1 Top/Bottom/Front panels

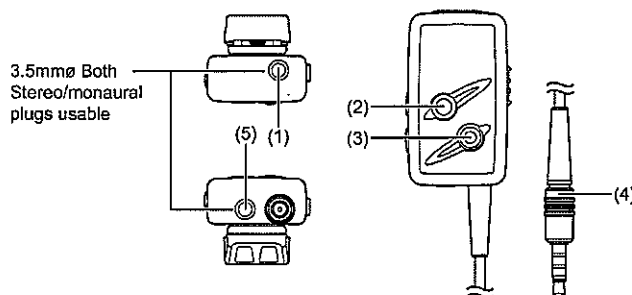

No.	Item	Description
(1)	Earphone jack	Earphone output jack. Connect optional earphones or other output devices.
(2)	Operation key A	Assigned to the V/P/M key as default.
(3)	Operation key B	Assigned to BAND key as default.
(4)	Earphone cord	Plug this cord into the earphone jack of the DJ-X30.
(5)	Audio input jack	Connect an MP3 player or other portable audio player using its appropriate AUX in/output accessory cable.

10-1-2 Side panel

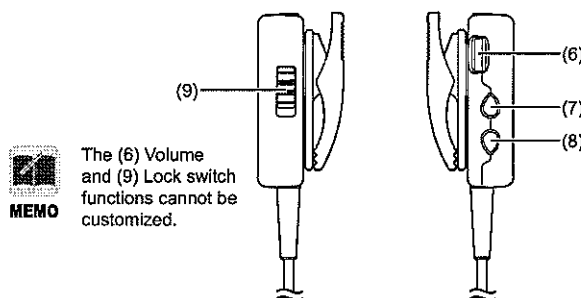

No.	Item	Description
(6)	Volume control	Used to adjust the volume of DJ-X30. The volume of connected audio device from the audio input jack (5) cannot be changed.
(7)	Operation key C	Assigned to the UP key as a default.
(8)	Operation key D	Assigned to the DOWN key as a default.
(9)	Lock switch	Used to lock the keys of the remote controller.

10-2 Connecting the Remote Controller

The following figure shows the connection of the remote controller.

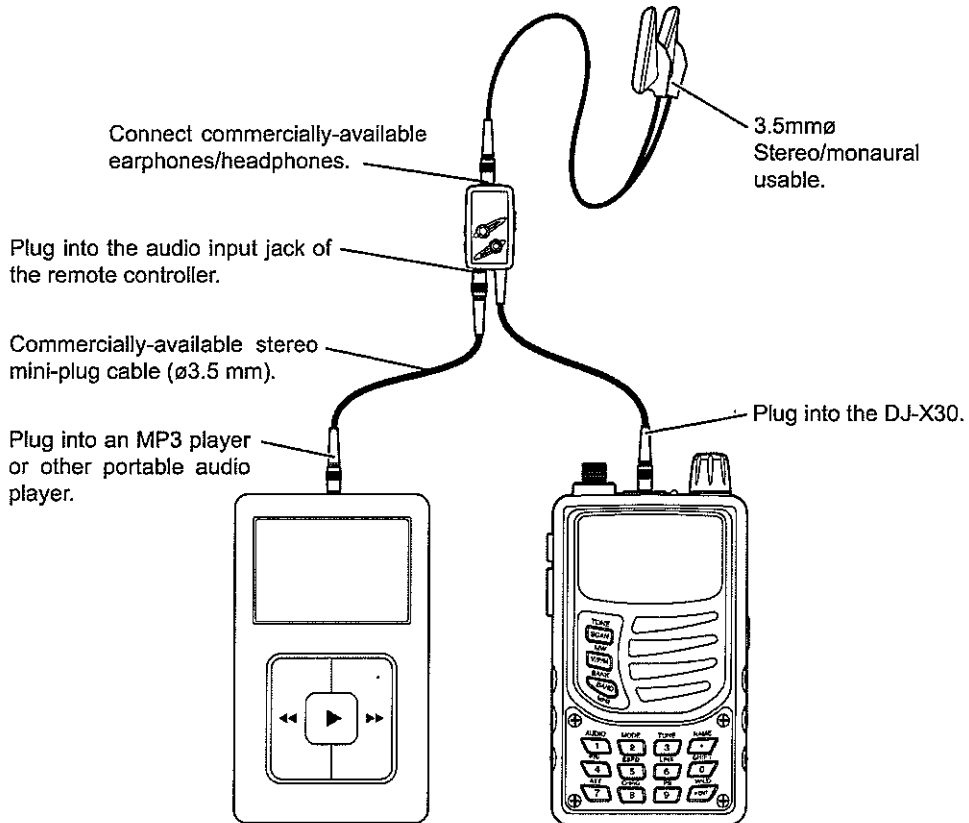

10-3 Remote Controller Functions

10

- Both monaural and stereo earphones/headphones can be used.
- You can connect an MP3 player or other portable audio player to the remote controller and listen to music. When the squelch opens, the input is automatically switched to the DJ-X30.
- You can assign functions you wish to the operation keys A, B, C and D. (See page P. 71)

75

11. Cable-clone and PC Connection Functions

The Cable-clone function copies data from one DJ-X30 to another DJ-X30. By connecting two DJ-X30 units with a cable, you can copy the information (including memory data) specified in the sending unit (herein referred to as "Master") to the receiving unit (herein referred to as "Slave").

You can also edit memory channels and Set mode settings with free software downloadable from Alinco's web site, by connecting the DJ-X30 to a PC using the PC Connection cable ERW-4C or ERW-7.

11-1 Cable Connection (An optional cable necessary)

Before connecting the cable, you must turn OFF the power of the DJ-X30. Connect the earphone jacks on the Master and Slave with a commercially available $\varnothing 3.5\text{mm}$ stereo mini-plug cable. When you connect the DJ-X30 to a PC, use the PC interface cable (optional; ERW-4C or ERW-7). Plug the socket of the cable to the serial or USB port on the PC, and plug the other end into the earphone jack on the DJ-X30.

- 4-pole stereo mini-plug cable

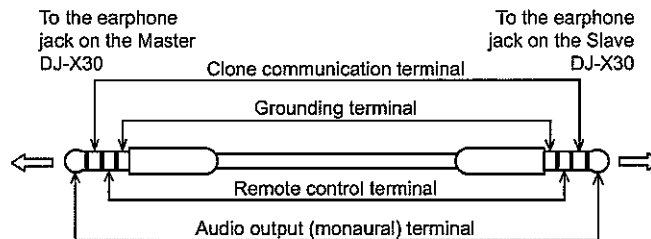

- 3-pole stereo mini-plug cable

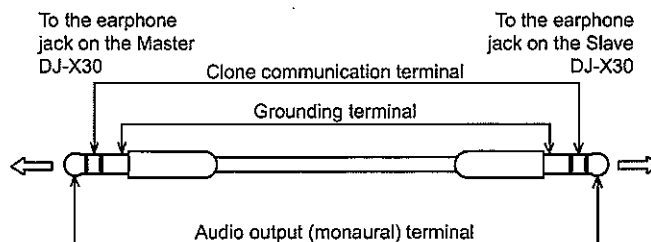

Both 4-pole and 3-pole cables are equally usable for cable-cloning. The description above explains the circuit configuration for reference purposes only.

11-2 Receiving Data

Use the following procedure to copy data from another DJ-X30 or to receive data edited on a PC.

1 Turn OFF the Slave and connect the stereo mini-plug cable to its earphone jack.

2 While holding down the [MONI] key, press the [PWR] key to turn ON the Slave.

"CLONE" appears on the LCD and the Slave enters Clone mode.



3 Wait until the Master DJ-X30 or PC sends data.

4 When the data transfer finishes, "FINISH" is displayed on the LCD. Confirm the display and turn OFF the Slave.



CAUTION

- The stereo mini-plug cable should be a direct-coupled type which avoids internal resistance.
- While the Master is transferring data, pressing any key on the Slave suspends the data transfer operation. To resume the operation, press the dial.
- Do not unplug the cable while data is being transferred. Doing so will suspend the data transfer operation, and "FAIL" will be displayed on the Master's LCD.
- Note that the cloning procedure overwrites all data stored in the Slave with the Master's data. Make sure that the Slave does not have any necessary data.

11-3 Transferring Data

The procedure below does not necessitate using the PC Connection function.

- 1 Turn OFF the Master and connect the stereo mini-plug cable to its earphone jack.**
- 2 While holding down the [MONI] key, press the [PWR] key to turn ON the Master.**

"CLONE" appears on the LCD and the Master enters Clone mode.

- 3 While "CLONE" is displayed on the LCD, press the dial. The LCD shows something like the figure on the right and the data on the Master is transferred to the Slave.**

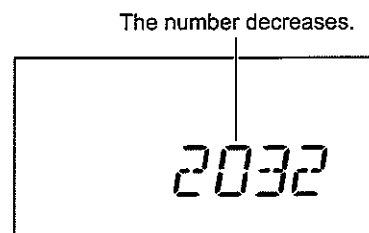

- 4 When the data transfer finishes, "FINISH" appears on the LCD.**

If "FAIL" appears on the LCD, repeat the procedure from step 1.

- 5 Turn OFF the Master.**

The Clone mode is not canceled unless you turn OFF the Master.



To copy the data stored in the DJ-X30 to PC using the editor-software also requires that the unit is set to the "CLONE" status.

12. Reset Function



CAUTION

- Before resetting the DJ-X30, be sure to check the memory protection function settings. Resetting the receiver with the Write-protect (memory protection) function (P. 68) in OFF state deletes all of the factory default data and user-programmed data.
- You cannot restore data after it is deleted.

The Reset function resets all values and parameters including the Set mode settings to the initial (factory default) settings.

12-1 Reset Procedure

- 1** While holding down the [FUNC] key, hold down the [PWR] key and turn the DJ-X30 ON.
- 2** When all icons and indicators are displayed on the LCD, release the [FUNC] and [PWR] keys.

The DJ-X30 returns to the initial VFO mode.

12-2 Default Settings

List of data after resetting (Factory default parameters)

Frequency	VFO mode, 145.000 MHz
Volume level	20
Squelch level	3
Preset mode	88.1 MHz: T 87.6 MHz: E/EGR
Scan	VFO scan
Memory scan	SINGLE scan
Tuning step frequency	AUTO
Descrambling code No. (E)	11
CTCSS tone frequency	88.5
Set mode	
Attenuator (ATT) function setting	OFF
Earphone Antenna setting	External antenna
AM Radio Bar-antenna setting	ON
Shortwave Bar-antenna setting	ON
Lamp Operation setting	5-SEC
Scan Type Switching setting	Busy scan
Priority Channel selection	0 channel
Priority Monitoring interval setting	5-SEC
Priority Monitoring duration setting	BUSY
Band Transition setting	ROTATE (within the current band)
APO function setting	OFF
Battery-save function setting	ON
Beep deactivation setting	ON
Bell function setting	OFF
Monitor Key Operation setting	PUSH
Monitor/Mute function setting	MONI
Charging function setting	OFF
Charging time setting	12 hours
Set Mode cancel time setting	MANUAL
Write-protect (memory protection) function setting	ON
Skip-scan Operation setting	SKIP
Wild Key assignment setting	SMA/ (EAR)
Function assignment for Remote Controller Key A	V/P/M
Function assignment for Remote Controller Key B	BAND
Function assignment for Remote Controller Key C	UP

12. Reset Function

Function assignment for Remote Controller Key D	DOWN
Quick Programmed Scan Selection	0A
Key pad mode	
Modulation mode	AT
Shortwave Tuning function	AUTO
Scan speed (V-SPD)	Speed 3
Scan speed (M-SPD)	Speed 3
Audio quality of received signals setting	LOW

13. Maintenance and Reference

13-1 Troubleshooting

Please check the list below before concluding that the receiver is faulty.
If a problem persists even after performing the actions below, try resetting the receiver. This may correct erroneous operations.

Symptom	Possible Cause	Action
Nothing appears on the LCD when you turn the power ON.	Poor battery contact	Check that the battery terminals are clean.
	Flat batteries	Recharge the battery pack or replace dry-cell batteries with new ones.
	Releasing the [PWR] key too quickly	Press the [PWR] key for 1 second until the receiver turns on.
No speaker audio/ No reception	Volume level is too low.	Adjust the volume level.
	Squelch level is too high.	Adjust the squelch level.
	Tone Squelch is ON.	Deactivate the Tone Squelch.
	Mute function is ON.	Deactivate the Mute function.
Frequency display is incorrect.	CPU error	Uninstall the batteries or unplug the external power supply. Wait for at least 10 seconds, and reinstall the batteries or reconnect the power supply. If the problem persists, reset the receiver.
The receiver does not scan.	Squelch is open.	Adjust the squelch level until noise disappears.
Frequency and memory channel number do not change.	Key-lock is ON.	Release the Key-lock.
Keys do not operate.	Key-lock is ON.	Release the Key-lock.
Display blinks or goes out during reception.	Flat batteries	Recharge the battery pack or replace the dry-cell batteries with new ones.

13-2 Optional Accessories List

- Soft Case (ESC-44)
- Curl-Cable Earphone (EME-26)
- Straight Cable Earphone (EME-6)
- Cigar DC/DC Converter (EDH-33)
- Trickle Stand Charger (EDC-154A, EDC-154E, EDC-154EUK)
- Ni-MH Battery Pack (EBP-57N: 1.2 V-1800 mAh x 2)
- Remote Controller (EDS-12)
- PC Programming Cable (ERW-4C: for serial port connection)
- PC Programming Cable (ERW-7: for USB connection)

13-3 Table of Available CTCSS Tones

The table below shows the CTCSS tones available for the Tone Squelch function.

Rotate the dial while a tone frequency is displayed on the LCD to select CTCSS tones from the following 39 standard tones.

67.0	94.8	131.8	186.2
69.3	97.4	136.5	192.8
71.9	100.0	141.3	203.5
74.4	103.5	146.2	210.7
77.0	107.2	151.4	218.1
79.7	110.9	156.7	225.7
82.5	114.8	162.2	233.6
85.4	118.8	167.9	241.8
88.5	123.0	173.8	250.3
91.5	127.3	179.9	

(Unit: Hz)

14. Index

NUMBER

10MHz/1MHz UP/DOWN 33

A

AC adapter 19, 20
 Accessories 14, 15
 All-bank scan 41
 AM 49
 APO 63
 Attenuator (ATT) 59
 Audio quality of received signals 48
 AUX IN (Audio input) 71, 74

B

BAND 22, 24
 Band transition 63
 Bank 35, 36
 Bar-antenna 60
 Batteries 17, 18, 66, 67
 Battery indicator 18, 20
 Battery-save 64
 BEEP 64
 BELL 65
 Belt clip 15
 Busy scan 61

C

Channel Display mode 73
 Charging 18, 20, 66, 67
 Cloning 76
 CTCSS 44

D

Data transfer 77
 DC jack 23
 Descrambling 45
 Dial 22

E

Earphone antenna 59
 Earphone jack 22
 ENT 25
 External antenna 15, 59, 60

F

Face-Panel 17
 FM 49
 Frequency shift 55, 56
 FUNC 23

G

Group 54, 55
 Group scan 41

H

HOLD 29, 65

K

Key pad 22, 47
 Key pad cover 16
 Key-lock 43

L

LAMP 61
 LCD 26

M

Memory bank.....	35
Memory channel.....	36
Memory mode.....	30, 35
Memory Naming.....	50
Memory Scan.....	41
Memory Skip.....	42
Modulation Mode.....	48
MONI.....	23, 28, 66
Monitor.....	29, 66
Mute.....	29, 66

N

Ni-MH battery pack.....	18, 20, 67
-------------------------	------------

P

PC connection.....	76
Preset mode.....	30, 34
Preset scan.....	39, 40
PRGRM.....	42
PRI.....	52
Priority Monitoring.....	51
Programmed scan.....	39, 42
PWR.....	23

Q

Quick Programmed scan.....	57
----------------------------	----

R

Remote controller.....	71, 74
Reset.....	79
Reverse Tone Squelch.....	44
Rubber cushion.....	14, 17
RX lamp.....	22, 61

S

Scan.....	39
Scan speed.....	53
Scan type.....	61
Set mode.....	58
Set mode cancel time.....	67
Shortwave Tuning function.....	49
Single-bank scan.....	41
SKIP.....	42

Skip-scan.....	69
Skip-search.....	35, 36
SMA.....	22
SPd.....	53
Speaker.....	22
Specifications.....	86
Squelch.....	28
Strap.....	16

T

Timer scan.....	61
TLEVEL.....	49
TONE.....	44, 83
Tone Scan.....	46
Tone Squelch.....	44
Trickle Charger.....	20, 21
Tuning step.....	32

V

V/P/M.....	22, 24
VFO mode.....	30
VFO scan.....	40
Volume.....	27, 74

W

WAV.....	48
WFM.....	49
WILD.....	69
Write-protect (memory protection).....	68

15. Specifications

Receiver range		0.100~1299.995MHz continuous (USA T version: cellular frequencies [824.000~849.995MHz, 869.000~894.995MHz] are blocked.)
Modulation type	AM	A3E
	FM/WFM	F3E
Antenna impedance		50Ω unbalanced SMA port
Operating battery voltage	External DC port	DC5.4V~6.0V
Current consumption	Average	Approx. 140mA
	Stand-by	Approx. 80mA
	Battery-save ON	Approx. 26mA
Frequency stability		-7~+3ppm (-10°C~+60°C) (+14°F~+140°F)
Size		58W×99H×32D mm/2.28W×3.90H×1.26D inches (projection exclusive)
Weight		Approx. 165g/15.83oz (antenna and battery inclusive)
Receiver	NFM/AM	Triple-conversion Super-heterodyne
	WFM	Double-conversion Super-heterodyne
Intermediate frequency	1st	243.95MHz
	2nd	39.15MHz (NFM/AM), 10.7MHz (WFM)
	3rd	450kHz (NFM/AM)
Sensitivities (*)	FM	30~470MHz: -15dBμ (0.17μV) 470MHz or higher: -7dBμ (0.45μV) 12dBSINAD
	WFM	76~470MHz: -6dBμ (0.5μV) 470MHz or higher: -3dBμ (0.7μV) 12dBSINAD
	AM	0.1~50MHz: -1dBμ (0.89μV) 50MHz or higher: -6dBμ (0.5μV) 10dB S/N
Selectivity	NFM/AM	-6dB/12kHz or more -60dB/35kHz or less
	WFM	-6dB/130kHz or more -60dB/300kHz or more
Audio output power		More than 100mW (8Ω)

* Typical values in the bands, not the minimum guaranteed values.



ALINCO, INC.

Head Office: Shin-Dai building 9th Floor
2-6, 1-Chome, Dojimahama, Kita-ku, Osaka 530-0004, JAPAN
Phone: +81-6-4797-2136 Fax: +81-6-4797-2157
E-mail: export@alinco.co.jp

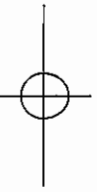

Printed in Japan
Copyright Alinco, Inc. PS0542/FNNJ-EF

