

# FT-890

## OPERATING MANUAL

Downloaded by   
RadioAmateur.EU

**YAESU MUSEN CO., LTD.**

C.P.O. BOX 1500

TOKYO, JAPAN

YAESU

# Contents

<b>Front Panel . . . . .</b>	<b>Fold-Out</b>	
<b>Meter Functions, Top Panel Controls &amp; Display . . . . .</b>	<b>Fold-Out</b>	
<b>Specifications . . . . .</b>		<b>2</b>
<b>Accessories &amp; Options . . . . .</b>		<b>3</b>
ATU-2 & FC-800 Automatic Antenna Tuners		3
TCXO-3 Master Reference Oscillator		3
SP-6 Loudspeaker and LL-5 Phone Patch Option		3
YH-77ST Lightweight Headphones		4
DVS-2 Digital Voice System		4
FIF-232C CAT System Interface		4
IF Crystal Filter Options		4
Microphones		5
<b>Station Installation . . . . .</b>		<b>6</b>
Preliminary Inspection		6
AC Power Supply		6
Changing the AC Voltage Range of the FP-800		6
Transceiver Location		7
Grounding		7
Adjusting the Front Panel Angle		7
Antenna Considerations		7
Mobile Power Connection		7
Mobile Mounting		8
Mobile Antenna Installation		8
Interconnection of Accessories		8
Memory Backup		8
<b>Connector Pinouts . . . . .</b>		<b>9</b>
<b>Connecting External Accessories . . . . .</b>		<b>10</b>
<b>Connecting a Linear Amplifier . . . . .</b>		<b>11</b>
<b>Power-Up Settings . . . . .</b>		<b>12</b>
<b>Operation . . . . .</b>		<b>13</b>
<b>Getting Started Tutorial . . . . .</b>		<b>13</b>
Tuning & Scanning Steps		13
General Coverage Reception		14
Displaying the 10's-of-Hz Digit		14
Button Beeper Settings		14
<b>Dealing with Interference . . . . .</b>		<b>14</b>
Front End Selections: RF Amp & Attenuation		14
RF Gain Setting		15
AGC-F Selection		15
Noise Blanker Setting		15
IF Shift Adjustment		15
AM & CW Narrow IF filters		15
Locking the Dial or Buttons		15
IF Notch Filter		16
YF-101 SSB Crystal Filter Option		16
<b>Transmitting . . . . .</b>		<b>17</b>
Automatic Antenna Matching		17
SSB Transmission		17
Microphone Tone Selection		18
AF Speech Compressor		18
IF Processor Frequency Shift		18
VOX (Voice-Actuated T/R Switching)		19
CW Transmission		19
CW Key or Paddle Connections		19
Using the Internal Electronic Keyer		20
Sidetone & Button Beeper Volume		20
AM Transmission		20
FM Transmission		20
FM Repeater Operation		21
Clarifier (Receiver Offset Tuning)		21
VFO B & Split Frequency Operation		21
Tuning Knob Torque Adjustment		22
<b>Memory Features . . . . .</b>		<b>23</b>
Memory Storage		23
Checking Memory Contents		23
Frequency Display Modes		24
Clarifying Memories, and <b>M TUNE</b>		24
Memory Recall & Operation		24
Memory Scanning		25
Memory Scan Skip		25
Memory Blanking		25
Subband Scanning: Memories P1 & P2		25
<b>Digital Modes . . . . .</b>		<b>27</b>
TU/TNC Interconnections		27
Transmitter AF Input Relationships		28
Transmitter Adjustment		28
Frequency Display & Tuning		28
1200-Baud FM Packet		29
<b>Optional DVS-2 Digital Voice Recorder . . . . .</b>		<b>30</b>
<b>CAT System Computer Control . . . . .</b>		<b>31</b>
Data Returned From FT-890		31
Status Update Data Organization		31
CAT Commands		32
Coding Examples		34
<b>Installing Internal Accessories . . . . .</b>		<b>35</b>
Cover Removal		36
TCXO-3 Enhanced-Stability Oscillator		37
Optional IF Crystal Filters		39
ATU-2 Internal Antenna Tuner		39
<b>Rear Panel . . . . .</b>		<b>42</b>

The meter indicates the selected parameter during transmission, and signal strength in S-units during reception (on the top scale). Each S-unit is approximately 6 dB. See the back of this page.

This button activates split frequency transceive operation. The displayed frequency is used for reception, and the other VFO or rear half of the memory for transmission. The **SPLIT** indicator at the left side of the display is lit while this function is active.

One of these indicator/buttons is always lit to indicate the function of the multimeter during transmission. Press an indicator to change the selection. The meanings of the abbreviations are as follows:

**ALC** relative Automatic Level Control  
**PO** RF Power Output (watts)  
**SWR** Standing Wave Ratio

The **TX** LED glows red when the transmitter is activated. The **BUSY** LED glows green when the squelch is open.

The display indicates operating frequency, clarifier offset, memory number and special states. Details are on the back of this page.

These five momentary buttons select the operating mode, indicated by the LED in each button.

This button can be used to manually activate the transmitter. It must be in the undepressed (■) position for reception.

Enables automatic voice-actuated transmitter switching in voice modes. Related controls are on the rear panel, and operation is described on page 19.

This button turns the transceiver on and off. To avoid switching spikes, make sure it is off when you turn the DC power source (AC power supply) on or off. In a mobile installation, the transceiver should be off when starting or stopping the engine.

This 1/4-inch, 3-contact jack accepts either monaural or stereo headphones with a 2- or 3-contact plug. When a plug is inserted, the loudspeaker is disabled. Audio is supplied to both channels of a stereo headphone.

This 8-pin jack accepts the MD-1B<sub>B</sub> or MD-1C<sub>B</sub> Desktop Microphone or the MH-1B<sub>B</sub> Handie Scanning Microphone. Proper microphone input impedance is 500 to 600 ohms.



Each of these buttons has an LED indicator to show when the function is activated.

**PROC** activates the speech processor in the SSB and AM modes. See page 18.

**AGC-F** sets the receiver Automatic Gain Control decay time for fast recovery, which can improve CW reception and fast-fading (QSB) SSB signals.

**IPO** bypasses the receiver RF amplifier, providing the widest dynamic range. See page 14 for details.

**ATT** If the IPO function is on and the band is noisy or very strong signals are present, press this button to insert a 12-dB attenuator in the front end to protect the receiver from overload.

**RPT** activates HF FM repeater operation on the 29-MHz band. See page 21.

The inner **AF** gain control adjusts the volume of the receiver in the speaker or headphones.

The outer **RF** gain control adjusts the gain of the receiver IF amplifiers. This control is normally set fully clockwise for maximum sensitivity. See page 15 for details.

The inner **MIC** control adjusts the microphone input level for SSB and AM transmission.

The outer **RF PWR** control sets transmitter output power in all modes. The adjustment range is from less than 10 to 100 watts (5 to 25 watts AM).

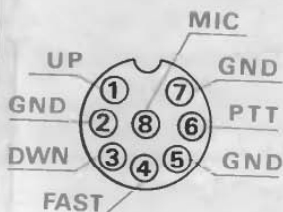

# Front Panel

This button toggles operation between a memory and a VFO. Either **VFO-A** (or **-B**), or **MEM** is displayed to the left of the frequency to indicate the current selection. If a displayed memory has been retuned, pressing this button once returns the display to the original memory contents, and pressing it again returns to the (last used) VFO.

Pressing this button while receiving in a ham band activates the transmitter for while the tuner rematches the antenna for minimum SWR. The resulting settings are stored in the antenna tuner's 31 memories, for automatic recall later. See page 17.

When receiving on a VFO, this button toggles operation and display between VFOs A and B. On a memory, it toggles front and rear halves.

Pressing this button so that its LED is lit puts the antenna tuner in line. Reception is not affected. The **START** button also activates the antenna tuner.

Pressing this button momentarily displays the contents of the currently selected memory channel for three seconds. Holding this button for 1/2 second copies all data from the memory to the VFOs, as two beeps sound. Previous data in the VFOs is overwritten. See page 24.

When receiving on a VFO or a retuned memory, holding this button for 1/2-second writes the current operating data to the currently selected memory. Two beeps sound, and any previous data in the memory is overwritten. Also, pressing and holding this button after recalling a memory (without retuning) causes the memory to be "blanked." Repeat to unblank the memory.

This button copies the contents of the display to the other VFO or memory half. Previous contents of the non-displayed VFO/memory half are overwritten (*lost!*).

This knob tunes the clarifier offset frequency up to  $\pm 9.99$  kHz, when activated by the **CLAR** button to the left of it. Operating details are on page 21.

Pressing either of these buttons momentarily steps the operating frequency down or up one ham band, or 100 kHz (if receiving in GEN mode), respectively. Pressing **FAST** with one of these buttons steps down or up 1 MHz if receiving in GEN mode. Continue holding either button for repeated stepping.

The inner **NOTCH** control adjusts the IF notch frequency when activated by the button/LED next to the label. In modes other than AM and FM, the outer **SHIFT** control offsets the IF passband center frequency from the displayed frequency when turned away from the 12-o'clock position.

The outer **SQL** control sets the signal threshold at which receiver audio is muted (and the **BUSY** LED turns off), in all modes. This control is normally kept fully CCW, except when scanning, and during FM operation. Scanning stops when the squelch is open. See page 25.

The inner **NB** control adjusts the blanking level when the noise blander is activated by the indicator/button left of the label. If the control is set very far clockwise, receiver audio may be distorted.

This knob tunes the operating frequency of the VFO or a recalled memory. Tuning increments are normally 10 Hz (100 Hz in AM and FM modes). The markings on the knob represent 25 increments each, and one full turn of the knob provides 500 increments (5 kHz, or 50 kHz in AM/FM).

This button determines the function of the **DOWN/UP** buttons when receiving on a VFO or retuned memory: GEN steps are 100 kHz, and HAM steps are from one amateur band to the next.

This button toggles locking of the tuning knob to prevent accidental frequency changes. **LOCK** appears at the bottom left of the display window when locked (the knob can still be turned, but it does nothing). Press again to re-enable the tuning knob. You can change the function of this button to lock most of the controls and buttons, instead of just the tuning knob, by holding the button while switching the transceiver on. In this case the **LOCK** display will blink when enabled.

For fast tuning, press this button while rotating the tuning knob or pressing the **UP** or **DOWN** button, to increase the tuning rate ten times. See the table on page 13 for all available steps. When fast tuning is active, **FAST** is displayed above the MHz digits. You can set the function of this button to be either "press-and-hold", or toggle on/off, by holding it while switching the transceiver on.



# Meter Functions

During reception, the top "S" scale indicates incoming signal strength in S-units at the left end of the scale, and in dB above S-9 at the right end. Each S-unit is approximately 6 dB.

*Note: While receiving, refer only to the S-meter function: the top scale of the meter.*

*While transmitting, the meter function is determined by the METER button/LEDs below it. One of these is always lit (even while receiving) to indicate the transmit function of the meter.*

The second, "PO" scale indicates transmitter power output, in watts, when selected by the METER button/LED with the same name. This scale is calibrated to be most accurate when the antenna impedance is 50-Ω. Refer only to the numbers above the scale (0 - 150) for the FT-890; the numbers below apply only to special low-power versions.

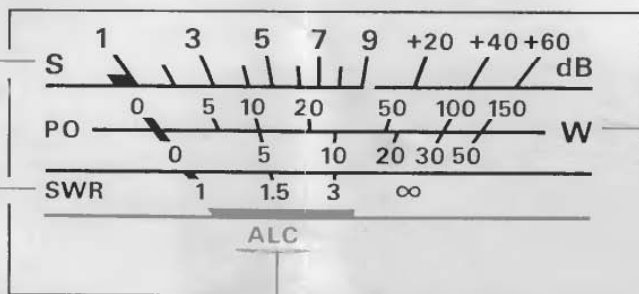

The "SWR" scale indicates the standing wave ratio at the antenna jack, as a ratio of forward to reflected power, when selected by the METER button/LED with the same name. A perfectly matched antenna should give no deflection. If the SWR is above 3, the antenna requires matching.

The bottom "ALC" scale indicates transmitter Automatic Level Control voltage when selected by the METER button/LED with the same name. The position and movement of the meter needle give a good indication of transmitter performance. This meter function is important when setting the MIC gain control for SSB and AM modes, and the RF PWR control in CW and FM modes. See the Transmitting instructions beginning on page 17.

# Top Panel Controls

This 3-position slide switch activates the internal electronic CW keyer (in the AUTO or WT positions), and selects heavy (1:4.5) dot:dash weighting in the WT position. In the MAN position, the internal keyer is disabled. Keyer operation is described on page 20.

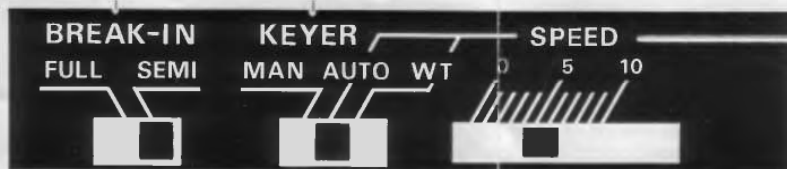

For CW operation (with or without the internal keyer) this switch selects the type of transmit/receive switching between code elements. Select the FULL position for full break-in (QSK), if you want the receiver to be activated between each dot and dash. Select the SEMI position if you want the receiver to be activated only when you pause while sending. Related adjustments are described on page 20.

This slide potentiometer adjusts the speed of the internal electronic CW keyer, when the KEYSER switch is set to either AUTO or WT position.

# Display

One of these segments lights along with the TONE indicator when the repeater function (RPT/T button) is activated in the FM mode, indicating the direction of repeater offset. TONE indicates the CTCSS tone is also activated to access CTCSS-controlled repeaters (page 21).

This indicator appears whenever the fast (x 10) tuning rate is activated by the **FAST** button below the tuning knob.

This indicator appears when the automatic antenna tuner detects an abnormally high SWR that it cannot match.

This indicator appears while the automatic antenna tuner is seeking an impedance match with the antenna. It also flashes each time the main microprocessor sends frequency update data to the tuner microprocessor (while you tune).

(NARrow IF filter) While operating in the AM or CW mode, pressing the **AM** or **CW** button, respectively, toggles this indicator and the narrow IF filter for that mode (CW narrow requires an optional filter). Press the same button again to return to the wide IF filter.

This indicator appears when the Clarifier (receiver offset) is activated by the **CLAR** button. Remember that your transmit frequency may be different from the display when this indicator is visible!

This indicator blinks after pressing the **M** → **VFO** or **VFO** → **M** button, to indicate that Memory CheckIng is active. While it is blinking, you can press the **DOWN/UP** buttons to check the contents of memories, without affecting operation. Wait 3 seconds and Memory CheckIng stops. See page 23.

While selecting memories during Memory CheckIng, this indicator appears when the selected memory is vacant. The frequency display is blank.

**WAIT**  
**HI SWR**

**SPLIT**

**GEN**

**LOCK**

**VFO-A**

**VFO-B**

**MEM**

**M TUNE**

**FAST**

**- +**

**TONE**

**NAR**

**CLAR**

**MCK**

**CLEAR**

**SKIP**

88.888.8

MHz

kHz

88

CH

These three indicators appear when the respective functions are active: split transceiver (page 21), GENeral coverage (100-kHz) **DOWN/UP** stepping (page 13), and dial or panel lock (page 15).

One of these four indicators shows the current VFO/memory state selected by the buttons to the right of the display, or when returning a memory (**M TUNE**).

This is the current operating frequency, with decimals at the MHz and kHz positions. The rightmost large digit is 100's of Hz. The displayed frequency changes when you transmit with either clarifier offset or split transceiver enabled.

These two small digits display the memory number when operating on a memory. For VFO operation, you can choose one of two functions: last-selected memory number (default), or the 10-Hz digit of the operating frequency (one digit only). Hold the **UP** button while switching the transceiver on to toggle these choices.

(Memory scan skip) This indicator appears when displaying a memory that has been selected to be skipped during memory scanning (page 25).

# General Description

The FT-890 is a high-performance transceiver providing up to 100 watts transmitter power output on all HF amateur radio bands in CW, SSB and FM modes, and up to 25 watts carrier in AM mode. The receiver tunes all frequencies between 100 kHz and 30 MHz in 10-Hz steps.

Modular circuit design employs surface-mount components on composite epoxy boards for high reliability and serviceability. Two direct digital synthesizers (DDSs) and a magnetic rotary encoder provide silent, silky-smooth tuning, pure local signals and very fast t/r changeover important for QSK CW. Frequency accuracy and stability are assured by driving both DDSs from a single master oscillator, and the optional TCXO-3 temperature-compensated crystal oscillator is available for enhanced  $\pm 2$ -ppm stability from  $-10$  to  $+50$  °C.

The low-noise, high-performance receiver front end uses a parallel pair of high-IDSS FETs in a constant-gain, grounded gate RF amplifier, feeding an active double-balanced quad FET ring mixer. The RF amplifier can be bypassed for direct feed to the mixer (by the IPO button), and a 12-dB attenuator can be inserted for clear copy of even very strong signals.

Interference rejection is facilitated by the unique "up-down-up" conversion scheme, which provides both IF shift and an IF notch filter. The optional YF-101 crystal filter can be installed to provide enhanced SSB and AM-narrow skirt selectivity.

Four microprocessors in the FT-890 are programmed to provide the simplest possible control interface for the operator. Two independent (A/B) VFOs for each band (20 total) hold their own frequencies and modes, as well as clarifier offsets and repeater shifts, when used. Thirty-two memories store all of this data for both VFOs, giving a total of 84 independent sets of frequency, mode and other selections. Of course all memories can be freely tuned and scanned, but two special memories also let you limit the tuning/scanning range between their stored frequencies.

Other valuable features include an effective noise blanker, all-mode squelch, 4-function multimeter, and an AF speech compressor with adjustable IF passband-shift, which lets you tailor SSB and AM transmitter audio to your own voice characteristics. Special features for CW include a built-in iambic memory keyer with dot-dash memory and a choice of 500- or 250-Hz narrow IF crystal filters.

For serious voice contesting, the same DVS-2 digital voice recorder option introduced with the FT-1000 can also be used with the FT-890, providing continuous-loop receiver recording and pushbutton transmission of multiple voice messages to help keep you at your peak QSO-rate throughout the contest.

The FT-890 weighs under 6 kg, and with its top-panel heatsink, runs cool all the time. An internal thermally switched fan allows full transmitter output without any rear panel protrusions, giving easy access to rear panel connectors and controls. A choice of automatic antenna tuners is available for the FT-890, each with its own microprocessor and 31 memories which automatically store most recent antenna matching settings for nearly instant recall while changing operating frequency. The ATU-2 can be mounted right inside the transceiver, or the FC-800 can be installed remotely at the antenna feedpoint. Each antenna tuner is controlled from the front panel of the FT-890.

Other accessories include the FP-800 AC Power Supply with Loudspeaker; the SP-6 External Loudspeaker with audio filters and optional LL-5 Phone Patch; the MMB-20 Mobile Mounting Bracket; the YH-77ST Headset; and the MD-1C8 Desktop and MH-1B8 Hand Microphones.

Before connecting the power cord, you should read the *Installation* section carefully, heeding the warnings in that section to avoid damage to the set. After installation, please take time to work through the *Operation* chapter, referring to the fold-out panel diagrams at the back of the manual as necessary for details. This manual is intended to be read while sitting in front of the FT-890, so you can try out each control and feature as they are described.

# Specifications

## General

**Receiving frequency range:** 100 kHz ~ 30 MHz

**Transmitting frequency ranges:**

- 160-m band, 1.8 to 2.0 MHz
- 80-m band, 3.5 to 4.0 MHz
- 40-m band, 7.0 to 7.5 MHz
- 30-m band, 10.1 to 10.5 MHz
- 20-m band, 14.0 to 14.5 MHz
- 17-m band, 18.0 to 18.5 MHz
- 15-m band, 21.0 to 21.5 MHz
- 12-m band, 24.5 to 25.0 MHz
- 10-m band, 28.0 to 29.7 MHz

**Frequency stability:**  $< \pm 10$  ppm, or  
 $< \pm 2$  ppm from  $-10$  to  $+50$  °C w/TCXO-3 option

**Emission modes:** LSB/USB (J3E), CW (A1A),  
AM (A3E), FM (F3E)

**Basic frequency steps:** 10 Hz for CW and SSB;  
100 Hz for AM and FM

**Antenna impedance:** 50Ω nominal without ATU  
16.5 to 150Ω with ATU (unbalanced)

**Supply voltage:**  
13.5-V DC  $\pm 10\%$ , negative ground

**Power consumption (approx.):**  
1.5 A receive (no signal)  
20 A transmit (100 watts)

**Dimensions (WHD):** 238 × 93 × 243 mm

**Weight (approx.):** 5.6 kg (12.3 lbs)

## Transmitter

**Power output:**  
adjustable up to 100 watts (25 watts AM carrier)

**Duty cycle:** 100% @ 100 watts PEP SSB

**Modulation types:**  
SSB: Balanced, filtered carrier  
AM: Low-level (early stage)  
FM: Variable reactance

**Maximum FM deviation:**  $\pm 2.5$  kHz

**Harmonic radiation:**  $> 50$  dB below peak output

**Spurious radiation:**  $> 40$  dB below peak output

**SSB carrier suppression:**  
 $> 40$  dB below peak output

**Undesired sideband suppression:**  
at least 50 dB below peak output

**Audio response (SSB):**  
not more than  $-6$  dB from 400 to 2600 Hz

**3rd-Order IMD:**  $-31$  dB typ. @ 100 W PEP, 14.2 MHz

**Microphone impedance:** 500 to 600 Ω

## Receiver

**Circuit type:** dual-conversion superheterodyne

**Intermediate frequencies:**  
70.455 and 455 kHz, 8.215-MHz Notch IF

**Sensitivity:**  
(for 10 dB S/N, 0 dBμ = 1 μV)

Frequency ⇒ Mode (BW) ↓	150 ~ 250 kHz (IPO on)	250 ~ 500 kHz (IPO off)	0.5 ~ 1.8 MHz (IPO off)	1.8 ~ 30 MHz (IPO off)
SSB, CW (2.4 kHz)	$< 5$ μV	$< 2$ μV	$< 1$ μV	$< 0.25$ μV
AM (6 kHz BW, 400-Hz, 30% mod)	$< 40$ μV	$< 16$ μV	$< 8$ μV	$< 1$ μV
29-MHz FM (for 12 dB SINAD)	—	—	—	$< 0.5$ μV

**Selectivity ( $-6/-60$  dB):**

Modes	Minimum $-6$ dB BW	Maximum $-60$ dB BW
SSB, CW wide, AM narrow (without options)	2.2 kHz	4.2 kHz
SSB, CW wide, AM narrow w/YF-101 option	2.4 kHz	4.2 kHz
CW narrow with YF-100 option	500 Hz	1.8 kHz
CW narrow with XF-455K-251-01 option	250 Hz	700 Hz
AM (wide)	6 kHz	18 kHz

**Squelch sensitivity:**

1.8 ~ 30 MHz (CW, SSB, AM):  $< 2.0$  μV  
28 ~ 30 MHz (FM):  $< 0.32$  μV

**IF rejection (1.8 ~ 30 MHz):** 70 dB or better

**Image rejection (1.8 ~ 30 MHz):** 70 dB or better

**IF Shift range:**  $\pm 1.2$  kHz

**IF Notch filter attenuation:** 30 dB or better

**Clarifier tuning range/steps:**  $\pm 9.99$  kHz/10 Hz

**Maximum audio power output:**  
at least 1.5 watts into 4 Ω with  $< 10\%$  THD

**Audio output impedance:** 4 to 8 Ω

## Automatic Antenna Tuner Options

**Impedance range:** 16.7 ~ 150Ω (unbalanced)

**Frequency range:** see Transmitting ranges, above

**Min. auto-tune & Max. power range:** 8 ~ 120 watts

**SWR when matched:** less than 1.4:1

**Matching time:** within 30 seconds

*Specifications are subject to change, in the interest of technical improvement, without notice or obligation.*



# Accessories & Options

## Supplied Accessories

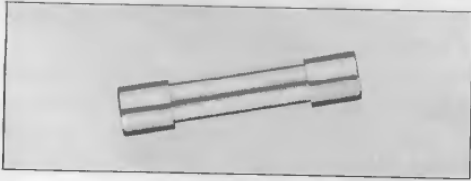

20-A Fuse (1 pc, #Q0000009)

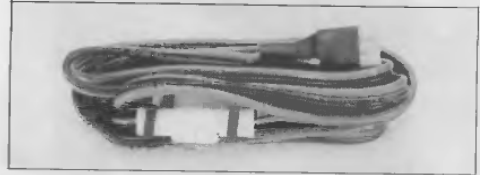

Fused DC Cable (1 pc, #T9018320)



3-ct Plug for KEY jack (1 pc, #P0090008)



2-ct Phono Plugs (2 pcs, #P0090544)



2-ct Plug for EXT SPKR jack (1 pc, #P0090034)



3-ct Plug for DATA IN/OUT jack (1 pc, #P0090726)

## Options

### ATU-2 & FC-800

#### Automatic Antenna Tuners

The ATU-2 (internal) and FC-800 (external remote) antenna tuners match impedances of up to about 3:1 with the transmitter. Operation is controlled from the front panel. The FC-800 plugs into the rear panel, and can be mounted at the antenna feedpoint to avoid feedline losses.

#### TCXO-3 Master Reference Oscillator

For special applications and environments where extra frequency stability is essential, the TCXO-3 temperature-compensated crystal oscillator is a 2-ppm (from -10 to +50°C) replacement for the reference oscillator.

#### SP-6 Loudspeaker with Audio Filters and LL-5 Phone Patch Option

Selectable audio high- and lowpass filters with a large loudspeaker complement the audio characteristics of the FT-890 with your choice of 12 different audio filtering combinations. Two input terminals are provided for multiple transceivers,





with a front panel switch to select between them. A phone jack is provided on the front panel to take advantage of the audio filters with headphones.

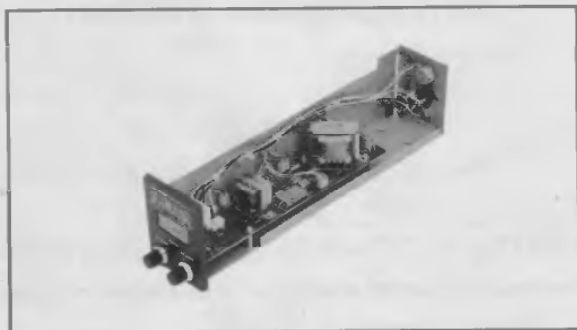

With the optional LL-5 Phone Patch Unit installed in the SP-6, the FT-890 can be patched to the public telephone network. The LL-5 includes a hybrid transformer circuit to assure proper impedance matches, and gain controls and level meter to set proper audio levels on the telephone line.



### YH-77ST Lightweight Headphones

Dual samarium-cobalt transducers with sensitivity of 103 dB/mW (2 dB @1 kHz, 35Ω) provide the perfect match for the FT-890, taking full advantage of the spectacular audio performance.



### DVS-2 Digital Voice System

Serving as either a continuous receiver recorder for instant pushbutton playback, or microphone audio recorder for multiple on air playback, the DVS-2 applies the advantages of random-access solid-state digital memory to serious communications. All data is stored electronically, with no moving parts except your finger and a pushbutton. More information is on page 30.



### FIF-232C CAT System Interface

To control the FT-890 from an RS-232C serial port of an external personal computer, use the FIF-232C to convert the TTL levels required by the transceiver to the RS-232C levels required by the serial port. A cable is included for connection between the transceiver and the FIF-232C (the cable to the computer must be provided separately). The FIF-232C includes its own AC power supply.



### IF Crystal Filter Options

For extra CW receiver selectivity, the 500-Hz YF-100 or 250-Hz XF-455K-251-01 8-pole crystal filter may be installed in the 455-kHz 2nd IF of the FT-890.

Also, for enhanced SSB and AM narrow receiver fidelity and ultimate attenuation, the YF-101 8-pole, 2.6-kHz crystal filter may be installed in place of the standard ceramic filter.

Microphones

Matching the electrical and cosmetic features of the FT-890, the MH-1B8 Hand Mic and MD-1C8 Desktop Mic have 600-Ω impedance, and include up/down scanning buttons and a large PTT switch with latch. The MH-1B8 also has a 2-position transmit audio characteristic selector, while the MD-1C8 has a 3-position selector. Typical audio characteristic plots with the different switch settings are indicated in the graphs below.

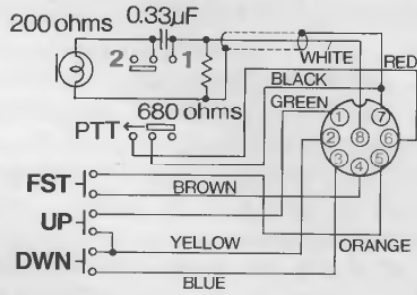

MH-1B8

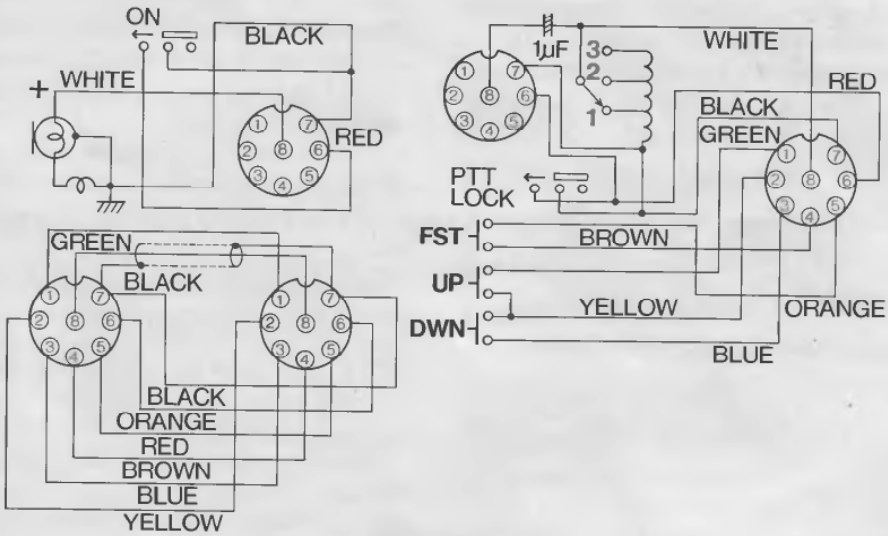
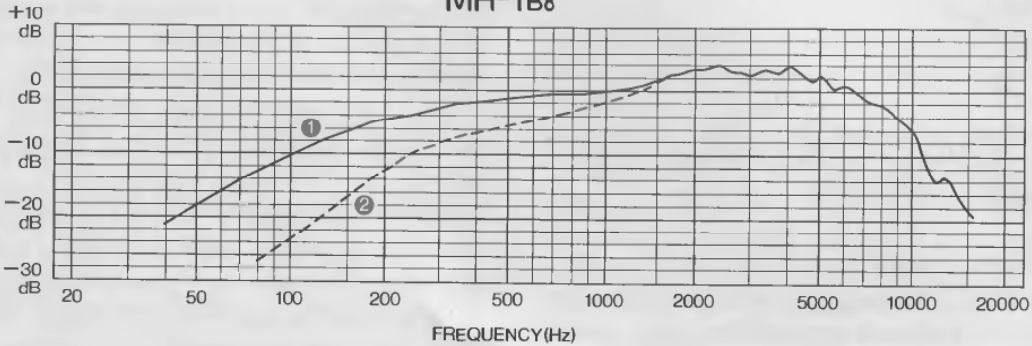

MD-1C8

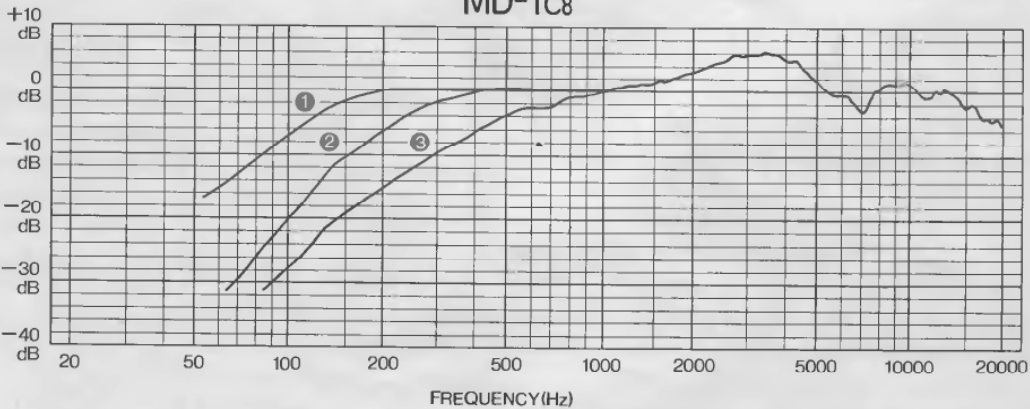

# Station Installation

## Preliminary Inspection

Inspect the transceiver thoroughly immediately upon opening the packing carton. Confirm that all controls and switches work freely, and inspect the cabinet for any damage. Make sure the accessory fuses and plugs pictured on page 3 are included. If any damage is found document it completely, and contact the shipping company (or dealer, if you purchased it over the counter) right away. Save the packing materials in case you need to return the set for service.

If you purchased optional internal accessories separately, install them as described in *Installing Internal Accessories* (page 36). This chapter describes base station installation first, followed by mobile installation and then interconnections with external accessories.

## AC Power Supply

The FT-890 is designed for operation from 13.5-V DC, negative ground. For base station installations, we recommend the matching Yaesu FP-800 AC power supply which was specifically designed for this purpose, and which includes a large loudspeaker for the transceiver and its own cooling fan. You can use another DC source capable of providing 20 amperes at 13.5-V DC with

### Caution!

*Permanent damage can result if improper supply voltage is applied to the transceiver. Your warranty does not cover damage caused by application of AC, reversed polarity DC, or DC outside of the specified range of 13.5 V  $\pm$  10%.*

the supplied DC cable assembly, but you must be extremely careful to avoid reversed polarity connection. See the Caution box above.

If you are connecting the FP-800 with the FT-890, before connecting power, check the label on the rear of the FP-800 which indicates the AC mains voltage range for which the supply is currently set. If your AC mains voltage is outside of this range, the transformer taps inside the power supply must be rewired, and the fuse in the FP-800 must be changed. This involves some soldering of the AC mains input (see below), so you should ask your dealer for assistance if you are not experienced with this sort of work. *Incorrect connections could cause serious damage not covered by the warranty.*

## Changing the AC Voltage Range of the FP-800 Power Supply

- Disconnect the AC cable from the rear of the FP-800, and the DC cable from the FT-890.
- Remove the 8 screws affixing the top cover.
- Unsolder the wires from the transformer, and resolder for the required voltage as indicated below.
- Replace the fuse in the rear panel holder with a fast-blow, 8-A fuse (for 100 ~ 117-V AC) or 4-A (for 200 ~ 234-V AC).
- Check your work carefully, then replace the top cover and its 8 screws. Change the voltage marking on the FP-800 rear panel label, and replace the AC cord, if necessary.

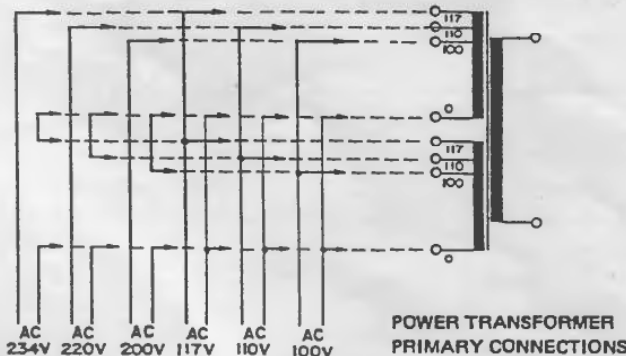

### Important!

*If you change the AC voltage range you must change the fuse in the rear panel holder. Do not use a slow-blow fuse. Also make sure to change the voltage marking on the label on the rear panel to match the new voltage setting.*

In any case, make sure the power supply is set correctly before connecting power. If you have any doubts about the procedure, ask your dealer for help.

You should also make sure the fuse in the FP-800 rear panel fuse holder is correct for your mains voltage:

AC Mains Voltage	Fuse Capacity
100 ~ 117	8 A
200 ~ 234	4 A

After making certain the AC voltage for which the power supply is set matches your mains voltage, and that the correct fuse is installed in the fuse holder, connect the DC cable from the power supply to the jack on the rear panel. Don't plug the power supply cord into the wall until all other transceiver interconnections have been made.

### Transceiver Location

To assure long life of the components, make sure to provide adequate ventilation around the cabinet. The cooling system of the FT-890 must be free to draw cool air in at the bottom rear of the transceiver, and to expel warm air out of the upper rear panel. Do not place the transceiver on top of another heat-generating device such as a linear amplifier, and do not place equipment, books or papers on top of the transceiver. Place the transceiver on a hard, flat surface. Avoid heating vents and window locations that could expose the transceiver to excessive direct sunlight, especially in hot climates.

### Grounding

For protection from shock and proper performance, connect the **GND** terminal on the rear panel to a good earth ground, using a heavy braided cable of the shortest length possible. All other station equipment should be connected to the same grounding cable, as close together as practical. If you use a computer with or near the FT-890, you may need to experiment with grounding of both the transceiver and the computer to suppress computer noise in the receiver.

### Adjusting the Front Panel Angle

If your installation places the FT-890 much below eye level, you may want to prop up the front. A wire bail on the bottom of the FT-890 can be folded down for this purpose.

### Antenna Considerations

Any antenna connected to the FT-890 should have a coaxial feedline with 50- $\Omega$  impedance, and include a well-grounded lightning arrester. The internal ATU-2 and external FC-800 antenna tuners are capable of matching antennas with an SWR of up to 3:1 or more on the amateur bands to the transmitter. Nevertheless, optimum performance for both reception and transmission will generally result with an antenna designed to provide a 50- $\Omega$  unbalanced resistive load at the operating frequency. An antenna that is not resonant at the operating frequency may present too high an SWR for proper matching with the antenna tuner, in which case the antenna should be readjusted, or a wide-range manual antenna tuner should be used. If the tuner is unable to bring the SWR down to an acceptable level, attempting to transmit will result in an automatic reduction in power output and increased losses in the feedline. Operation under such conditions can waste power and cause TVI, RFI and RF feedback: it is better to install another antenna designed for that band. Also, if your antenna has a balanced feedpoint and you use a balanced feedline, install a balun transformer between the feedline and the transceiver's antenna jack.

### Mobile Power Connection

A fused (20-A) DC power cable for mobile installation is supplied with the transceiver. Please note the *Caution* at the beginning of this chapter before connecting power. Plan to connect the DC cable directly to the vehicle battery, rather than to the ignition or accessory circuitry. Route the cable as far away from ignition cables as possible, and then cut off any extra cable (from the battery end) to minimize voltage drop losses. If the cable is not long enough, use #12 AWG stranded, insulated wire to extend it, but no more than is necessary. Use the following procedure to connect the cable:

- Before connecting the cable, measure the voltage across the battery terminals with the engine running fast enough to show a charge. If above 15 volts, the automobile voltage regulator must be adjusted to reduce the charging voltage before proceeding.
- With the radio end of the cable unconnected, connect the RED cable lead to the POSITIVE battery terminal, and the BLACK lead to the NEGATIVE terminal. Make sure the battery terminal connections are tight, and remember

to check them periodically for signs of loosening or corrosion.

- Make sure the **POWER** switch on the transceiver is off, and plug the DC cable into the 6-pin molex jack on the rear panel.

### Caution!

*In mobile installations, check to ensure that the transceiver **POWER** switch is off whenever starting or stopping the engine, to avoid damage from switching transients.*

### Mobile Mounting

The optional MMB-20 Mobile Mounting Bracket allows quick insertion and removal of the transceiver from the vehicle. Complete instructions are provided with the bracket, which can be mounted above or below the transceiver.

MMB-20 Mobile Mounting Bracket

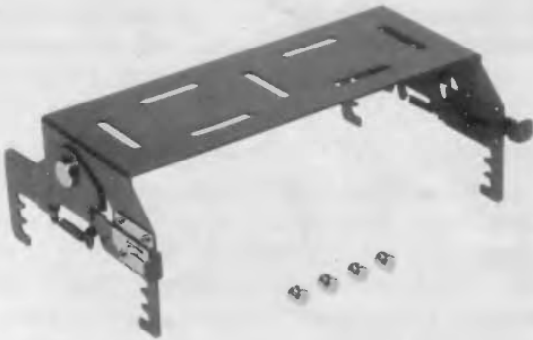

### Mobile Antenna Installation

Please review the Antenna Considerations on the previous page, as they apply equally to base and mobile antennas. The FC-800 or FC-1000 Remote Antenna Tuners are particularly desirable in a mobile station, where the short antenna elements have very narrow bandwidth. Make sure that the shield of the antenna coax is firmly grounded to the car body at the antenna feed-point if using a base-loaded vertical.

### Interconnection of Accessories

The diagrams on the following pages show interconnections of external accessories. If you have any questions on these accessories or connecting devices not shown, contact your dealer for advice.

### Memory Backup

The lithium memory **BACKUP** switch inside the hole at the front center of the bottom panel is turned on at the factory, allowing VFO and memory data to be retained while power is off. Backup current is miniscule, so it is not necessary to turn the **BACKUP** switch off unless the transceiver is to be stored for a long time.





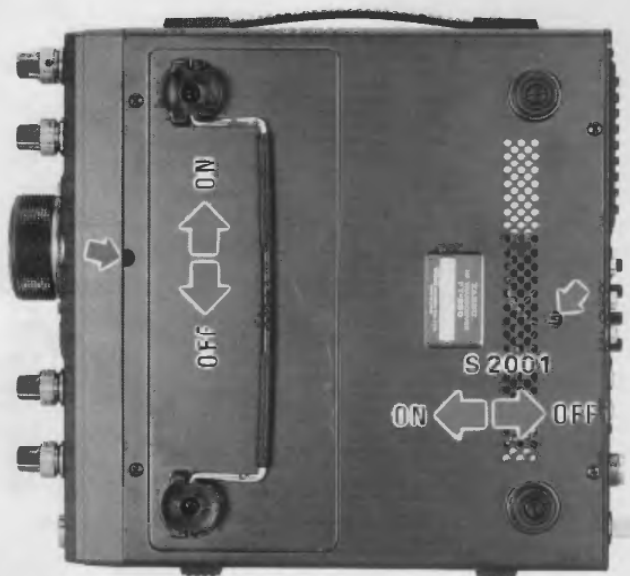

After about five years the transceiver may fail to retain memories (although operation will be otherwise unaffected), and the lithium battery should be replaced. Ask your dealer for replacement of the battery, or for instructions on how to do so yourself.

Downloaded by  [RadioAmateur.EU](http://RadioAmateur.EU)

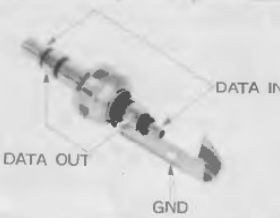
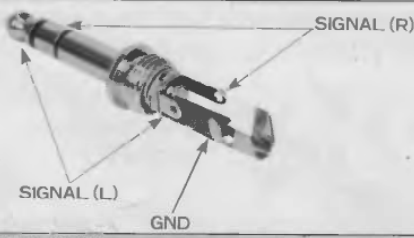
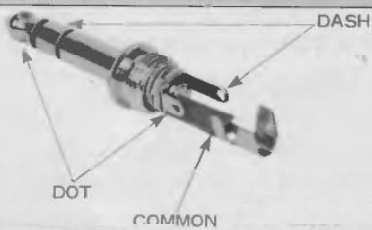
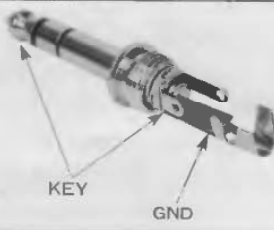
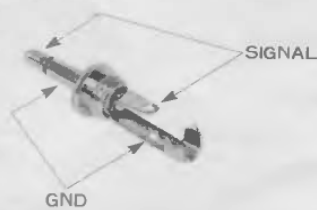

Switch Locations in Bottom Cover

Connector Pinouts

<p><b>BAND DATA</b></p>  <ul style="list-style-type: none"> <li>1 +13V</li> <li>2 TX GND</li> <li>3 GND</li> <li>4 BAND DATA A</li> <li>5 BAND DATA B</li> <li>6 BAND DATA C</li> <li>7 BAND DATA D</li> <li>8 LINEAR</li> </ul>	<p><b>TUNER</b></p>  <ul style="list-style-type: none"> <li>1 GND</li> <li>2 +13V</li> <li>3 DATA</li> <li>4 GND</li> <li>5 GND BY FC-800</li> </ul>
<p><b>CAT</b></p>  <ul style="list-style-type: none"> <li>1 GND</li> <li>2 SERIAL OUT</li> <li>3 SERIAL IN</li> <li>4 PTT</li> <li>5 S/PO</li> <li>6 NC</li> </ul>	<p><b>DVS-2</b></p>  <ul style="list-style-type: none"> <li>1 VOICE IN</li> <li>2 VOICE OUT</li> <li>3 PTT</li> <li>4 +9V</li> <li>5 CNTL 1</li> <li>6 CNTL 2</li> <li>7 GND</li> </ul>
<p><b>DATA IN/OUT</b></p> 	<p><b>PHONES</b></p> 
<p><b>KEYER PADDLE</b></p> 	<p><b>STRAIGHT KEY</b></p> 
<p><b>EXT SPKR</b></p> 	<p><b>RCA PLUG</b></p> 

# Connecting External Accessories

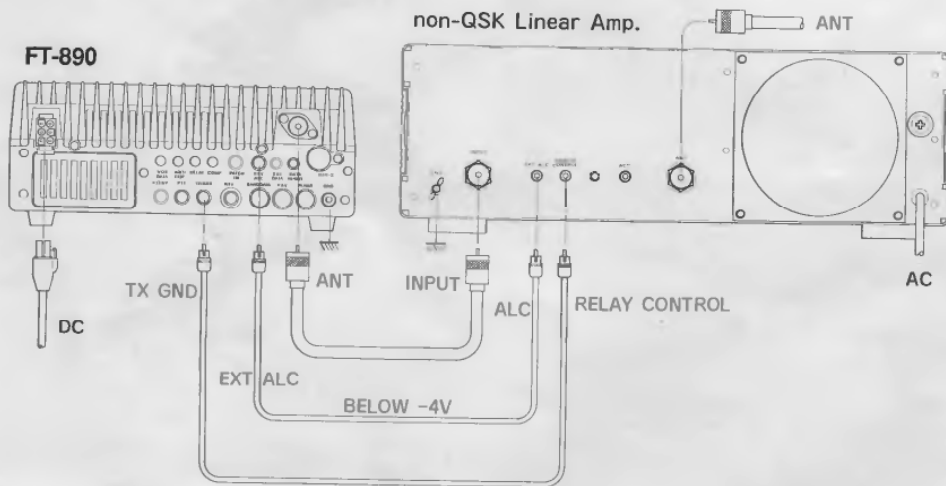
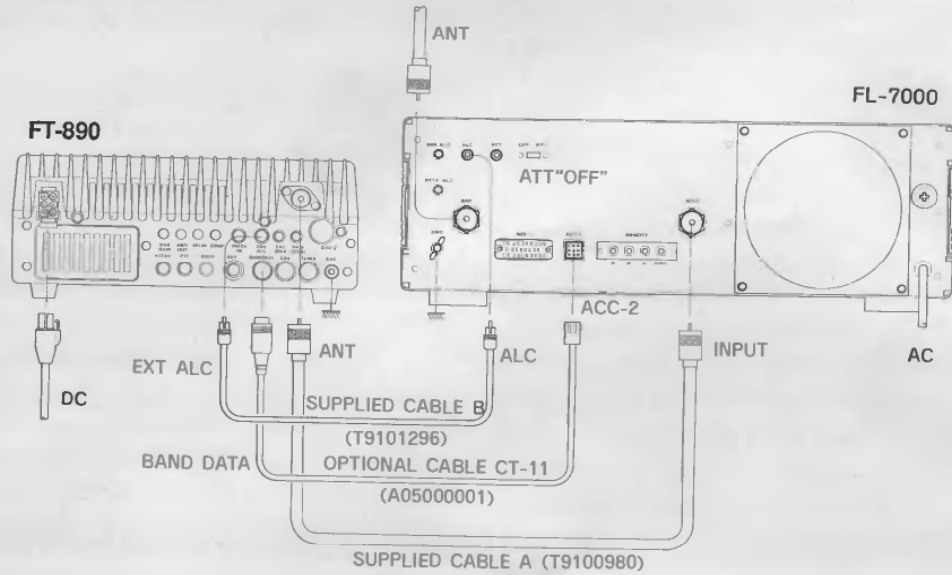

Downloaded by  RadioAmateur.EU



## Connecting a Linear Amplifier

For all linear amplifiers, connect the ALC output from the linear to the **EXT ALC** jack on the rear of the transceiver. After making the RF and t/r switching connections described below, you will probably need to adjust the ALC output level of the linear so that it is not overdriven by the FT-890. Your linear's manual should describe how to do this.

If using an FL-7000 with the FT-890, use optional cable CT-11 to provide automatic band selection for the linear, as well as QSK t/r switching control. If using another QSK linear, and if it can be switched with less than 100 mA of DC voltage below 15 V, you can connect the the t/r switch line for the linear to pin 2 of the **BAND DATA** jack, and the linear's exciter-enable output to pin 8 of the **BAND DATA** jack. This line must be held high (+5 to 15 V) to inhibit transmission until the linear is ready for excitation by the FT-890. If your QSK linear requires more than 100 mA or uses more than 15 V for t/r relay switching, you will have to provide a suitable external interface transistor, controlled by pin 2.

The FT-890 provides the **TX GND** jack on the rear panel, connected to an internal relay, for non-QSK t/r switching of linear amplifiers that use AC voltage, or DC voltage above 15 V, or require more than 100 mA for t/r switching. This relay is disabled at the factory to avoid the click sound when the transceiver is used alone or with a QSK linear. To enable the relay for non-QSK linears that exceed the above t/r switching requirements, you will need move switch S2001, located in the large hole near the rear center of the bottom cover, to its forward position (see the photo on page 8). Turn the FT-890 on its side or upside down and use a thin, sharp object to move the switch. Then connect the center contact of the **TX GND** jack to the positive line to your linear, and the outer contact to the negative line or the linear's chassis ground (if there is no separate negative line).

With the relay enabled, the FT-890 can support *non-QSK* linear t/r switching voltage up to 125 VAC @ 200 mA, or DC voltage up to 220 V @ 300 mA, or closed-circuit current up to 2 A with DC voltage up to 30 V. Use the **TX GND** jack after setting S2001 to the forward (on) position. *Do not attempt QSK operation with a linear if its switching requires the relay enabled.*

### Caution!

*The FT-890 is designed for use with the FL-7000 when QSK operation with a linear amplifier is required, and with the internal t/r relay enabled for non-QSK operation with all other amplifiers. Using pins 2 and 8 of the BAND DATA jack for other amplifiers will not work unless the control line signals are carefully matched, and damage may result otherwise. Your warranty does not cover damage resulting from improper connections to this jack, so if you are unsure, use the TX GND jack and operate non-QSK only.*

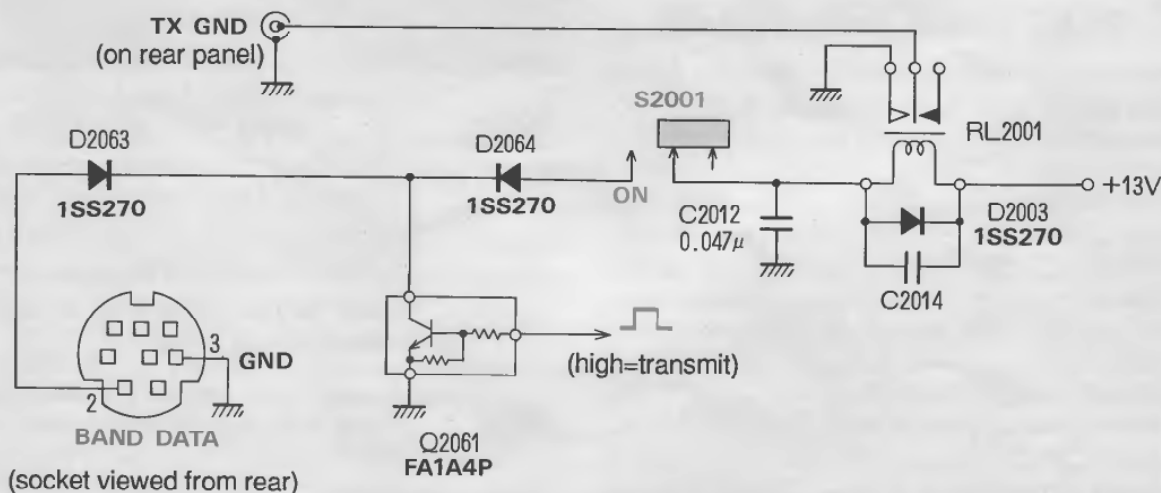

Linear Amp T/R Switching in the FT-890

## Power-Up Customization & Button Combination Settings

By pressing and holding certain buttons while switching on the FT-890, you can make many settings to customize features to your particular requirements, and perform several troubleshooting functions. Some important settings can also be selected by holding the **FAST** button while pressing certain other buttons. These are described in the tables below. Default settings are in *italics*.

Power-Up Functions	Hold this button & turn on	Comments
Panel Button Beeper <i>Enable/Disable</i>	<b>NOTCH</b>	Press a button to see if the beeper is enabled.
Display <i>BFO Offset</i> or Carrier Frequency in CW mode	<b>BAND/MEM DOWN</b>	BFO Offset adds 700 Hz to displayed CW frequency. Affects display only.
Display 10-Hz Frequency Digit at right end of display, or <i>Last Memory</i> (toggle)	<b>BAND/MEM UP</b>	Affects display only.
Make <b>FAST</b> Button press-on/press-off, or <i>active-only-while-pressed</i>	<b>FAST</b>	<b>FAST</b> is displayed when active.
Adjust Repeater Shift (0 to 200 kHz, <i>100 kHz default</i> ). Press <b>RPT/T</b> again after setting.	<b>RPT/T</b>	Shift is displayed. Use tuning knob or <b>DOWN/UP</b> to change in 1-kHz steps.
Cause Clarifier to activate Memory Tune mode when operating on a memory ( <i>enable/disable</i> )	<b>NB</b>	Disable to allow clarifier adjustment without automatic switching from Mem to Memory Tune.
Clear All Memories and return settings to factory defaults	<b>HAM/GEN + CLAR</b>	VFOs and Memory 1 default to 7.000 MHz LSB.
Scan Resume Mode: Always after 5-sec pause, or <i>only after squelch closes</i> .	<b>VFO/M</b>	There is always a pause after squelch closes before scanning resumes.
Select Lock Mode: <i>Tuning Knob Only</i> , or Knob & Buttons	<b>LOCK</b>	" <b>LOCK</b> " blinks when buttons are locked. <b>MOX</b> and <b>POWER</b> cannot be locked.
Test all Display Segments, and Check Firmware Version	<b>A/B + A=B</b>	Display tests performed for 15 seconds, followed by ROM version number for 2 seconds, and return to normal.

FAST Button Combinations	Hold FAST button and press...	Comments
Set Beeper Audio Frequency (220 to 7000 Hz, <i>800 default</i> ). Press <b>NOTCH</b> again when done.	<b>NOTCH</b>	Repeating double beep sounds and beep frequency displayed in Hz while adjusting.
Display Brightness	Turn <b>CLAR</b>	Choose 1 of 8 levels.
Knob Tuning Rate Selection: toggle <i>5 &amp; 50</i> or <i>10 &amp; 100 kHz per turn</i>	<b>SWR</b>	Affects Tuning Knob rate only: Steps are unaffected.
Speech Processor IF Offset Adjust ( $\pm 300$ Hz). Must be in an SSB or AM mode. Press <b>PROC</b> again when done.	<b>PROC</b>	Listen to your signal in an external receiver while adjusting.
Display/Select CTCSS Tone Frequency (from standard tones, <i>default 88.5 Hz</i> ). Press <b>RPT/T</b> again when done.	<b>RPT/T</b>	Displays tone frequency in Hz. Use tuning knob or <b>DOWN/UP</b> buttons to select.
Toggle Current Memory to be skipped when Memory Scanning ( <i>skip/no-skip</i> )	<b>VFO/M</b>	Affects only memory scanning. " <b>SKIP</b> " displayed when activated.

# Operation

## Getting Started Tutorial

While reading this chapter, refer to the fold-out photos of the panels for the locations and functions of the controls and jacks.

Before plugging in the transceiver the first time, make sure your supply voltage is correct, and that your ground and antenna are connected as described in the *Installation* chapter. Then preset the following controls:

**POWER, MOX, VOX & switches:** off (■);  
**MIC, RF PWR, SQL and NB:** all ccw (minimum);  
**AF:** 10 o'clock;  
**RF:** fully clockwise;  
**SHIFT and NOTCH:** 12 o'clock.

Connect your microphone and/or CW key or paddles, and then press the **POWER** switch on. The meter and display should light up. If the display is too bright or dim, hold the **FAST** button below the tuning knob while turning the **CLAR** control to adjust display brightness.

At the left side of the panel, if the green LEDs in any of the **PROC, AGC-F, IPO, ATT & RPT/T** buttons are on, press to turn them off.

Take a moment to study the display. You should see "VFO-A" or "VFO-B" at the left, with the operating frequency in large digits in the center (if you don't see a VFO indicator, press the **VFO/M** button near the top right). At the right side of the display is either a small 2-digit memory channel number ("01" by default), or a single-digit indicating the 10's-of-Hz of the operating frequency.



Use the **BAND/MEM DOWN** and **UP** buttons (to the right of the tuning knob) to select a band for which your antenna is designed. These buttons have several different functions:

- By default (the *ham stepping* mode), when receiving on a VFO, these step from one ham band to another. Changing bands stores the current frequency automatically, so that **DOWN** and **UP** always return you to the frequency last used on each band (if it is inside the 500-kHz range of the ham band). The 10-meter band has two 1-MHz ham bands.
- If the **HAM/GEN** button has been pressed (to activate *GENeral coverage tuning mode*),

"GEN" appears to the left of the frequency on the display, and the **DOWN** and **UP** buttons step in 100-kHz increments (or 1-MHz if **FAST** tuning is activated as described below).

**Example:** say you're tuned to 7.000 MHz, and want to change to 21.200 MHz.

- First check to see if "GEN" appears on the left side of the display, and if it does, press the **HAM/GEN** button.
- Then press the **UP** button 4 times to change to the last-used frequency on the 15-meter band.
- Now you can use the tuning knob to tune to 21.200. However, if the current frequency is more than 100 kHz away, you can save some cranking: press **HAM/GEN** again so that "GEN" appears, and press the **DOWN** and **UP** buttons, as needed, to get within 100 kHz. Then use the tuning knob. When you want to change bands again, remember to press **HAM/GEN** so that "GEN" disappears.

Press the mode button (to the left of the tuning knob) corresponding to the mode you wish to operate — for now, we suggest an SSB mode: **USB** if you have selected a band above 10 MHz, or **LSB** otherwise. LEDs in the mode buttons show the selected mode.

Adjust the **AF** control for comfortable volume on signals or noise in the loudspeaker or headphones. Tune around the band a bit with the tuning knob to get the feel of it (if you want to adjust the torque, see page 22). For faster ( $\times 10$ ) tuning steps, press the **FAST** button at the lower left side of the knob, to enable the "FAST" indicator above the MHz digits on the display.

Fast tuning normally requires holding this button while tuning, but if you hold it while switching the FT-890 on, the button becomes a toggle (press on/press off). The table below lists all available tuning steps in each mode. If your

### Tuning & Scanning Steps

Control ↓	Mode ⇒	LSB, USB, CW	AM & FM
Tuning knob, Mic Up/Dwn Keys	Normal	10 Hz	100 Hz
	w/FAST button	100 Hz	1 kHz
<b>DOWN/UP</b> Pushbuttons	Normal	100 kHz	100 kHz
	w/FAST button	1 MHz	1 MHz
One rev of tuning knob*	Normal	5 kHz	50 kHz
	w/FAST button	50 kHz	500 kHz

\* To double knob tuning rate, hold **FAST** and press **SWR**.

### Displaying the 10's-of-Hz Digit

The FT-890 defaults to display frequency only to 100-Hz resolution, so the actual 10-Hz tuning resolution is not visible. This means that when tuning with the microphone **UP** and **DWN** buttons in CW and SSB modes, the displayed frequency changes only once every 10 button presses. You can change the display to show the 10-Hz digit at the right (in place of the memory number), by holding the **BAND/MEM UP** button while switching the set on. Tuning steps are not affected.

microphone has **UP** and **DWN** buttons, you can use them to tune in 10- or 100-Hz steps. Also, the **FAST** button on the microphone duplicates the **FAST** button on the front panel.

### General Coverage Reception

You may have already noticed that you can tune outside one of the amateur bands (actually, outside the 500-kHz segment that includes each ham band) regardless of whether GEN or ham-stepping is selected for the **BAND/MEM DOWN** and **UP** buttons. However, the transmitter (and antenna tuner) are disabled on such frequencies. If you try to transmit, the **TX** LED still lights, but there is no RF power output.

Also, the ham band recall system ignores such frequencies. If you select a ham band and then tune outside the band, the non-ham frequency will be lost when you change bands. When you return to the original band you will find that it has reverted to the (ham-band) frequency it was on when that band was previously selected.

Don't let this worry you: any displayed frequency can always be stored in a memory (as described on page 23) so you can recall it quickly later. Once you become familiar with the memories, you will find this convenient: each memory can be tuned just like a pair of VFOs, and stored again without having to go through the VFOs.

Besides the above, general coverage reception provides all the features available on ham frequencies.

## Dealing with Interference

The FT-890 includes special features to suppress the many types of interference that may be encountered on the HF bands. Still, real world conditions are constantly changing, so optimum setting of the controls is somewhat of an art, requiring familiarity with the types of interference and the subtle effects of some controls. Therefore the following information should be considered only as general guidelines for typical situations, and a starting point for your own experimentation.

The controls are described in the order that you would usually make them after changing bands. An exception to this is if strong pulse noise is present, such as from the "Woodpecker", in which case you may need to activate the noise blanker (described on the next page) before making other adjustments.

### Front End Selections:

#### RF Amp (IPO) & Attenuation

A constant-gain, dual parallel FET RF amplifier in the FT-890 receiver front end provides high sensitivity to weak signals. This amplifier is active whenever the **IPO** button is *OFF*, and bypassed when it is on. Additionally, a 12-dB attenuator in front of the RF amplifier can be activated by the **ATT** button.

### Button Beeper Settings

As shipped from the factory, pressing a button on the front panel causes a beep to sound. The volume of the beep is independent of the receiver volume, and can be set by a trimpot accessible through a hole in the left side of the transceiver as described on page 20.

You can also toggle the beeper (to be enabled or disabled) by holding the **NOTCH** button near the lower left corner of the front panel while switching the transceiver on.

If you wish to change the pitch of the beeper, hold the **FAST** button (below left of the tuning knob) while pressing the **NOTCH** button. This causes the display to show the beeper frequency in Hz, while double beeps sound. Turning the **CLAR** knob adjusts the beep pitch. When done, press the **NOTCH** button again to return to normal operation.

When looking for weak signals on a quiet band you will want maximum sensitivity, so the **IPO** and **ATT** buttons should both be switched off. This situation is typical during quiet times on frequencies above 20 MHz, and when using a small antenna on other bands.

If you notice intermodulation from strong signals on other frequencies, turn on the **IPO** (Intercept Point Optimization) function to bypass the RF amplifier. Sensitivity is reduced slightly, but intermodulation immunity increases.

Even with the **IPO** function on, very strong signals can still overload the mixer. So if you still notice intermodulation, or if the signals you want to listen to are very strong, you can press the **ATT** button. This reduces the strength of all signals (and noise) by 12-dB (about 2 S-units), and can make reception more comfortable, important especially in long QSOs.

### RF Gain Setting

When tuned to a moderate-strength signal, if low-level background noise is present, try reducing the **RF** gain control from the fully clockwise position. This reduces the gain of the IF amplifiers and causes the minimum S-meter reading to move up the scale, often clearing up the background noise and putting the desired signal more "in the clear." But don't forget to return this control fully clockwise when you want to receive weak signals, or read low levels on the S-meter.

### AGC-F (Automatic Gain Control - Fast Recovery) Selection

When tuning around the band looking for signals, the **AGC-F** button is usually best kept on, so receiver gain recovers quickly after tuning past strong signals. Once you have a signal tuned in, unless it is very weak, you probably will find reception more comfortable with it off (slow AGC).

### Noise Blanker Setting

The noise blanker circuit in the FT-890 can blank both wide and narrow pulse noise, and can sometimes also reduce the level of static crashes from electrical storms. The **NB** button/LED activates the blanker, and remains lit while it is on. If you hear pulse noise, just press the **NB** button so that it lights, and turn the **NB** control clockwise just until the noise is blanked. If the blanker seems to distort a signal you're listening to, reduce the setting for optimum readability.

### IF Shift Adjustment

(not used in AM & FM modes)

Once you have tuned in a signal you are going to listen to for a while, if you hear interference from nearby frequencies, use the **SHIFT** control to suppress the interference. Turning the **SHIFT** control left or right from center shifts the center frequency lower or higher, as depicted here.

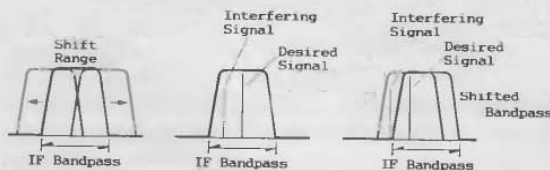

You will want to press the **LOCK** button beneath the tuning knob before adjusting the **SHIFT** control, as accidentally retuning would invalidate your setting (particularly in narrow-bandwidth CW). When ready to retune to a new frequency, press **LOCK** again to release it, and return the **SHIFT** control to its normal position (centered).

### AM & CW Narrow IF filters

Pressing the AM mode button once (when switching from another mode), selects 100-Hz tuning steps and the 6-kHz AM wide bandwidth. This gives the highest fidelity, and is best on strong AM signals (and particularly music). For weaker AM signals, or where adjacent channel interference is present, the narrower 2.4-kHz IF bandwidth offers a compromise between interference rejection and fidelity. This can be selected by pressing the AM mode button a second time (**NAR** appears at the top of the display).

For even better reception of AM signals under these conditions, you can switch to an SSB mode (whichever sideband gives the clearest reception). Along with the choice of the best sideband,

### Locking the Dial or Buttons

Normally, pressing the **LOCK** button disables only the tuning knob (it still turns, but does nothing). If you wish to have the **LOCK** button also disable the buttons (except **MOX** and **VOX**), turn the set off and then hold it while switching back on.

you gain several benefits of the **SHIFT** control. After selecting the best sideband (LSB or USB mode), you need to zero beat the carrier to avoid distortion: turn the **SHIFT** control all the way clockwise for LSB or counterclockwise for USB, fine tune until the signal is steady, then return the **SHIFT** control to center (or for best audio and interference suppression).

### YF-101 SSB Crystal Filter Option

The optional YF-101 crystal IF filter can be installed in place of the 2.4-kHz ceramic IF filter, to enhance SSB and AM narrow reception. While both filters have approximately the same shape factor and bandwidth, the crystal filter provides a flatter passband, giving receiver audio a more natural sound, and also deeper attenuation for better immunity to interference from nearby signals. Typical plots of the two filters are superimposed below for comparison. Ask your dealer for the YF-101 option if you don't have it. Installation is described beginning on page 36.

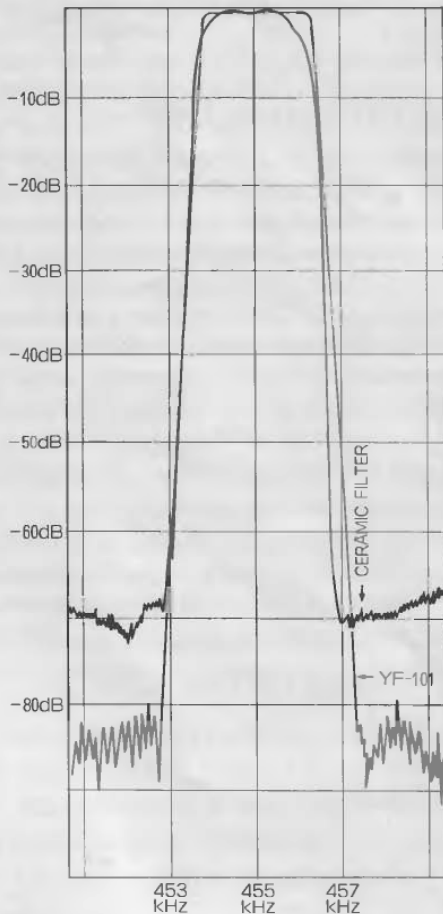

### 10-Hz Steps in AM & FM Modes

When changing modes from SSB or CW to AM or FM, operation initially remains on the same frequency, even if it is not a multiple of 100 Hz. As soon as you attempt to tune, the operating frequency jumps up or down to the nearest whole 100-Hz step. However, the clarifier uses 10-Hz steps in all modes, so if you need 10-Hz resolution in AM or FM mode, activate the clarifier (see page 21).

Pressing the CW mode button once when switching from another mode selects the 2.4-kHz IF bandwidth also used for SSB. If you have either the 250-Hz or 500-Hz narrow IF filter installed, pressing the CW button again selects the narrow filter, and "NAR" appears at the top of the display. The 2.4-kHz bandwidth is often convenient to give "a wide view" when tuning around, but once you find a signal of interest and center it in the passband, the narrow selection is much better. The next section on transmission gives more details of CW operation.

### IF Notch Filter (not used in FM mode)

After tuning in a desired signal and adjusting the IF shift, if you hear heterodyne interference, activate the IF notch filter by pressing the **NOTCH** button/LED and adjusting the control with the same name to null the heterodyne. Note that if the interfering heterodyne is more than about 1.2 kHz away from the center of the passband, the notch filter may be unable to null it. Try switching the notch filter off and readjusting the **SHIFT** so that the heterodyne is outside the passband.

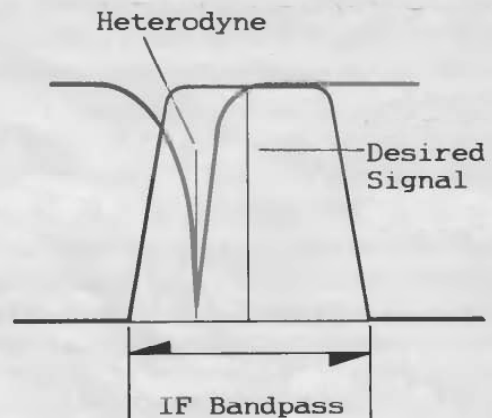

IF Notch Filter Adjustment

## Transmitting

The FT-890 can transmit within the 500-kHz segment of the HF amateur bands above 1.8 MHz, and from 28 to 30 MHz. When tuned between 1.5 and 1.8 MHz, the tuner will not function, and when tuned to any other (general coverage) frequency, the transmitter is disabled. Still, you should restrict your transmissions to those frequencies authorized by your license, and for which your antenna is designed.

Attempting to transmit out of band still causes the red **TX** LED to the right of the meter to light, but the transmitter will provide no output. The transmitter is also temporarily inhibited when stopping scanning (described later), as pressing the PTT switch while scanning just causes the scanner to stop.

When you transmit on an amateur band, the FT-890 senses reflected power at the antenna jack. If an impedance mismatch causes too much reflected power, the transmitter shuts down, and "**HI SWR**" appears near the upper left corner of the display. Although this should prevent damage to the transceiver, we still recommend that you not transmit without having a proper antenna connected to the antenna jack.

## Automatic Antenna Matching

The internal ATU-2 or external FC-800 automatic antenna tuner makes even first-time transmitter setup very simple. After using it once on a band, it recalls previous settings from memory (the tuner has 31 of its own) during reception, whenever you tune to the same part of the band again. When using the tuner the first time on an antenna, we recommend you set the **RF PWR** control to around the 9-o'clock position (or 12-o'clock above 24.5 MHz), to minimize possible interference to others and to minimize stress on the tuner, feedline and antenna (in case there is a high SWR). All you have to do beforehand is ensure your transmit frequency is clear of other signals. If you want to monitor the tuner's action, press the **SWR** button/LED so it lights.

If "**SPLIT**" is displayed to the left of the frequency, press the **SPLIT** button near the top right to disable split operation for now.

After making sure you are on a valid transmitting frequency, and that the channel is clear of other signals, press the **START** button near the upper right corner of the front panel. The green **TUNER** LED comes on, indicating the automatic tuner is activated, "**WAIT**" appears at the top left

### Important!

*If the red **HI SWR** LED lights at any time, the tuner is unable to match your antenna to the transmitter at the displayed frequency. You will have to tune to another frequency, or repair or replace your antenna or feedline.*

corner of the display, and the red **TX** LED at the left end of the display lights for one to about thirty seconds while the tuner seeks the proper matching settings.

If monitoring SWR on the meter, you should see the tuner select the lowest possible reading. When the **WAIT** indication on the display turns off, you are ready to transmit (assuming the **HI SWR** indicator didn't come on).

Once you have used the antenna tuner, the green **TUNER** LED remains on (unless you press the **TUNER** button to switch the tuner off). If the tuner found a match, the **WAIT** indicator will occasionally flash when you change frequency (while receiving), as the main microprocessor reports the frequency change to the tuner coprocessor (reception is unaffected). The tuner coprocessor compares the current frequency with its memories, and resets itself to the new range if it has any previously stored settings for that range. However, when you first connect a new antenna, the tuner does not have the correct settings stored in these memories, so you need to "train" the tuner, by pressing the **START** button whenever you change to a new frequency range (for this antenna).

## SSB Transmission

To transmit in LSB or USB mode:

- Make sure the appropriate mode indicator to the left of the tuning knob is lit, and press the **ALC** button/LED so it lights. The meter now shows automatic level control voltage when you transmit. This is negative feedback to the transmitter amplifiers that prevents overdriving the finals (higher ALC indicates greater reduction of RF amplification).
- If this is the first time you are transmitting SSB with the FT-890, preset the **MIC** control to about 12 o'clock, the **RF PWR** control fully clockwise, and make sure the **VOX** is off (■).
- Confirm that the display shows the frequency you want to transmit on.

- ❑ Listen carefully on the frequency to make sure you will not interfere with any other stations. Then, if you have an automatic antenna tuner option, press **START** to match the antenna.
- ❑ After "WAIT" disappears from the display, press the PTT (push-to-talk) switch on your microphone, and give your callsign (to identify your transmission) or make your call. You should see the meter fluctuate as you speak.

*Note:* Adjusting the **MIC** control for proper ALC indication on the meter requires that the SWR be below 1.5:1. Otherwise the ALC meter may behave erratically.

- ❑ To find the optimum setting of the **MIC** control for your microphone, begin with it fully counterclockwise (minimum), and adjust it while the **RF PWR** control is fully clockwise. Speak into the microphone (at a normal level) so that the meter deflects no further than mid-range (the upper end of the blue ALC range) on voice peaks. This will normally be about the 10-o'clock position with the MH-1B8 or MD-1C8 microphone.
- ❑ You can press the **PO** button/LED and adjust the **RF PWR** control for less output power, as indicated on the second meter scale from the top. We recommend using the lowest power output possible to maintain reliable communications — not only as a courtesy to other stations, but to minimize power consumption and the possibility of causing RFI and TVI, and to maximize the life of the equipment.

### Microphone Tone Selection

Before setting up the speech processor, set the selector switch on your microphone for the desired audio characteristic. The higher-numbered setting(s) suppress low frequencies. See page 5.

### AF Speech Compressor

Once you have found the proper **MIC** control setting (with full power) and selected the microphone tone characteristic, you can activate the speech compressor to increase the average power of your signal. The **RF PWR** setting does not affect speech processor adjustment.

- ❑ Press the **ALC** button/LED, and the **PROC** button just below it, so that the LEDs in both buttons light. Now speak into the microphone and adjust the **MIC** control slightly, if necessary, so the meter needle stays within the thick blue ALC zone on the bottom scale.
- ❑ The **COMP** control on the rear panel (the shaft nearest the antenna jack) sets the degree of compression. This control is preset to the 12-

### IF Processor Frequency Shift

The *frequency-shifted processor* in the FT-890 lets you shift the IF passband (and hence the RF passband as well) of your transmitted signal in SSB and AM modes, to customize your signal for your own voice characteristics. LSB, USB and AM IF offsets are set independently.

To display the current transmitter offset for the selected mode (LSB, USB or AM), hold the **FAST** button and press **PROC**. The display changes to 3 frequency digits indicating the current offset in kHz, and an "F" at the right. While this is displayed, the offset can be set between -0.30 (-300 Hz) and 0.50 (+500 Hz) for SSB or between -3.00 (-3 kHz) and 3.00 (+3 kHz) for AM by turning the tuning knob. A minus sign indicates the offset is closer to the carrier (low-frequency speech audio emphasized). You can transmit during the display and adjustment. When done, press **PROC** again to return the display to normal.

Of course you can adjust the offset by trial-and-error on the air, but it is better if you have a separate receiver in which you can hear the effect yourself. Otherwise, we recommend starting with +100 Hz offset initially, to add some "crispness" to your processed speech.

To obtain the same result on both USB and LSB, just set them for the same offset display.

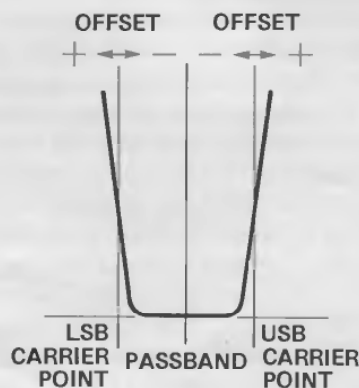

o'clock position at the factory, which provides about 10 dB of speech compression with an average voice pitch. Setting it for more compression can seriously distort your signal, so it should only be adjusted if you have some means of monitoring the transmitter. You can do this with an external receiver, if you have



one, or by having another station give you signal reports as you adjust it.

- If you adjust the **COMP** control, you should recheck your **MIC** control setting as described in the step before last.

### VOX (Voice-Actuated T/R Switching)

In VOX operation, your voice causes transmit/receive switching merely by speaking into the microphone, without having to press the PTT. For the VOX circuit to operate properly, three controls on the rear panel must be set to match your microphone and the acoustic environment of your station. Once set, these trimmers should not require readjustment unless you change your microphone or station location.

- First set the receiver for normal volume on a clear channel, and preset the **VOX GAIN** control (nearest the power jack) on the rear panel fully counterclockwise. Also preset the **ANTI-TRIP** and **DELAY** controls (next to the **VOX GAIN**) to mid-range.
- Set the **RF PWR** control fully counterclockwise (to avoid creating interference while you set up the VOX controls).
- Now press the **VOX** switch near the upper left corner of the front panel to activate VOX (—).
- Without pressing the PTT switch, speak continuously into the microphone while slowly advancing the **VOX GAIN** control clockwise (as viewed from the rear), just until your voice keys the transmitter.
- Now speak intermittently into the microphone, and note the "hang time" between the moment you stop speaking and when the receiver is reactivated. This period should be

just long enough so that the transmitter remains keyed between words, but drops back to receive during pauses. Adjust the **DELAY** control (third from the right), if necessary, for comfortable hang time.

The **ANTI-TRIP** control probably needs no adjustment, but if you find that, with the microphone in its normal operating position, receiver audio from the loudspeaker trips the transmitter, advance the **ANTI-TRIP** control more clockwise (as viewed from the rear). On the other hand, if VOX keying seems sluggish or unstable when you speak into the microphone, try a more counterclockwise setting.

*Note:* if VOX operation is unstable despite these adjustments, RF feedback from the antenna or feedline may be getting back into the transmitter. Make sure your antenna is properly matched, and that your antenna or feedline is not radiating near the transceiver.

### CW Transmission

There are several types of CW transmission available with the FT-890. All require, of course, that you have a CW key or paddles connected to the **KEY** jack on the rear panel (*with a 3-contact plug only - see the drawings below*). There are no critical adjustments for the transmitter: you just use the **RF PWR** control to set your output power. You may also wish to set the sidetone volume, as described in the box on the next page.

- Begin by pressing the **PO** meter selector button/LED. Of course you must have CW mode selected, and for now, make sure the **BREAK-IN** slide switch on the top panel is in the **SEMI**

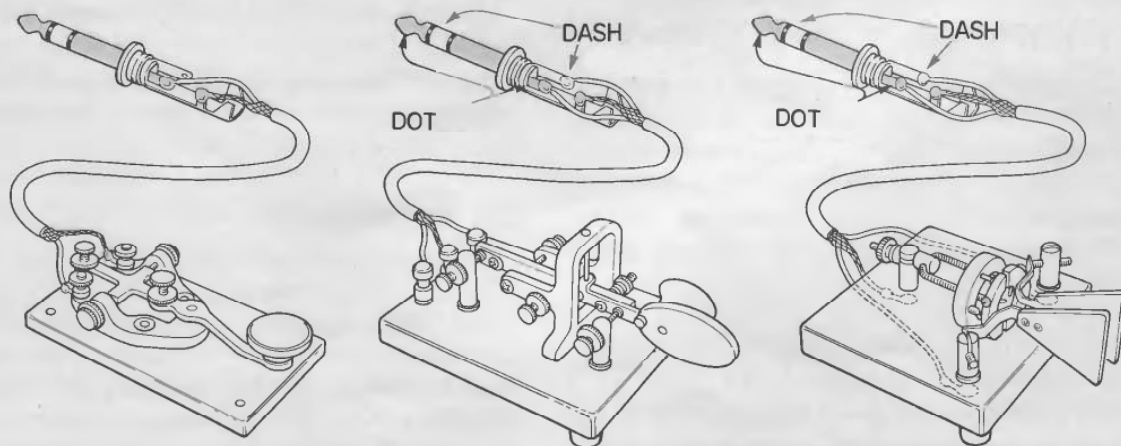

CW Key or Paddle Connections

position (right), and the **KEYER** slide switch is in the **MAN** position (left).

- Press the **VOX** button to turn on the VOX circuit, which in CW mode provides automatic transmitter activation when you close the key.
- Now you can adjust the **RF PWR** control for the desired power output. Note that if you select less than maximum power output and press the **ALC** meter selector button/LED, the meter reading will deflect beyond the ALC zone. This is perfectly normal, and does not degrade your signal.
- Release the key to return to receive.

Courtesy of the VOX circuitry, you are now using semi break-in CW, in which the transmitter remains keyed except during pauses in your sending. You can set the "hang time" during which the transmitter remains on after you stop sending, by adjusting the **DELAY** control on the rear panel. This is the same control used in VOX operation, and will affect VOX switching too, so you may need to choose a compromise setting.

If you prefer full break-in (QSK) operation, in which the receiver is activated between each dot and dash, simply slide the **BREAK-IN** switch to **FULL** (left).

### Using the Internal Electronic Keyer

You will need to connect keyer paddles to the **KEY** jack to use the keyer (see previous page).

- Once you have set up CW transmission as just described, you can activate the keyer with the **KEYER** slide switch on the top panel, by sliding it to the **AUTO** (center) position.

### Sidetone & Button Beeper Volume

The volume of the CW sidetone and that of the beep that sounds when you press a front panel button can be adjusted by a single trimpot located in the hole just in front of the rear bumper on the left side of the set. First set the **AF** control for normal volume on a received signal or noise, then use a small screwdriver to adjust the trimpot either while closing your key or while pressing a button (unless you have disabled the beeper). This volume setting is independent of the receiver volume.

Note that the pitch of the sidetone is fixed at about 700 to 800 Hz, and cannot be adjusted.

- Now squeeze the paddles, and adjust the **SPEED** slide potentiometer on the top panel for the desired speed.

With the **KEYER** switch in the **AUTO** position, dot:dash weighting is 1:3. If you prefer a heavier (1:4.5) weighting, slide the **KEYER** switch to the **WT** (rightmost) position.

The keyer works for both semi and full break-in keying, as described in the previous section.

### AM Transmission

Transmitter power output in the AM mode must be limited to 25 watts (carrier) with the **RF PWR** control. Setting it for higher levels reduces readability. After setting the power level, you need to adjust the **MIC** control to avoid overmodulating. This setting will be lower than the optimum SSB setting.

- VOX and the speech processor can both be used in the AM mode, but for now, make sure the **VOX** and **PROC** buttons are off, so as not to confuse adjustments.
- With the **AM** mode selected, press the **PO** meter selection button/LED. After listening to make sure the frequency is clear, close the PTT switch and, without speaking into the microphone, adjust the **RF PWR** control for 25 watts (or less) on the meter (the upper markings on the second scale from the top).
- Now press the **ALC** button/LED, close the PTT switch, and speak into the microphone while adjusting the **MIC** control just to the point where the meter *begins to kick up slightly* at the low end of the ALC scale. Do not set the **MIC** control further clockwise than this, or your signal will be distorted.
- Reduce the **RF PWR** control, as necessary, for the necessary output level.

See also *Processor Frequency Shift* in the box on page 18 for details on setting up the speech processor for AM.

### FM Transmission

For FM transmission, the only control to be concerned about is **RF PWR**. Microphone gain for FM is preset internally and normally needs no adjustment after leaving the factory. Just set the **METER** selector to the **PO** position, and adjust the **RF PWR** control for the desired output while transmitting. To avoid overheating, if you need full power, keep your transmissions to *three minutes or less*, with the same time for reception.

You can use the VOX for t/r switching, if desired. See also the box on *FM Repeater Operation*.

### FM Repeater Operation

The FT-890 includes several features specifically intended for operation on FM repeaters above 29 MHz.

To locate these repeaters, you can ask around the calling channel (29.6 MHz), or you may want to load a block of memory channels (page 23) with 20-kHz frequency multiples from 29.62 to 29.68 MHz (and FM mode, of course). Then set the squelch so that the receiver is silent on a clear channel, and press the mic buttons to scan the memories.

When you find a repeater, press the **RPT/T** button once for “-” shift (to transmit below your receiving frequency). Pressing it again will select “+” shift, but this is not commonly used above 29.6 MHz. Press it once more to return to simplex.

Try a quick ID transmission to make sure you have the shift right (by default, the FT-890 also automatically transmits a low-level 88.5-Hz subaudible tone during FM Repeater transmissions, to access repeaters that require it).

Once you have made contact through the repeater, you can store the frequency, mode and repeater shift/CTCSS settings in memory (page 23) for later recall.

If the repeaters you usually access have an offset other than the standard 100 kHz, you can adjust the FT-890 offset by turning it off and then back on while holding the **RPT/T** button. This displays the offset, which can be set between 0 and 200 kHz using the tuning knob. Press **RPT/T** once more when done.

Also, if your usual repeaters require a CTCSS tone other than 88.5 Hz, you can display and select another tone by holding the **FAST** button while pressing **RPT/T**, turning the tuning knob, and pressing **RPT/T** again (to accept). The tone you select applies only to the current VFO, but can be stored in memory. The available tone frequencies are listed on page 35.

### Clarifier (Receiver Offset Tuning)

The **CLAR** button and knob near the right side of the front panel let you offset the receiving frequency from that originally displayed (and used for transmission), in 10-Hz steps.

Perform the following steps, if you like, to familiarize yourself with the clarifier controls:

- Press the **CLAR** button and notice that “**CLAR**” appears near the top center of the display. If any clarifier offset has been tuned before, the frequency display shifts accordingly. Turn the **CLAR** knob and notice that the frequency display changes. Now press the **CLAR** button again several times: the operating frequency returns to its “unclarified” setting when the clarifier is off, and adds the offset (to the receive frequency only) when the clarifier is on.
- With the clarifier on, press the PTT switch and notice that the transmit frequency remains the same as the original (that is, non-offset) frequency display.

A typical application for the clarifier is when you are in contact with a station whose transmitter drifts (or perhaps you were not both precisely tuned to the same frequency when you started). You don't want to change your transmitting frequency, as that would force them to retune — you just want to adjust your receiver. To do this, you can press the **CLAR** button to activate the clarifier, and carefully retune their signal with the **CLAR** knob.

After you finish your conversation, you must remember to press the **CLAR** button again to turn off the clarifier. You also might want to clear the offset (by adjusting the **CLAR** knob) before turning it off.

The FT-890 actually has an independent clarifier for each VFO, on every band, plus two on each of the 32 memories. This means clarifier offset settings do not carry over when you change VFOs, bands or memory channels, but are stored until you return to that VFO, band or memory again and reactivate the clarifier.

### VFO B & Split Frequency Operation

As already mentioned, VFO B works exactly like VFO A, although each is totally independent of the other. You can use VFO B as a general-purpose “instant recall” memory. In the FT-890, VFO B has two important purposes: to double memory storage capacity (described in the next section), and to facilitate split-frequency operation (receiving on one VFO, and transmitting on the

other). The special case of split-frequency FM repeater operation uses some features of its own, as described in the box on the previous page. Also, if the difference in transmit and receive frequencies is less than 10 kHz, using the clarifier function is likely to be the easiest approach.

Use the **A/B**, **A=B**, **SPLIT** and **M-VFO** buttons at the right end of the display to set up the two VFOs:

- A/B** toggles operation between the two VFOs, without affecting the contents of either.
- A=B** copies the contents of the currently displayed VFO (A or B) to the other (B or A, respectively), overwriting the contents of the non-displayed VFO.
- SPLIT** toggles the "hidden" VFO for transmission.

- M-VFO** copies the pair of frequencies stored in a memory into the VFOs (by pressing it for  $\frac{1}{2}$  second). This is described in the next section on memory storage and recall.

For split operation, you need to first load the VFOs with the desired transmit and receive frequencies and modes. Set your mode and frequency for transmission, then press **A/B** and set your mode and frequency for reception. You can use the **A/B** button to check your transmit frequency while receiving (to avoid transmitting unnecessarily). Once the two VFOs are set up, just press the **SPLIT** button. "SPLIT" appears in a box at the left edge of the display, and when you transmit, the display frequency shifts to the other VFO (and mode button indicator, if different). The contents of both VFOs can be stored in a memory for future operation with the same frequency pair, as described next.

### Tuning Knob Torque Adjustment

If the tuning knob is too tight or too loose for your preference, and if you have a 2-mm ( $\frac{5}{64}$ " ) Allen wrench, you can adjust the torque.

- Pull the knurled rubber ring off of the tuning knob.
- Locate the hole in the edge of the tuning knob, and use the Allen wrench to loosen the setscrew accessible through the hole,

just enough to allow the knob to be pulled off the shaft.

- Turn the exposed shaft tension spring counterclockwise to loosen the torque, or clockwise to tighten.
- Replace the knob, tighten the setscrew, and replace the rubber ring.



## Memory Features

The 32 memories in the FT-890, labelled 01 through 30, P1 and P2, each store a pair of frequencies and modes, plus wide/narrow IF selections (for CW and AM modes), clarifier on/off and offset settings, plus split frequency status. When you recall a memory, one set of these operating parameters is displayed, and the other set is hidden. For brevity, we will refer to the displayed set of parameters as the *front half* of the memory, and the hidden set as the *rear half*. The front and rear halves can be toggled by the **A/B** button, just as you can toggle the A/B VFOs when operating on a VFO (although the display gives no indication of which half is which, as it does with the VFOs). Like VFO operation, you can operate split with the two halves, receiving on the front and transmitting on the rear; and you can freely tune and change the mode or clarifier settings of whichever half is displayed while receiving. You can also copy a pair of settings from one memory to another. In fact, you can do nearly anything with the two halves of a memory that you can with the A/B VFOs, except for a few differences in tuning steps, scanning (only the front can be scanned) and the special P1 and P2 memories, described later.

## Memory Storage

Storing a memory while operating on either VFO copies the contents of both VFOs (A and B) into the current memory number (displayed in small numbers at the right). Just press and hold the **VFO-M** button for  $\frac{1}{2}$  second. We'll begin with a simple example of storing only the currently displayed frequency into the front half of a memory (the non-displayed VFO is also stored in the rear half, but we can ignore it for now).

**Example:** to store 14.25 MHz from a VFO into memory 10.

- First press **VFO/M**, if necessary, so that either "**VFO-A**" or "**VFO-B**" appears at the left. Select the desired mode, then tune the display to the desired frequency (14.250.00) using the **HAM/GEN** and **DOWN/UP** buttons to change bands and tune in 100-kHz steps, and then the tuning knob as needed.
- Next press the yellow-labelled **VFO-M** button momentarily so that "**M CK**" appears blinking above the frequency display, and within 3 seconds, press the **DOWN** or **UP** button until "**10**" (the memory number to store) appears in small digits at the far right. If nothing was

stored there before, the frequency display will be blank.

- Now hold the **VFO-M** button for  $\frac{1}{2}$ -second. Two beeps sound to confirm the memory was stored.

Although we ignored it, keep in mind that when we stored the displayed VFO, the hidden one was also stored in the rear half of the same memory. You could have pressed the **A/B** button after setting up the first VFO and then set up the other before storing them. Both are always written to memory, overwriting whatever may have been stored there previously. In addition, the clarifier on/off state and offset for both VFOs are also stored in the memory (whether or not the clarifier is activated).

## Checking Memory Contents

Before storing or recalling a memory, you will usually want to check its contents. If you are operating on a VFO, you can of course just press **VFO/M** to recall the last-used memory, but this has disadvantages: any current operation is interrupted as your frequency changes, the antenna tuner retunes (if installed), and you'll have to press **VFO/M** again to get back to the VFO. Also, this will not work if you are operating on a retuned memory: you will lose any changed settings entirely! So, the FT-890 offers a way to display the (front) contents of memories without affecting current VFO (or retuned memory) operation, and requiring only one key press. We call it *memory checking*, and you already did it in the preceding example.

You activate memory checking by momentarily pressing either the **VFO-M** or the **M-VFO** button. As you saw above, "**M CK**" blinks near the top right of the display as the frequency and mode indicators change to show the contents of the last-selected memory. If you touch nothing else, the display reverts to your current operating parameters automatically after 3 seconds. By pressing the front panel **DOWN** or **UP** button before the 3 seconds expires, you can select for display the front half of each of the 32 memories. Pressing these buttons restarts the 3-second timer, so as long as you are changing channels, memory checking mode persists.

While checking memories, the memory number shows at the right end of the display (instead of the 10-Hz frequency digit, if you have set that up). Also, when you select a vacant memory, the mode indicators and frequency display go blank (except the decimals).

Still, memory checking does not show you everything you've stored; it only shows the visible front half of the memory. To display the frequency, mode and clarifier settings stored from the other VFO you have to recall the memory and press the **A/B** button. So, when storing memories with the intention of using both halves (front and rear), it is a good idea to have them related in some way so that you can recognize both later when only the contents of the front half appear.

### Memory Recall & Operation

To recall data stored in a memory for operation, you can either copy it into the VFOs, or you can switch operation from the VFOs to the memories. Since you can freely tune any memory, copying it to the VFOs only gives you the advantage of **VFO-A** or **VFO-B** display indication.

Holding the **M-VFO** button for  $\frac{1}{2}$  second copies the current memory channel data into the VFOs. Pressing it only momentarily shows you the contents of the memory, without actually overwriting the VFO data. Otherwise, when you press and hold this button, you lose the previous contents of both VFOs, and if you were receiving on a VFO, operation shifts to the frequency and mode copied from the memory (and now in the VFO).

In most situations you may find it more convenient simply to switch operation from the VFO to the memory, by pressing the **VFO/M** button. This method allows you to leave any settings in the VFOs undisturbed, so you can instantly recall them just by pressing **VFO/M** again.

When actually operating on a memory (if you haven't retuned it), "**MEM**" is displayed at the left (instead of "**VFO-A**" or "**VFO-B**"), and you can press the **DOWN/UP** buttons on the panel (or the microphone buttons) to select any previously stored memory for operation. You cannot activate memory checking or copy the recalled memory directly to another memory, as the function of the **VFO-M** button changes as described later under *Memory Blanking*.

However, there is an easy way to get this button to work the same as it does on the VFOs, and to regain the memory checking feature: if you change frequency, mode or clarifier settings, or if you press **A/B** to switch front and back halves, "**MEM**" on the display is replaced with "**M TUNE**" (but see the box below). In this *memory tuning* mode, the functions of several buttons differ from the ordinary memory recall mode:

### Frequency Display Modes

VFO display with 10-Hz digit activated (page 14).

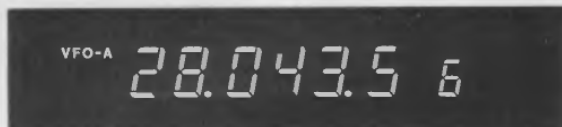

Press **VFO/M** to switch to MEM mode.

MEM mode display of memory 18 with same frequency. Note that 10-Hz digit is not displayed, although it is stored.

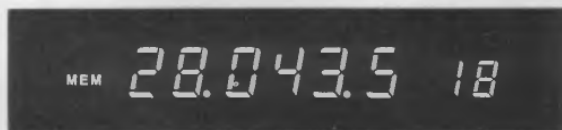

Touch the tuning knob or microphone **UP/DWN** button to switch to M TUNE mode.

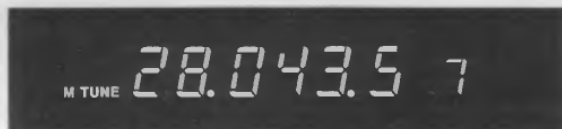

M TUNE mode display of retuned memory 18 (+10 Hz). Press **VFO/M** once to cancel changes and revert to MEM mode, and press it again to return to VFO mode.

the **DOWN/UP** buttons select ham bands or 100-kHz steps (as when operating on the VFOs), the microphone buttons duplicate the tuning knob functions instead of the front panel **DOWN/UP** buttons, and the **VFO/M** button cancels any changes to the memory and returns you to the memory recall mode ("**MEM**" displayed again), instead of switching to the VFOs.

The memory tuning mode makes operation on memories 01 to 30 just as flexible as the VFOs (memories P1 and P2 have special additional features, described later). If you want to save changes to a memory channel, use the same procedure you use to store the VFOs to memory: Press **VFO-M** momentarily and the **DOWN/UP** buttons to select another memory (if desired), or just hold **VFO-M** for  $\frac{1}{2}$ -second until the double

### Clarifying Memories, and M TUNE

As shipped from the factory, the FT-890 will automatically activate the "**M TUNE**" indicator if the clarifier is activated while receiving on a memory. If you prefer to have the memory stay in the normal ("**MEM**") memory mode in this situation, press and hold the **NB** button while switching the set on. Repeat the same procedure to cancel the change.

beep sounds (to overwrite the current memory with the retuned data). The labelling of the **VFO-M** button is somewhat deceptive here: the VFO settings, which are hidden at this point, are not involved in this operation at all, since those of the recalled memory have taken their place.

As mentioned above, if you just want to cancel any changes you have made to a recalled memory, press **VFO/M** once ("MEM" is displayed again), and press it again if you want to return to the VFOs. The display mode changes are summarized at the top of the previous page.

Split operation can be enabled and stored in a memory, in which case the rear half of the memory is used for transmission. Similarly, pressing the **A/B** button while receiving on a memory switches operation between the front and rear halves of the memory (don't forget both of these functions also activate memory tuning).

### Memory Scanning

When receiving on a recalled memory (with "MEM" displayed), you can scan the front halves of all stored memories. Just hold the microphone **DWN** or **UP** button for  $\frac{1}{2}$  second to start. If you want scanning to pause on signals, you must first adjust the **SQL** control to silence the receiver (**BUSY** LED right of the meter off) on a clear channel. Scanning pauses on any channel having a signal strong enough to open the squelch, and the two decimal points in the frequency display blink. By default, scanning resumes only after the signal disappears. Alternatively, you can also have scanning resume automatically after 5 seconds. To toggle these scan-resume modes, turn off the transceiver and turn it on again while holding the **VFO/M** button.

You may need to readjust the **SQL** control to prevent scanning from stopping on only background noise.

To stop scanning press the **PTT** switch (no transmission will occur), or a microphone button again. When scanning, keep in mind that the **IPO** and **ATT** buttons and **RF** gain setting also affect the squelch threshold.

### Memory Scan Skip

Once you have stored many memories, you probably won't want to scan every one of them. You can mark some of them to be skipped during scanning. To do this, recall the memory to be skipped, and hold the **FAST** button below the left side of the tuning knob (or on the microphone)

while pressing **VFO/M** momentarily. "SKIP" appears above the memory number at the right.

If you have set a memory to be skipped, and later want to include it, just repeat the **FAST + VFO/M** procedure.

### Memory Blanking

After storing many memories, you may want to completely hide some from normal operation, to simplify selection of the others. To blank a displayed memory, while "MEM" is displayed at the left of the frequency, press and hold the yellow-labelled **VFO-M** button for  $\frac{1}{2}$ -second until the double beep sounds. But be careful: if you do this instead while "M TUNE" is displayed — that is, after retuning the memory, the retuned data will overwrite the original memory data, but it will not be blanked. So, if you have retuned the memory and don't want to save the changes, cancel them first by pressing **VFO/M** once, and then hold **VFO-M** button for  $\frac{1}{2}$ -second.

While a memory is blanked, no frequency digits appear, and "CLEAR" appears above the memory number at the right end of the display.

As long as you don't overwrite a blanked memory, you can unblank it simply by repeating the same procedure you used to blank it.

### Band & Subband Scanning:

#### Subband Limit Memories P1 & P2

As you have probably already discovered, when operating on a VFO or retuned memory, holding either the **DWN** or **UP** button on the microphone for  $\frac{1}{2}$  second starts scanning, and pressing one of these buttons again stops it. By setting the **SQL** control so that the receiver is just silenced on a clear frequency, scanning will pause when it finds a signal, and resume according to the scan-resume selection described above under *Memory Scanning*.

You can also increase the scanning step size by 10, by pressing the **FAST** button while scanning (or toggling it on, if you have set it to work that way — see page 12).

If you let scanning continue indefinitely, it will loop around when it reaches 0 or 30 MHz, including the entire range of receiver coverage. To limit scanning to a particular frequency range, you will want to make use of the programmable scanning limit (we call it *PMS*) facility provided with memories P1 and P2.

To limit the tuning range to a particular subband, store the edges of the range in memories P1 and P2. Then recall either memory and activate memory tuning. Tuning and scanning now loop around the ends of the stored range, keeping operation inside the programmed subband.

You can change modes and use the clarifier as when retuning any other memory, but don't bother to press **A/B** to switch halves of the memory, or press the **DOWN/UP** buttons: as soon as you try to tune with the knob or microphone buttons, operation instantly switches back to the subband. Also, if you activate split transmit/receive, your transmit frequency will be whatever you stored in the back half of the memory you started on (P1 or P2).

**Example:** Limit tuning and scanning to the 17-m WARC band.

- Press **VFO/M** once or twice, if necessary, to display either "**VFO-A**" or "**VFO-B**" at the left. Then tune to the low edge of the 17-m band: 18.068 MHz. Also select the mode you expect to use most often (here, USB or CW).
- Press **A/B** to select the other VFO, and tune to the high edge of the 17-m band: 18.168 MHz. Again, select a mode you expect to use (it does not need to be the same).
- Press **VFO-M** momentarily to activate memory checking, and press the **DOWN/UP** buttons to select memory P2 at the left. Then hold **VFO-M** for  $\frac{1}{2}$  second to write the two VFOs to the memory. That takes care of the high edge.
- Press **A/B** to select the other VFO with the low band edge.
- Press **VFO-M** momentarily to activate memory checking, and press the **DOWN** button to display memory P1. Then hold **VFO-M** for  $\frac{1}{2}$  second to write the VFOs to memory P1 (with front and back reversed from memory P2). That stores the low edge into the front of memory P1.
- Press **VFO/M** to recall memory P1, and turn the tuning knob (to activate memory tuning).

Tuning and scanning are now limited to the 18.068- to 18.168-MHz range until you press **VFO/M** to return to memory channel operations, **VFO-M** to copy the displayed frequency to a memory, or **M-VFO** to write the displayed frequency to a VFO.

In this example, note that we overwrote the rear half of each memory with data we didn't need. For this reason, you may want to use the P1 and P2 memories only for subband-limited

operation. In fact, if you want to make optimum use of this feature with the band-independent VFOs, you could keep all VFO-As (that is, on each amateur band) set to the low edge of the subband you use, and all VFO-Bs set to the high edge. By using the above procedure to load the P1 and P2 memories when you change bands, and operating only in the memory tuning mode on the P1 or P2 memory, you can have the subband limits always enabled and never use the VFOs (except for storing the band limits).

Of course you don't have to use the VFOs to set up or store subband limits all the time, and for non-amateur-band subbands, such as the HF broadcast bands, you indeed cannot store the subband limits in the VFOs. Fortunately, since the **VFO-M** button lets you copy between memories when memory tuning is active, you can use the regular memories (01 through 30) for storing subband limits. The back halves of the P1 and P2 memories serve to simplify this process, as illustrated in the next example:

**Example:** Use memory 19 to store the 19-m short-wave broadcast band edges.

- Press **VFO/M** once or twice, if necessary, until either "**VFO-A**" or "**VFO-B**" appears at the left. Then tune to the low edge of the 19-m band: 15.100 MHz. Also press the mode button for the mode you expect to use most often (USB, LSB or AM wide or narrow).
- Press **A/B** to select the other VFO, and tune to the high edge of the 19-m band: 15.600 MHz. Again, select a mode you expect to use (it does not need to be the same).
- Press **VFO-M** momentarily to activate memory checking, and press the **DOWN** or **UP** button to select memory 19 at the left. Then hold **VFO-M** for  $\frac{1}{2}$  second to write the two VFOs to the memory.

Now, to use the stored subband limits, you need to copy them from the regular memory to the front halves of the P1 and P2 memories:

- Press **VFO/M**, if necessary, to select memory recall operation ("**MEM**" displayed at the left), and press the **DOWN** or **UP** button, if necessary, to select memory 19, where the 19-m band limits are stored. The frequency displayed should be 15.600 MHz if the above example was successful.
- So far in this example, we have stored the high band edge in the front half of the memory, and the low band edge in the rear half. We want to copy the low edge into memory P1, and the high edge into memory P2 (although we



could do it the other way too). Also recall that we must change to the memory tune mode to copy one memory to another. So, by pressing the **A/B** button now, we can accomplish two things at once: the low edge (15.100 MHz) stored in the rear of the memory comes to the front, and the memory tune function is activated ("**MEM**" is replaced by "**M TUNE**" at the left).

- Now press **VFO-M** momentarily to activate memory checking, and press the **UP** button to display memory P1. Then hold **VFO-M** for  $\frac{1}{2}$  second to write memory 19 to memory P1. That takes care of the low edge, and also shifts operation to memory P1 with memory tuning activated.
- Press **A/B** to select the other half of memory P1, which now holds the high band edge (copied from memory 19 in the last step).
- Press **VFO-M** momentarily to activate memory checking, and press the **UP** button to display memory P2. Then hold **VFO-M** for  $\frac{1}{2}$  second to write memory P1 (with front and back reversed) to memory P2. That stores the high edge into the front of memory P2, and leaves operation in the memory tuning mode on memory P2: just where we want to be.

Now when you tune or scan, operation remains within the 15.100- to 15.600-MHz range.

## Digital Modes

The FT-890 offers a few special features for digital modes, such as the **DATA IN/OUT** jack on the rear panel, and a very fast transmit-to-receive turnaround time. This provides good performance on 1200-baud packet above 29 MHz. Unfortunately, optimum AMTOR, RTTY and 300-baud packet operation is difficult, because the optional 500-Hz narrow CW filter is not available for reception in the SSB modes needed for AFSK transmission. You can keep operation simple (and avoid the need for the 500-Hz CW filter option) by using the LSB mode with its 2.4-kHz bandwidth for both transmission and reception, but the broad receiver IF bandwidth is not optimum for receiving narrow-shift AFSK. Alternatively, if you have the 500-Hz CW filter installed, you can try using it for reception in CW mode and transmitting in an SSB mode; but this requires offsetting your transmit and receive frequencies, along with a few other niggles.

### TU/TNC Interconnections

Connect your TU or TNC to the **DATA IN/OUT** and **PTT** jacks on the rear panel, as shown below. The schematic on the next page shows the relationships of the transmitter audio inputs at the **MIC**, **PATCH** and **DATA IN/OUT** jacks. Input impedance at the tip contact of the **DATA IN/OUT** jack is about 3-k $\Omega$ , and peak input voltage should be 20 to 40 mV, so you may need to adjust the output level from your TU or TNC. Also, you will need to disconnect the microphone to avoid transmitting shack noise on top of your signal.

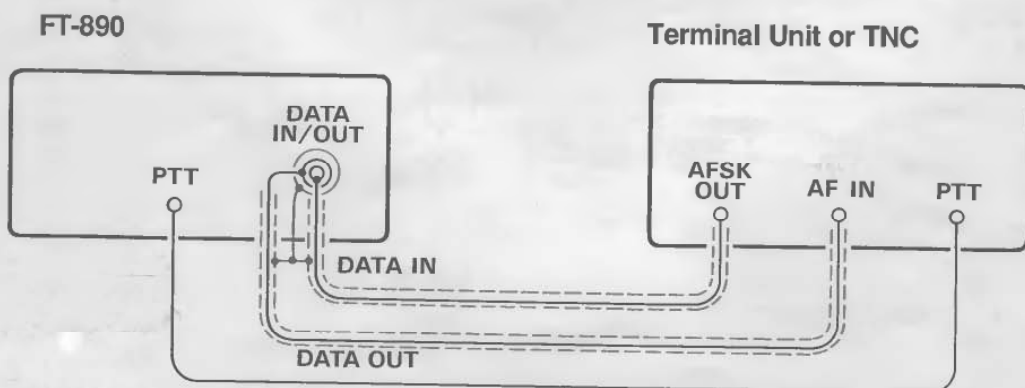

Packet TNC and RTTY/AMTOR Terminal Unit Interconnections

Peak output voltage at the ring contact of the **DATA IN/OUT** jack is about 30 mV at 600 Ω, so you may also need to adjust the input level inside your TU or TNC.

### Transmitter Adjustment

Press the **AGC-F** button for fast AGC, and the **LSB** mode button for normal shift. The display shows suppressed carrier frequency, so bear in mind that your actual transmitted signal is offset below the display by the (audio) frequency of the AFSK tones generated by your TU.

Before transmitting the first time, preset the **RF PWR** control to about 12 o'clock, and press the **ALC** meter selector button/LED. Key the transmitter from your keyboard, and adjust the **MIC** control for less than mid-scale indication.

Now you can press the **PO** button/LED, and set the **RF PWR** for the desired power output.

Note that for AMTOR and F1 packet operation, you must have the **VOX** button off (■) for fast transmit/receive turn-around.

### Frequency Display & Tuning

As mentioned above, the transceiver displays the suppressed carrier frequency, from which you must subtract the audio frequency of your TU's or TNC's AFSK tones to find the actual operating frequency. For example, if your TNC uses 1600- and 1800-Hz tones, you can subtract

### Caution!

Although the FT-890 cooling system is designed to handle continuous duty transmission at 100 watts output, full key-down output for long periods is not recommended. Especially during hot or humid weather, we recommend reducing power to preserve the life of the components. In any case, during long transmissions, place your hand on the top occasionally to ensure that it's not getting too hot. The safest approach is to keep power output at 50 watts or less during long transmissions.

the difference (1700 Hz) from the display to find the actual center frequency of your transmitted signal. Also, you want to center your receiver audio passband at 1700 Hz, so you need to turn the **SHIFT** control counterclockwise to about the 11-o'clock position (the normal SSB passband is centered about 1500 Hz away from the carrier frequency).

Of course, if your TNC or TU uses higher-frequency tones, you have to shift the passband further.

**Example:** You want to have a packet QSO with a station who has told you they will be on 14.1013 MHz (sometimes called the old "14.103" accord-

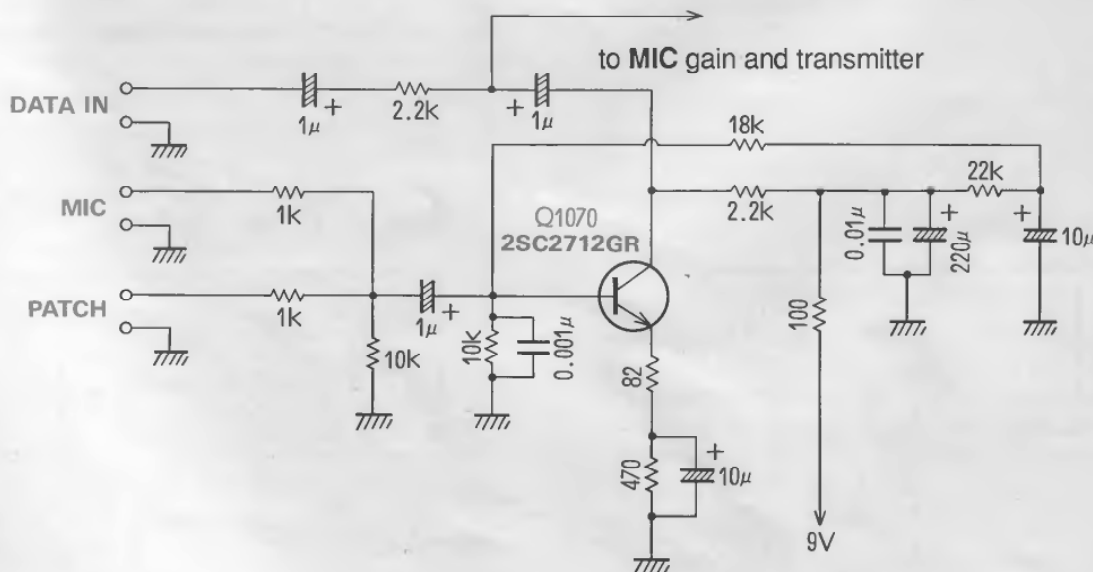

Transmitter AF Input Relationships

ing to the 1700-Hz TAPR convention), and your TNC uses 2115-/2315-Hz tones (like the MFJs). What frequency should your display show?

Unlike RTTY and AMTOR, which imply the mark frequency when setting up skeds, packet frequencies refer to the center of the two tones. With your modem, the carrier offset is in the middle between 2315 and 2115 Hz, or 2215 Hz. So if you're using LSB mode, you need to add this offset to the specified QSO frequency to get your displayed frequency:  $14.10130 + 0.002215$  (MHz) = 14.103515, which displays as either 14.103.51 or 14.103.52. On the other hand, if you're using USB mode, you subtract the offset, and your display shows 14.099.08 or 14.099.09.

Since tuning is very critical for F1 packet, you should enable display of the 10-Hz digit, by

holding the **UP** button while switching the transmitter on. Tune the transmitter and receiver within 10 Hz of a signal to minimize repeats.

### **1200-Baud FM Packet**

The equipment setup for 1200-baud FM packet (above 29 MHz) is the same as for 300-baud packet. There is no squelch output from the FT-890, however, so performance will be better on noisy channels if your TNC has PLL-type DCD. Tuning is much less critical in this mode, requiring no special adjustments.

To transmit FM packet, just press the **PO** meter selector button/LED and adjust the **RF PWR** control for the desired power output.

### Optional DVS-2 Digital Voice Recorder

The DVS-2 is a digital recorder that can greatly enhance DXing, voice contesting and net operations. The FT-890 has a special jack for connecting the DVS-2 on the rear panel. It offers two independent functions: recording received signals for playback later in the loudspeaker/headphone, and recording signals by the microphone for playback during transmission. Operating details are provided with the DVS-2, but here is an overview.

#### *Receiver Recording*

In this mode, the DVS-2 maintains a continuous recording of the last 16 seconds of audio from the receiver. This can be particularly helpful in picking out callsigns during a pileup or net check in, as you can replay the

same recording with the push of a button, as many times as you need, without having to ask for retransmissions.

#### *Transmission Recording*

This mode allows the DVS-2 to record either two 8-second segments or four 4-second segments of audio from the microphone, such as contest exchanges, station IDs or net calls. Each can then be played back, either in a monitor mode (without transmission), or directly over the air. The 8- and 4-second segments share the same memory, so two 4-second segments can be combined into one 8-second segment. The digital memory used in this mode is independent from that used for receiver recording.

# CAT System Computer Control

The CAT (Computer Aided Transceiver) System in the FT-890 provides control of frequency, mode, VFO, memory and other settings by the operator's external personal computer. This allows multiple control operations to be fully automated as single mouse click or keystroke operations on the computer keyboard.

Serial data is passed at TTL levels (0 and +5V) via SO (serial output) and SI (serial input) pins 2 and 3 of the CAT jack on the rear panel of the transceiver, at 4800 bits/s. CAT jack pinout is shown on page 9. Each byte sent consists of one start bit, 8 data bits, no parity and two stop bits:

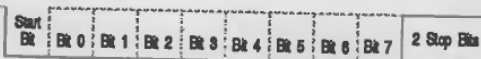

One byte, sent left-to-right

All commands sent to the transceiver must consist of *blocks* of five bytes each, with up to 200 ms between each byte. The last byte sent in each block is the *instruction opcode*, while the first four bytes of each block are arguments: either parameters for that instruction, or dummy values (to pad the block out to five bytes):

## 5-Byte Command Block, Sent left-to-right

4th arg byte	3rd arg byte	2nd arg byte	1st arg byte	Opcode
--------------	--------------	--------------	--------------	--------

There are twenty-six instruction opcodes for the FT-890, listed in the table on the next page. Notice that several instructions require no specific parameters, but every command block sent to the transceiver *must* consist of five bytes.

The CAT control program in the computer must construct the 5-byte block by selecting the appropriate instruction opcode, organizing the parameters, if any, and providing unused (dummy) argument bytes for padding (dummy bytes may have any value). The resulting five bytes are then sent, *opcode last*, to the SI serial input pin of the CAT jack on the transceiver.

**Example:** Tune to 14.25000 MHz;

- First determine the opcode for the desired instruction (see the CAT Commands table, next page). These opcodes should be stored in the program so they can be looked up when the user requests the corresponding command. In this case the instruction is "Set Op Freq", so the opcode is 0Ah. Small "h"s following each byte value indicate hexadecimal (base 16) values.

- Build the four argument byte values from the desired frequency by breaking it into 2-digit blocks (BCD "packed decimal" format). Note that a leading zero is always required in the hundred's-of-MHz place (and another in the ten's-of-MHz if below 10 MHz).
- The resulting 5-byte block should look like this (again, in hexadecimal format):

Byte Value	0Ah	01h	42h	50h	00h
Content of this byte	Set Op Freq. opcode	100's & 10's of MHz	1's of MHz & 100's of kHz	10's & 1's of kHz	100's & 10's of Hz

- Send these five bytes to the transceiver, in *reverse order* from that shown above — from right-to-left (see the examples on page 34).

## Data Returned From FT-890

The *Status Update*, *Read Flags* and *Read Meter* commands cause the FT-890 to report various operational and internally stored settings on the SO (serial output) line:

*Status Update* causes the FT-890 to return all or portions of its RAM table (up to 649 bytes).

*Read Flags* obtains only the first 3 bytes (the Status Flags) from the RAM table, plus 2 extra "filler" bytes (08h and 41h),

*Read Meter* returns the meter deflection (0 — OFFh) repeated in four bytes, followed by one "filler" byte (0F7h).

Each returned byte may be delayed by an interval determined by the *Pacing* command (0 to 255 ms in 1-ms steps). This delay is initially zero until the *Pacing* command is sent. This allows returned data to be read and processed by even very slow computers. However, you should set it as short as your computer will allow, to minimize the inconvenience of the delay. In the worst case, when the radio is to return all 649 bytes of internal data, about 1.4 seconds is required with "0"-length delay selected, but almost 3 *minutes* if the maximum delay is selected!

## Status Update Data Organization

The 649 bytes of *Update* data is organized as shown at the top of the page after next. Aside from the *Read Flags* command, different portions of this data can be returned in blocks of 1, 18, 19 or 649 bytes, depending on the parameters of the *Update* command sent by the computer. The details of these commands follow the descriptions of the data.

## CAT Commands

### Legend:

Send all commands in **REVERSE** order from that shown! Commands that duplicate a front panel button are named with all caps. Parameter variables are named to reflect their format: eg., "CH" indicates a memory number, from 1 to 20h (1 to 32 decimal). "—" indicates a padding byte. Value is unimportant, but it must be present to pad the block out to exactly five bytes. Opcodes are listed in both hex and decimal format for convenience - only one opcode byte can be actually sent.

Command	Opcode		Parameter Bytes				Parameter Description
	hex	(dec)	1	2	3	4	
<b>SPLIT</b>	01	(1)	T	—	—	—	Switch Split tx/rx operation ON (T=0) and OFF (T=1)
<b>Recall Memory</b>	02	(2)	CH	—	—	—	Recalls memory number CH: 1 to 20h corresponding to memories 1 to 30. P1 & P2
<b>VFO ► M</b>	03	(3)	CH	P2	—	—	Copy display to memory CH (P2=0), Hide CH (P2=1) or Unhide CH (P2=2)
<b>LOCK</b>	04	(4)	P	—	—	—	Tuning knob or panel lock/unlock (P=1/0)
<b>A/B</b>	05	(5)	V	—	—	—	Select operation on VFO A (V=0) or VFO B (V=1)
<b>M ► VFO</b>	06	(6)	CH	—	—	—	Copy memory CH (1 to 20h) to last-used VFO
<b>UP</b>	07	(7)	00h	S	—	—	Step current display up 100 kHz (S=0) or 1 MHz (S=1)
<b>DOWN</b>	08	(8)	00h	S	—	—	same as UP, but steps down
<b>CLAR</b>	09	(9)	C1	C2	C3	C4	Clarifier on/off (C1=1/0) or clear offset (C1=FFh). Tune clarifier up/down (C2=0/1) by C3 (kHz) + C4 (Hz)
<b>Set Op Freq</b>	0Ah	(10)	F1	F2	F3	F4	New operating frequency in F1 – F4, in BCD format: see text for example
<b>MODE</b>	0Ch	(12)	M	—	—	—	M values: LSB=0, USB=1, CW-wide=2, CW-nar=3, AM-wide=4, AM-nar=5, FM=6 or 7.
<b>HAM/GEN</b>	0Dh	(13)	HG	—	—	—	Select HAM/GEN stepping functions (H/G=0/1)
<b>Pacing</b>	0Eh	(14)	N	—	—	—	Add N-millisecond (0 – 0FFh) delay between bytes of all data returned from radio
<b>PTT</b>	0Fh	(15)	T	—	—	—	Transmitter on (T=1) or off (T=0)
<b>Status Update</b>	10h	(16)	U	—	—	CH	Instructs the radio to return 1, 18, 19 or 649 bytes of Status Update data. CH is significant only when U1=4. See text.
<b>TUNER</b>	81h	(129)	T	—	—	—	Switch antenna tuner on (T=1) or off (T=0)
<b>START</b>	82h	(130)	—	—	—	—	Start antenna tuner
<b>RPT/T</b>	84h	(132)	R	—	—	—	Select simplex (R=0), –shift (R=1) or +shift (R=2)
<b>A=B</b>	85h	(133)	—	—	—	—	Copy displayed VFO (A or B) data to other VFO (B or A, resp.)
<b>Memory Scan Skip</b>	8Dh	(141)	CH	T	—	—	For memory CH (1 – 20h), skip (T=1) or include in scanning (T=0)
<b>Step Op Freq</b>	8Eh	(142)	D	—	—	—	Step operating freq up (D=0) or down (D=1) minimal step (10- or 100-Hz)
<b>CTCSS Freq</b>	90h	(144)	CC	—	—	—	Select a CTCSS tone for repeater operation. CTCSS Code CC=0 to 20h (see CTCSS Code Table on page 35)
<b>Read Meter</b>	0F7h	(247)	—	—	—	—	Instructs radio to return digitized meter indication (4 repeated bytes, and 0F7h)
<b>Display Brightness</b>	0F8h	(248)	L	—	—	—	Set display brightness L between 0 and 7 (brightest)
<b>Rptr Offset</b>	0F9h	(249)	00h	S2	S3	S4	Set offset for RPT shifts, valid values are 0 to 200,000 Hz (BCD format, in S2 – S4). Parameter 1 must be zero, S2 must be 0, 1 or 2. S3 is 1's & 10's of kHz, S4 is 10's & 100's of Hz.
<b>Read Flags</b>	0FAh	(250)	—	—	—	—	Instructs radio to return the 24 1-bit Status Flags (5 bytes, see following pages)

## All 649 Bytes of Status Update Data (Sent L-to-R)

Flags	M	Operating Data Record	VFO-A Data	VFO-B Data	32 19-Byte Memory Data Records
3	1	19 bytes	9 bytes	9 bytes	608 bytes (32 x 19)
(A)	(B)	(C)	(D)	(E)	(F)

### (A) Flag Bytes

The first 3 bytes are treated as 24 1-bit flag fields: a function is enabled (on) if a bit is set (1), and disabled (off) if reset (0). Most of the functions represented by these flags correspond to the radio display.

#### First Flag Byte

- Bit 0: LOCK is active (= display)
- Bit 1: GEN operation (= display)
- Bit 2: SPLIT operation (= display)
- Bit 3: Memory checking (M CK) in progress
- Bit 4: Memory tuning (M TUNE) activated
- Bit 5: MEM operation (= display)
- Bit 6: VFO B in use for transmit or receive
- Bit 7: VFO A or B operation (= display)

#### Second Flag Byte

- Bit 0: PTT line closed by CAT command
- Bit 1: Memory scanning is paused
- Bit 2: Scanning in progress (paused or not)
- Bit 3: 3-sec mem check (M CK) timer active
- Bit 4: PTT Tx inhibited during memory scan
- Bit 5: Antenna Tuner tuning (WAIT)
- Bit 6: High SWR (= display)
- Bit 7: FAST tuning/scanning rate is activated

#### Third Flag Byte

- Bit 0: 10-watt transmit (model FT-850)
- Bit 1: 50-watt transmit (model FT-850)
- Bits 2 & 3: not used
- Bit 4: CW key is open
- Bit 5: Antenna TUNER on (panel LED)
- Bit 6: Tx inhibit (eg., out-of-band)
- Bit 7: Transmission in progress (PTT closed)

### (B) Fourth Byte: Memory Number

The 4th byte of Update data contains a binary value between 0 and 1Fh (31 decimal), indicating the current memory number -1 (or the last-selected memory, if operating on a VFO).

### (C) 19-Byte Data Records

The Memory Number is followed by a 19-byte record defining current operating conditions. That is, the two VFOs if operation is on a VFO, or the front and rear halves of the current memory if operation is on a memory. This record consists

one byte of *Memory Status* flags followed by two 9-byte *VFO/Memory Data* records:

#### 19-Byte Data Record Format

1 byte	9 bytes	9 bytes
Mem Flags	VFO-A or Memory Front	VFO-B or Memory Rear

#### Memory Status Flags (1 Byte)

This byte is at the head of every 19-byte Data Record. Bits 0 through 5 are not used. Bit 6 is set if the SPLIT function is active on the memory, and Bit 7 is set if the memory is blanked.

#### VFO/Memory Data Record (9 Bytes)

The structure of a 9-byte VFO/Memory Data record is detailed in the table below. Each byte in the table is identified by its offset from the start (base address) of the record, since the same 9-byte record format is also used elsewhere.

#### 9-Byte VFO/Memory Data Record Format

Offset	Contents & Format of Byte Field
0	BPF selection: 0 to 30h binary (bit 7=1 on a blanked memory)
1-3	Bytes 1 — 3: Base frequency in 10's of Hz (w/o clar/rpt offset). Binary value in range 10000 - 3000000. Byte 1 is MSB.
4-5	Clarifier offset. 2's complement (signed) value between -999d (FC19h) and +999d (03E7h)
6	Mode: 0=LSB, 1=USB, 2=CW, 3=AM, 4=FM
7	CTCSS tone code for rpt: 0 to 20h (see CTCSS Code Table)
8	VFO/Memory Operating Flags (see below)

#### VFO/Memory Operating Flags

Each bit in this field signifies a state unique to one VFO or half-memory.

- Bit 0: AM/FM freq. is not 100-Hz multiple
- Bit 1: not used
- Bit 2: Memory set to SKIP when scanning
- Bit 3: - Repeater Shift (for FM only)
- Bit 4: + Repeater Shift (for FM only)
- Bit 5: Clarifier is enabled
- Bit 6: Current mode is AM NARrow
- Bit 7: Current mode is CW NARrow

**(D) & (E) VFO-A and VFO-B Data (9 bytes x 2)**

After the 19-byte Data Record for current operation is sent, two 9-byte VFO/Memory Data Records are sent; one for each VFO. The format of each of these records is the same as described above, and in fact, when operating on a VFO, the values in these records are identical to the two 9-byte records included in the 19-byte Data Record for current operation.

**(F) Memory Data Records**

After the two 9-byte records for the VFOs, 32 19-byte Data Records are sent: one for each memory, beginning with memory 01. Each memory data record is constructed as described above for the 19-byte Data Records.

**Status Update Data Selection**

The 1st and 4th parameters of the Status Update command allow selection of different portions of the Status Data to be returned, as follows ("U" is the 1st parameter, "CH" is the 4th):

Parameters	Data Returned	Ref (see previous page)
U=0	All 649 bytes	A
U=1	Memory Number	B
U=2	19-Byte Operating Data Record	C
U=3	18-Byte VFO-A & VFO-B Data	D & E
U=4, CH=1 ~ 20h	19-Byte Mem Data Record for mem CH	F

Note that, in most cases, you will only need to read the 19-byte Operating Data Record (with the first parameter = 2), since all other CAT commands affect only this data (except VFO ► M and Memory Scan Skip).

**Read Flags Data**

The Read Flags command retrieves the (first) 3 Flag Bytes of the Status Data. The transceiver responds to the Read Flags command by returning the Flag Bytes described on the preceding page, plus two bytes with the constant values of 08h and 41h (in that order), as shown here:

1st Flag Byte	2nd Flag Byte	3rd Flag Byte	Dummy (08h)	Dummy (41h)
---------------	---------------	---------------	-------------	-------------

**Read Meter Data**

Sending the Read Meter command causes the transceiver to return a digitized meter deflection

indication, between 0 and 0FFh (in practice, the highest value returned will be around 0F0h). Four copies of this value are returned, along with one constant byte (0F7h), as follows:

Meter Byte	Meter Byte	Meter Byte	Meter Byte	0F7h
------------	------------	------------	------------	------

During reception, the signal strength deflection is returned. During transmission, the parameter represented by the Meter Byte depends on the current meter selection (ALC, PO or SWR).

**Coding Examples**

Although Yaesu Musen Company cannot offer to provide complete CAT control programs (owing to the variety of incompatible computers used by our customers), following are a few examples of critical CAT i/o functions, in Basic. Note that all variations of Basic may not support some of the commands, in which case alternate algorithms may need to be developed to duplicate the functions of those shown.

**Sending a Command**

After "opening" the computer's serial port for 4800-baud, 8 data bits and 2 stop bits with no parity, as i/o device #2, any CAT command may be sent. However, if you determine that your computer may need extra time to process data returned from the transceiver, you should send the Pacing command first. Here is an example of the Pacing command setting a 2-ms delay:

```
PRINT #2, CHR$(0);CHR$(0);CHR$(0);CHR$(2);CHR$(&HE);
```

Notice that the instruction opcode is sent last, with the first (MSB) parameter sent just before it, and the LSB parameter (or dummies) sent first. The parameters are sent in the reverse order from that in which they appear in the CAT Commands table. Also note that in this and the following examples, we are sending zeros as dummy bytes; although this is not necessary. If you decide to send commands through a 5-byte array, the values of the dummy parameters need not be cleared.

Using the same example as on page 31, the following command could be used to set the frequency of the display to 14.25000 MHz:

```
PRINT #2, CHR$(&H00); CHR$(&H50);  
CHR$(&H42); CHR$(&H01); CHR$(&HA);
```

Notice here that the BCD values can be sent just by preceding the decimal digits with "&H" in this example. However, in an actual program you may prefer to convert the decimal frequency



variable in the program to an ASCII string, and then to convert the string to characters through a lookup table.

If you send a parameter that is out of range for the intended function, or not among the specified legal values for that function, the FT-890 should do nothing. Therefore, you may wish to alternate your sending regular commands or command groups with a *Read Flags* or an *Update* command, allowing the transceiver to let the computer know if everything sent so far has been accepted and acted upon as expected.

Bear in mind that some commands specify "binary," as opposed to BCD-formatted parameters. You can send binary parameters without going through the character/hex string conversion process. For example, the CH parameter in the Command table is binary. You could have the FT-890 recall memory 29 (decimal) by the following:

```
PRINT #2, CHR$(0);CHR$(0);CHR$(0);CHR$(29);CHR$(2);
```

### Reading Returned Data

The reading process is easily done through a loop, storing incoming data into an array, which can then be processed after all expected bytes have been read into the array. To read the meter:

```
FOR I=1 TO 5
  MDATA(I) = ASC(INPUT$(1,#2))
NEXT I
```

Recall from above that the meter data consists of four identical bytes, followed by a filler byte, so we really only need to see one byte to get all of the information this command offers. Nevertheless, we must read all five bytes (or 1, 18, 19 or 649, in the case of the Update data). After reading all of the data, we can select the bytes of interest to us from the array (MDATA, in the above example).

### CTCSS Tone Codes (hex) & Frequencies (Hz)

Frequency	Code	Frequency	Code
67.0	00	146.2	11h
71.9	01	151.4	12h
77.0	02	156.7	13h
82.5	03	162.2	14h
88.5	04	167.9	15h
94.8	05	173.8	16h
100.0	06	179.9	17h
103.5	07	186.2	18h
107.2	08	192.8	19h
110.9	09	203.5	1Ah
114.8	0Ah	210.7	1Bh
118.8	0Bh	218.1	1Ch
123.0	0Ch	225.7	1Dh
127.3	0Dh	233.6	1Eh
131.8	0Eh	241.8	1Fh
136.5	0Fh	250.3	20h
141.3	10h		

# Installing Internal Accessories

This chapter describes installation of the internal options available for the FT-890. The ATU-2 automatic antenna tuner and the YF-100 or XF-455K-251-01 and YF-101 crystal filters can be installed by removing only the bottom cover, while installing the TCXO-3 master oscillator requires removing first the bottom cover and then the top cover/heatsink. This chapter describes the cover removal procedures first, followed by the individual procedures for each option. Proper performance with these options depends on proper installation. If you are unsure of the procedures after reading the following, feel free to ask your Yaesu dealer for help.

## Cover Removal

- Turn the transceiver off, and disconnect all cables.
- Place the set upside-down on the work surface with the rear facing you, and remove the eight screws affixing the bottom cover (Figure 1). Then lift the bottom cover off.

If you are installing only the ATU-2, proceed directly from here to the procedure on page 39.

- Disconnect the light-blue-banded coaxial cable from J2026 near the rear of the exposed RF Unit (#1 in Figure 2). If you are not installing any crystal filters, skip the next three steps.
- If installing crystal filters you will need to access the solder side of the RF Unit. Unplug the yellow-banded coaxial cable from J2024 near the rear corner of the RF Unit (#2 in Figure 2).
- Using a small sharp tool, gently pry up on either side of J2011, the white plastic ribbon cable socket near the rear left corner of the RF Unit (#3 in Figure 2), about 2 mm ( $\frac{1}{8}$  inch), until the ribbon cable can be removed (see Figure 3).
- Remove the six screws indicated in Figure 2 (one is inside the large shield housing, accessible through the hole near the corner).
- If not installing the TCXO-3, the crystal filters can now be installed as described on page 39. Otherwise, continue with the following steps:

## TCXO-3 Enhanced-Stability Oscillator

The  $\pm 2$ -ppm TXCO-3 option can be installed as a replacement for the standard  $\pm 10$ -ppm crystal oscillator.

Figure 1: Bottom Cover Removal



Figure 2: RF Unit Location

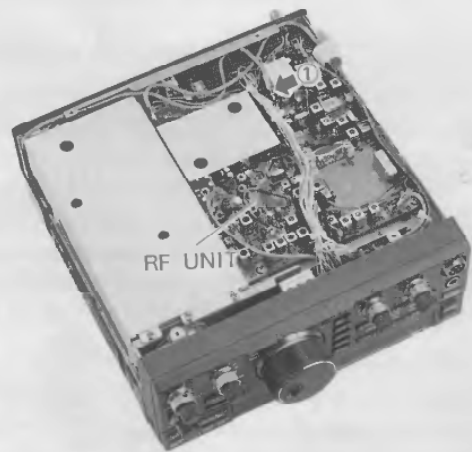
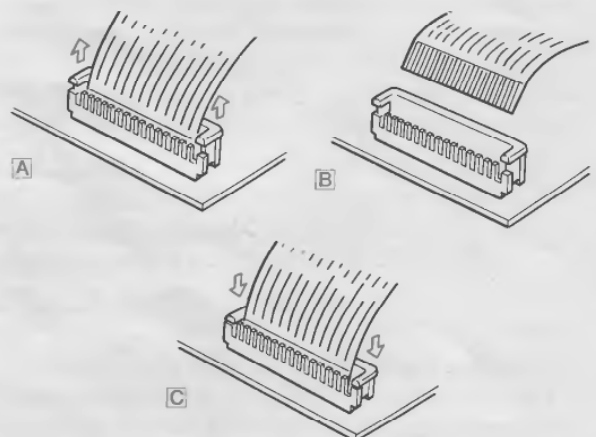

Figure 3: Ribbon Cable Connector



**Fig. 4: Top Cover/Heatsink Removal**



**Figure 5: Local Unit Shield Cover**

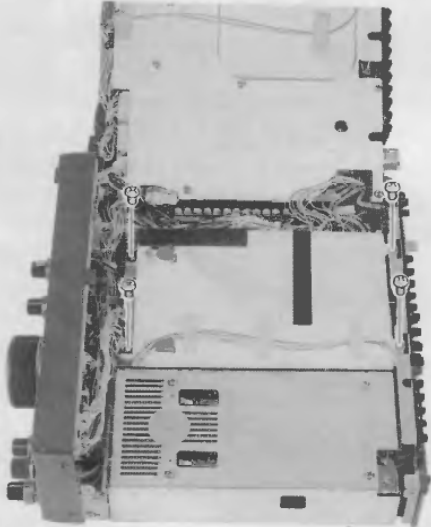

**Figure 6: Local Unit Connectors**

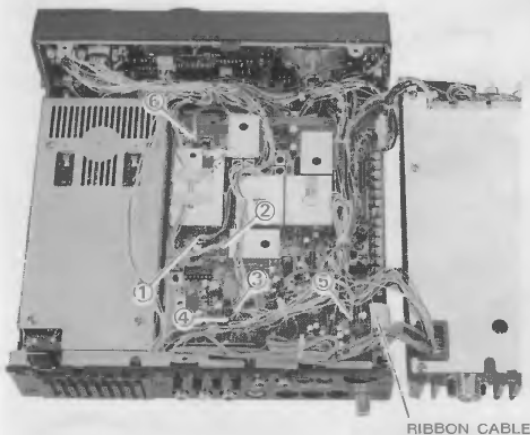

RIBBON CABLE

- Place the transceiver topside-up so that the rear panel is facing you, and remove the four screws indicated in Figure 4.
- Now turn the transceiver onto its right side (as viewed from the rear). Lift the rear of the top cover/heatsink about 2 cm (3/4 inch), then slide it back slightly and begin to fold away the uppermost side. Using care to unhook the coaxial cable that was disconnected above from the RF Unit, fold the two halves of the chassis apart until they lay flat, side by side.
- Remove the four screws affixing the shield cover over the Local Unit (Figure 5). Then remove the tape (3 places) holding the cable to the shield cover, and remove the shield.
- To access the solder side of the Local Unit, first remove the tape holding the wire harness to the top of the VCO housing (with 4 holes in it — see Figure 6). Then disconnect the connectors at points 1 through 6, and the ribbon cable at point A, by gently prying up each side of the connector as shown in Figure 3.
- Remove the seven screws shown in Figure 7 (note that one is next to the DVS-2 jack on the rear panel), and also remove the upper one of the two screws on either side of the front panel (Figure 8, next page), and loosen the lower one (on each side), allowing the front panel to be folded forward so that the Local Unit can be lifted as shown in Figure 9 (next page).
- Referring to Figure 9, locate capacitor C1323 and resistor R1361 on the board just behind the oscillator housing. Cut the leads of these parts and remove them.
- Straighten the leads on the TCXO-3 module, if necessary. Then position it so that the trimmer

**Figure 7: Local Unit Screws**

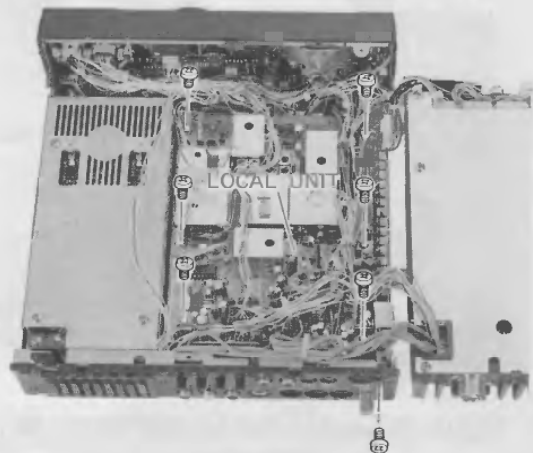

hole is oriented as shown in Figure 10 (the label should be upside-down when viewed from the rear), and push the module leads through the board. Hold the module snug against the board while soldering it in place on the other side.

- Replace the Local Unit board in the chassis, using care to make sure no wires are pinched. Reconnect the cables removed from the board, according to Figure 6 and the pin 1 wire color codes in the table below, before replacing the six screws in the board and one in the rear panel (Figure 7), and the two on each side of the front panel (Figure 8). Also replace the tape on the top of the VCO housing.
- Again making sure no wires are pinched, replace the Local Unit shield cover and its four screws (Figure 5).

Location # in Fig 6	Connector	Pins	Pin 1 Wire Color
1	J1012	4	Green
2	J1010	5	Violet
3	J1027	5	Blue
4	J1005	5	Yellow
5	J1033	4	Blue
6	J1001	Coax	Red Band

**Local Unit Connector Color Codes**

**Figure 8: Front Panel Screws (side)**

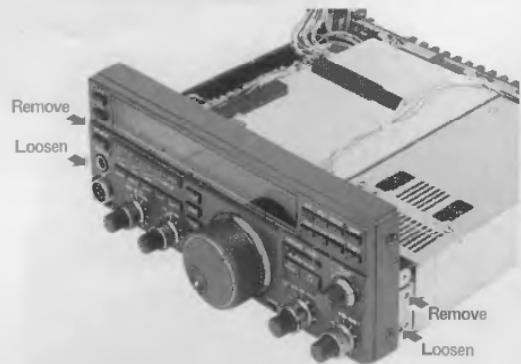

- Replace the top cover/heatsink by routing the light-blue-banded cable around the rear left corner of the chassis (as viewed from the rear), and then after making sure no wires are pinched, replace the four screws shown in Figure 4. The two on top have washers.
- Turn the set over, and, unless installing other options, reconnect the light-blue-banded cable to J2026 and replace the bottom cover (bail towards the front) and its eight screws.

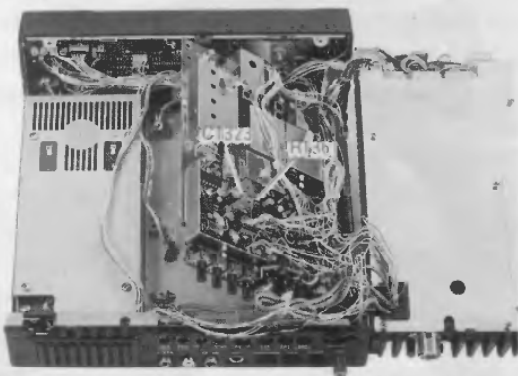

**Figure 9: Local Unit Components to Remove**

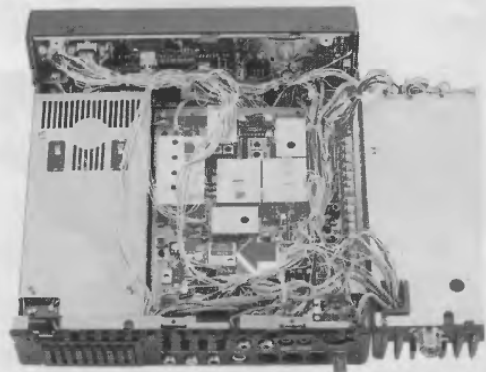

**Figure 10: TCXO-3 Orientation**

### Optional IF Crystal Filters

The 500-Hz YF-100 or 250-Hz XF-455K-251-01 crystal filters may be installed for CW narrow reception, and the YF-101 2.6-kHz crystal filter may be installed for improved SSB and AM narrow receiver selectivity.

- If you haven't already, perform the first six steps under *Cover Removal* at the start of this chapter.
- Referring to the photos at the right, determine the location(s) of the filter(s) you are installing (the YF-100 and XF-455K-251-01 cannot both be installed, as they use the same mounting location). If installing either filter for CW narrow, remove the jumper plug indicated in the upper photo at the right.
- If installing the YF-101 for SSB and AM narrow, lift the rear edge of the board and carefully unsolder and remove the ceramic filter.
- Straighten the new filters' leads, if necessary. Then position each filter as indicated in the photos, and push the filter leads through the board.
- Lift the rear edge of the board and solder each filter lead on the solder side of the board while holding the filter snug against the board. Then clip off any excess leads. Check your solder joints carefully.
- Replace the board in the chassis, using care to avoid pinching any wires.
- Replace the six screws removed from the RF Unit (Figure 2), and replace the coaxial cables (#1 and #2 in Figure 2): the yellow-banded cable goes in J2024, and the light-blue-banded cable goes in J2026.
- Referring to Figure 3C, replace the ribbon cable into its connector, and press down firmly on both sides of the socket while pressing the ribbon cable into the socket. Confirm that it is firmly in place.
- Unless installing the ATU-2, replace the bottom cover (bail towards the front) and its eight screws.

### ATU-2 Internal Antenna Tuner

- If you haven't already, perform the first two steps under *Cover Removal* at the start of this chapter.
- Locate the two unconnected coaxial cables and three unused plastic connectors in the space on the right side of the chassis (when viewed from the rear).

### CW Filter, Jumper & Ceramic SSB Filter



### SSB Filter Location (replacing Ceramic Filter)



### ATU-2 Connectors



## Installing Internal Accessories

- Position the ATU-2 so that the tab with the two mounting holes is toward the front of the transceiver, nearest the upward-facing bottom edge of the front panel.
- Connect the unused cables to the sockets on the rear of the ATU-2. The green-banded coax goes to J6502, the red-banded coax to J6510, and the 4-, 5- and 6-pin connectors to J6504, J6505 and J6506, respectively.
- Position the ATU-2 in the chassis, and mount it in place with the three supplied screws.
- If you installed the TCXO-3 but no crystal filters, replace the light-blue-banded coax into J2026 on the RF Unit.
- Replace the bottom cover (with the bail towards the front) and its eight screws.

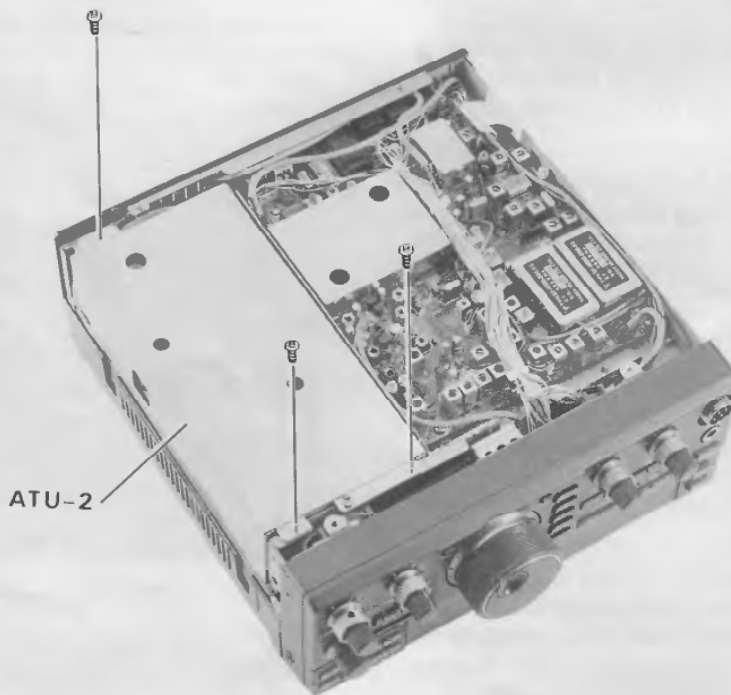

ATU-2 Mounting

# Rear Panel

**Note:** The only required connections for operating the transceiver are DC power (below) and an antenna. Also, a proper ground is highly recommended, and may be necessary for proper operation. All other rear panel connections are optional.

This is the 13.5-volt DC power connector. Connect a 20-A supply as shown below. See also the Caution on page 6.

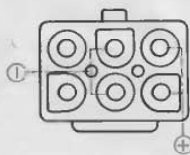

This grill is the air inlet for the cooling system. Make sure nothing blocks this grill in your installation, as cool air must be free to enter here for proper cooling.

This red phono jack provides 13.5-V DC (pin positive) at up to 200 mA for powering an external accessory.

**CAUTION! The line is not fused, so be careful not to reverse polarity or draw more than 200 mA, as serious damage can result!**

This yellow phono control input jack can be used to activate the transmitter remotely (by shorting the contacts). Open circuit voltage is 13.5 V, and closed circuit current is 15 mA.

Use these three controls to set up VOX (voice-actuated transmit/receive switching) operation as described on page 19. The **DELAY** control also serves to set CW semi-break-in timing, as described on page 20.

Use this control to adjust speech processor compression as described on page 18.

This phono jack accepts transmitter audio input from a phone patch to be mixed with the microphone audio (see page 28). Input impedance is 500 ~ 1000 ohms, and optimum peak input level is 2 mV<sub>rms</sub>.

This phono jack accepts external ALC (Automatic Level Control) voltage from a linear amplifier, to prevent over-excitation. Power cuts back as voltage becomes more negative than -4-V DC.

Connect the 50-Ω coaxial feedline to your antenna or external ATU here using a type M (JHF, PL-259) plug. **Do not operate the transceiver without an antenna or dummy load!**

This 2-contact mini phone jack provides receiver audio for an external loudspeaker, such as the one provided in the FP-800 PSU, or the SP-6. Inserting a plug in this jack disables the internal loudspeaker. Impedance is 4 to 16 Ω.

This 7-pin input/output jack is for connection of the DVS-2 Digital Voice Recording option, described on page 30.

This 3-contact mini phone jack provides constant-level receiver audio output on the ring contact, and accepts transmit audio input on the tip contact, for use with a packet TNC or other terminal unit. Input level should be 20 ~ 40 mV at 2 ~ 3 kΩ, and output is 30 mV peak at 600 ohms. See page 27).

Connect this terminal to a good earth ground, for safety and optimum performance.

This 5-pin mini DIN jack is for the FC-800 External Automatic Antenna Tuner. Pinout is on page 9.

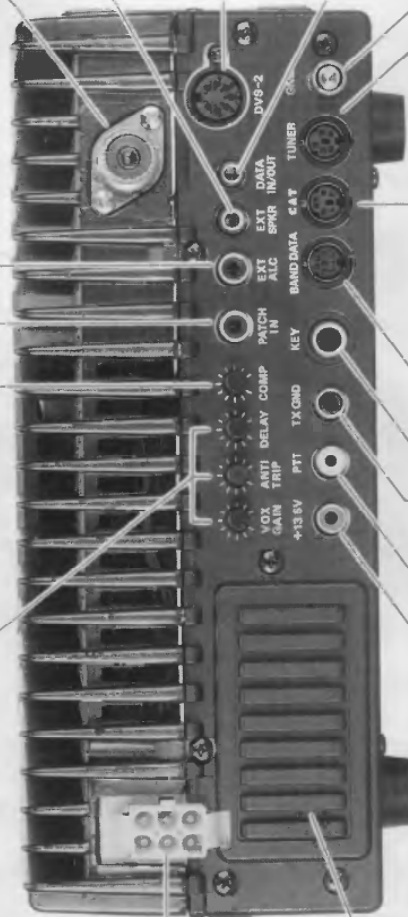

This black phono output jack connects to relay contacts which are closed during transmission, for control of a non-QSK linear amplifier. See page 11.

Connect your CW key, keyer paddles or external keyer to this 1/4-inch 3-contact jack. Wiring is on page 19. Open circuit voltage is +5 V DC, and closed circuit current is 0.7 mA. **Never use a 2-contact plug in this jack!**

This 6-pin mini DIN input/output jack allows external computer control of the FT-890. Signals levels are TTL (0 and 5 V DC). Pinout is on page 9, and the signalling protocol and data formats are described in the CAT chapter, starting on page 31.

This 8-pin jack outputs control signals for the FL-7000 Linear or FC-1000 ATU, including band selection data to set the Linear or Tuner to the same band as the FT-890. Pinout is on page 9, and QSK connections on page 11.



**YAESU MUSEN CO., LTD.**

C.P.O. BOX 1500, TOKYO, JAPAN

**YAESU U.S.A.**

17210 Edwards Rd., Cerritos, California 90701, U.S.A.

**YAESU EUROPE B.V.**

Snipweg 3. 1118AA Schiphol, The Netherlands

Downloaded by   
RadioAmateur.EU