

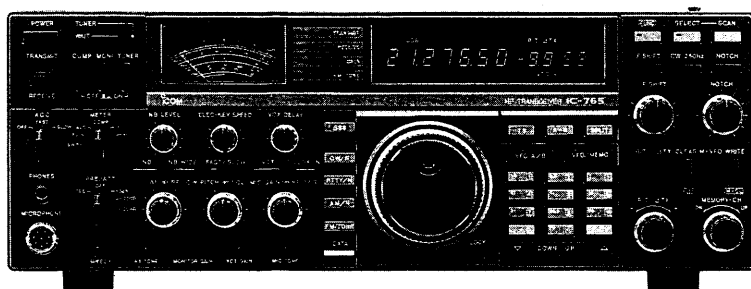

INSTRUCTION MANUAL

HF ALL BAND TRANSCEIVER
IC-765



INTRODUCTION

Thank you for choosing this new Icom product.

Icom's advanced new **IC-765** is designed to meet the increasing demand of today's amateur radio operators for high precision, sophisticated radio communications. Serious HF CW enthusiasts will especially enjoy the multi-function capability of this state-of-the-art rig.

EXPLICIT DEFINITIONS

The following explicit definitions apply to this instruction manual.

WORD	DEFINITION
WARNING	Personal injury, fire hazard or electric shock may occur.
CAUTION	Equipment damage may occur.
NOTE	If disregarded, inconvenience only. No personal injury, risk of fire or electric shock.

UNPACKING

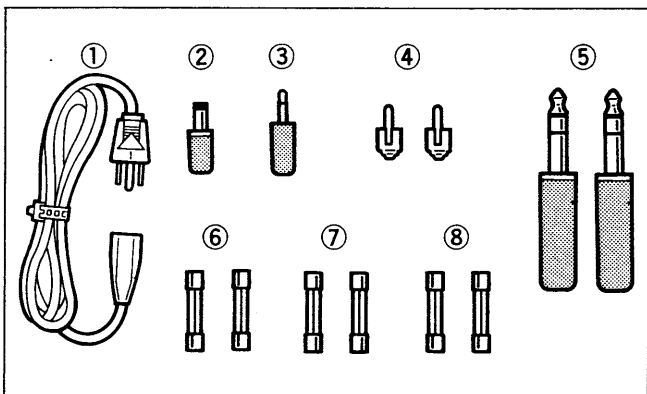

Accessories included with the IC-765:

	Qty.
① AC power cable.	1
② Mini DC power plug.	1
③ External speaker plug.	1
④ Pin plugs (RCA plugs)	2
⑤ 1/4 inch 3 conductor plug.	2
⑥ Spare fuses (for AC line; see below)	2
⑦ Spare fuses (for DC line; 2 A)	2
⑧ Spare fuses (for internal circuitry; 5 A)	2
120 V AC type : 10 A	
220 ~ 240 V AC type : 5 A	

IMPORTANT

- READ THIS INSTRUCTION MANUAL CAREFULLY** before attempting operation. If you have any questions regarding the operation of the IC-765, feel free to contact your nearest authorized Icom Dealer or Service Center.
- SAVE THIS INSTRUCTION MANUAL** — This instruction manual contains important safety and operating instructions for the IC-765.

PRECAUTIONS

- Unplug the AC power cable from the AC outlet and wait a few minutes, then remove the transceiver cover.
- NEVER** let metal, wire or other objects touch any internal part of the transceiver. Risk of electric shock could occur.
- NEVER** place the transceiver within the reach of babies or children at any time.
- NEVER** expose the transceiver to rain, snow or any liquid.
- DO NOT** operate the transceiver when it is covered by objects which impede heat dispersal.
- AVOID** using the transceiver in temperatures below -10°C ($+14^{\circ}\text{F}$) or over $+60^{\circ}\text{C}$ ($+140^{\circ}\text{F}$). The transceiver may not function properly in extreme temperatures.
- AVOID** using the transceiver in excessively dusty environments.
- AVOID** placing the transceiver in direct sunlight.
- BE CAREFUL!** The heatsink may become hot when operating the transceiver continuously for long periods.
- During maritime mobile operations, keep interconnection cables as far away as possible from electronic instruments. This will prevent instrument malfunctions.

- **COMPLETE HF TRANSCEIVER**

Icom's new IC-765 is an advanced HF all band transceiver with a modern heavy-duty design for the serious HF enthusiast. The IC-765 features a 10 Hz digit in the display, a high speed PLL lock-up time including Icom's exclusive DDS circuit, a newly developed fully automatic antenna tuner, and many more advanced features.

- **FULLY AUTOMATIC HIGH SPEED ANTENNA TUNER**

The built-in CPU memorizes previously matched conditions on each band. Tuning speed is ultra fast since tuning starts from a previous position. If the antenna tuner cannot tune from a previously memorized preset position, the advanced re-try function automatically changes the preset position and memorizes the best preset position.

- **COMPLETE SYSTEM FOR CW OPERATORS**

The IC-765 has high-speed CW full break-in capability and many comfortable functions such as a electronic keyer, independent iambic key jack, keying speed control and CW pitch control. The IC-765 includes a 500 Hz CW narrow filter for effectively removing QRM on crowded bands.

- **10 Hz DIGIT DISPLAY**

The large fluorescent display shows 7 digits for the operating frequency, meaning that the 10 Hz digit is also displayed.

- **BAND STACKING REGISTER**

Each band memorizes the last used frequency, mode, and IF filter condition (narrow or normal). The feature gives the IC-765 a simulation of 18 VFO capability (2 VFOs for each band).

- **105 dB DYNAMIC RANGE**

Receiver ability is fixed by the dynamic range. The Icom DFM (Direct Feed Mixer) system provides an excellent 105 dB dynamic range.

- **NEW PLL CIRCUIT-ADOPTED DDS**

The advanced Icom DDS (Direct Digital Synthesizer) System ensures high speed PLL lock-up times, clear signal emissions, and high C/N characteristics. A high-speed PLL provides very fast CW full break-in performances.

- **OTHER CONVENIENT FEATURES**

- 10 dB preamp
- Selectable attenuator, 10, 20, 30 dB
- 99-channel memory
- Split memory on channels 90 ~ 99
- Built-in 500 Hz CW narrow filter
- Programmed scan, memory scan and selected memory scan
- Separate LED lights on a selected memory channel
- IF shift
- Notch filter
- Low distortion 100 W power amplifier
- Large heatsink and cooling fan
- Fast/Slow/OFF selectable AGC
- RF-type speech compressor
- New-type noise blanker
- DATA switch for advanced data communications
- CI-V bus line

■ FRONT PANEL (See pgs. 3 ~ 8)

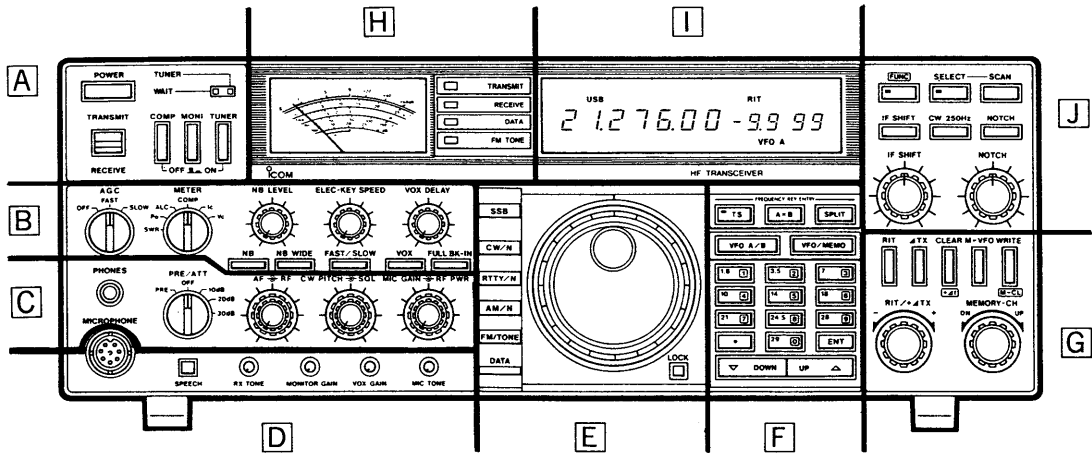

■ HATCH COVER (See p. 9)

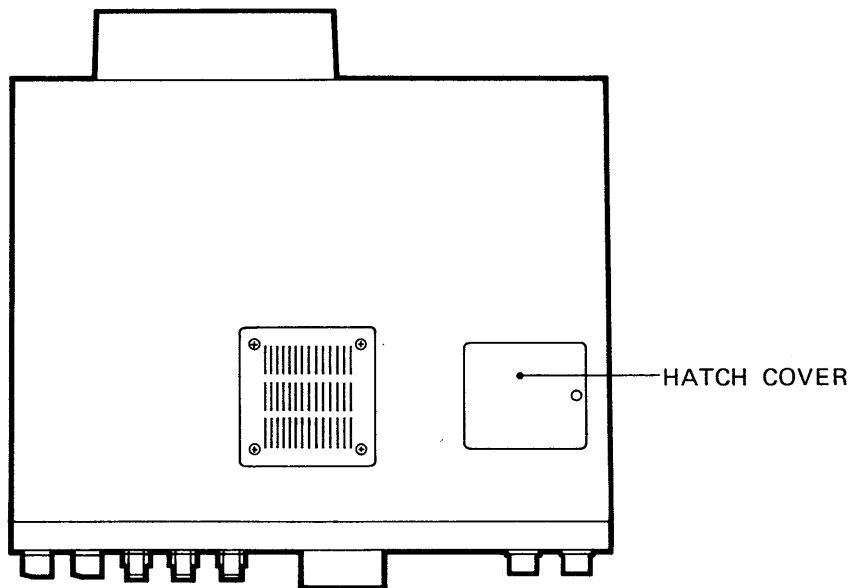

■ REAR PANEL (See p. 10)

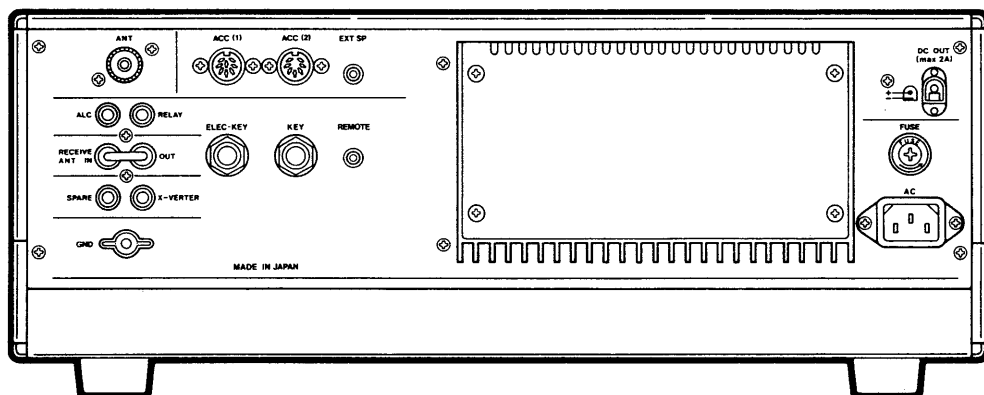

2 CONTROL FUNCTIONS

2-1 FRONT PANEL

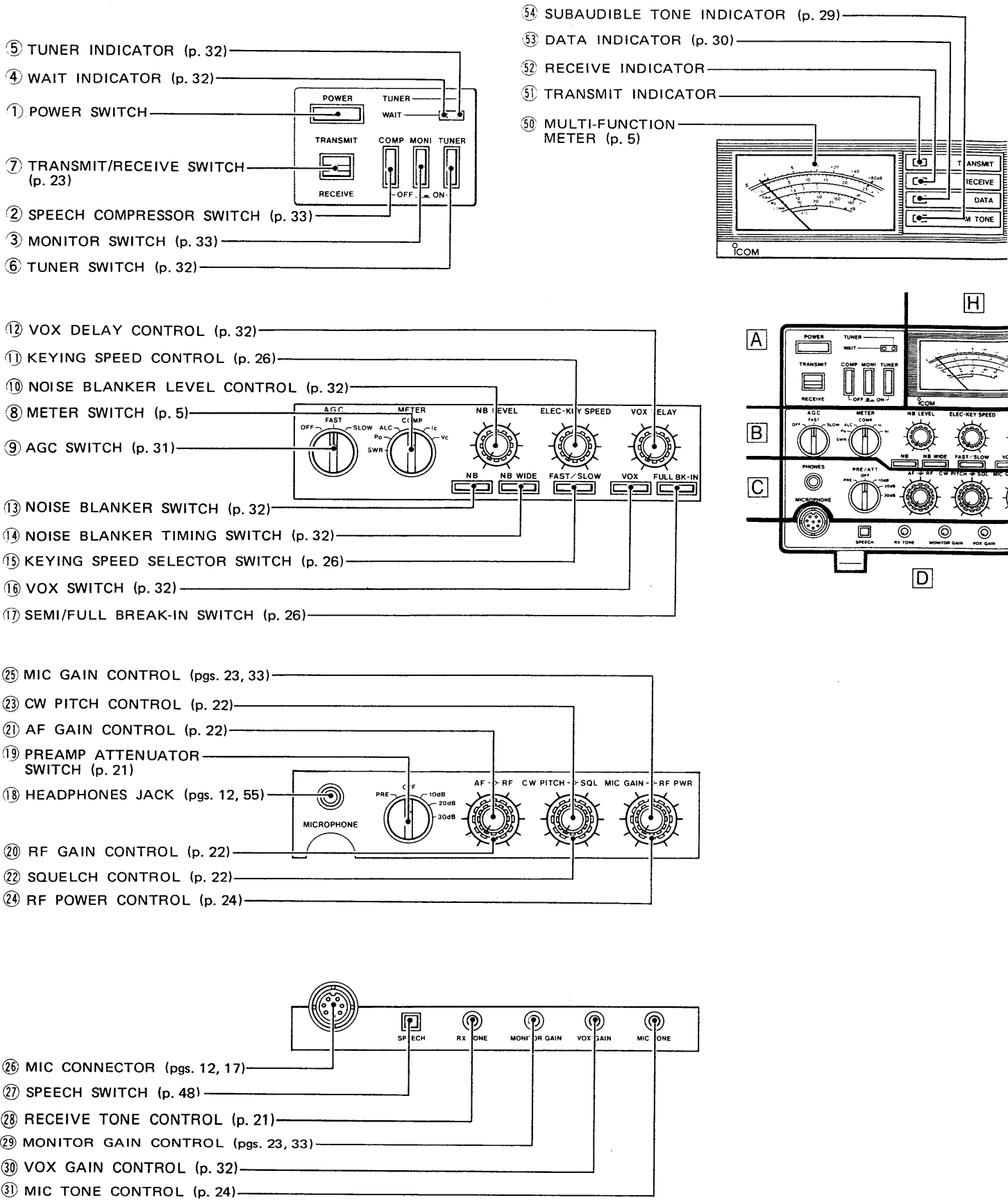

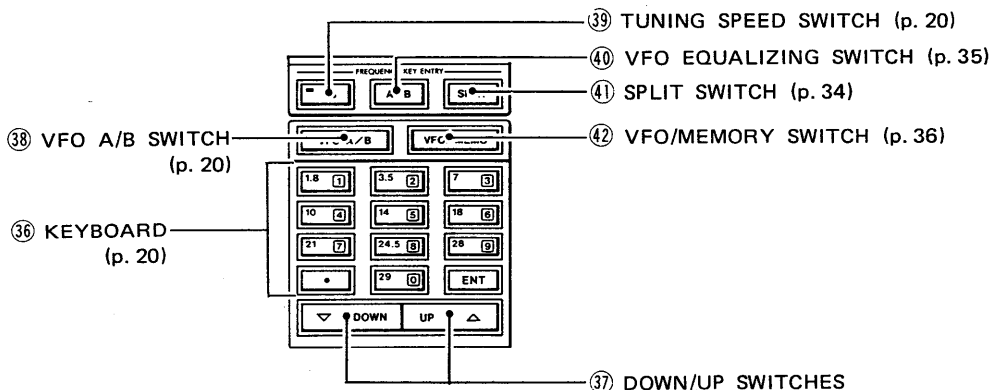
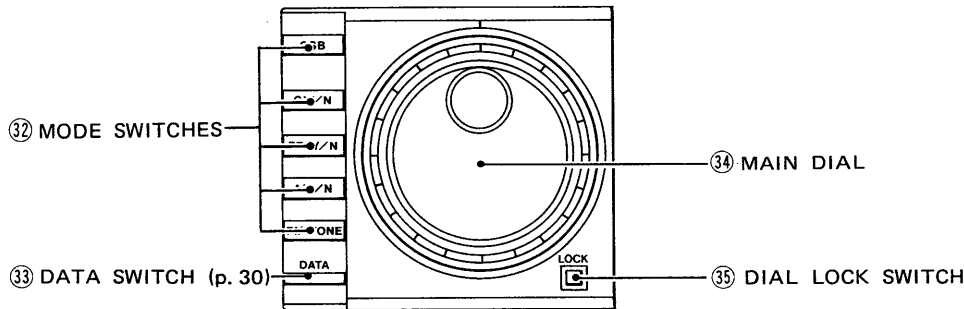
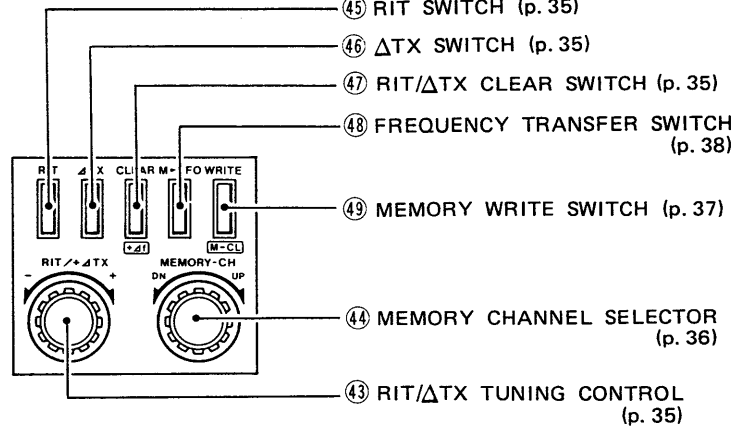
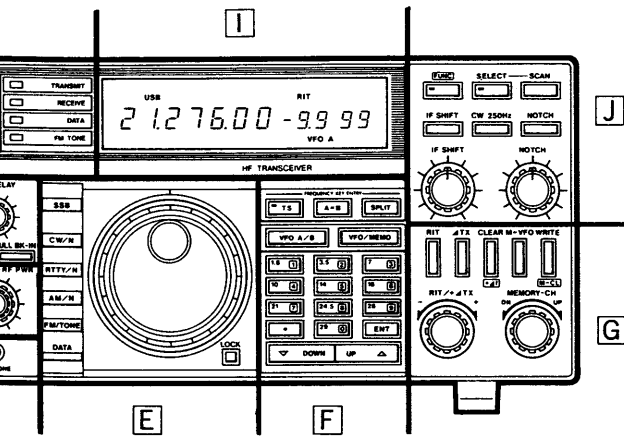
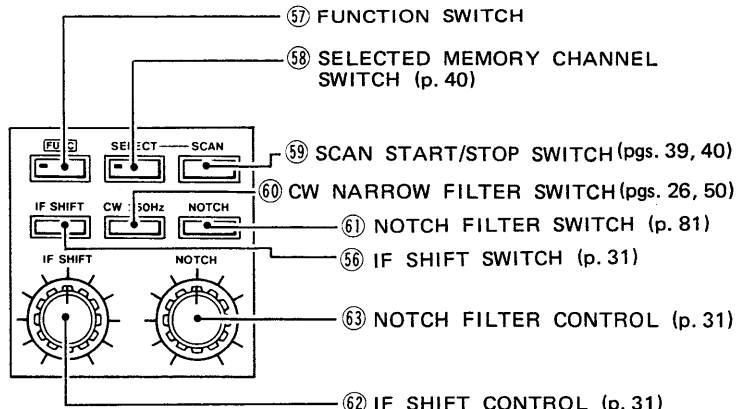
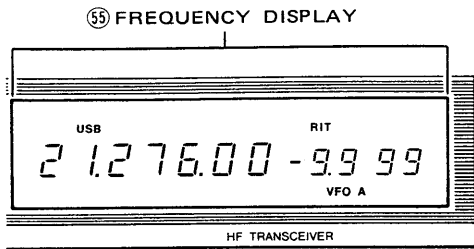

2 CONTROL FUNCTIONS

A B

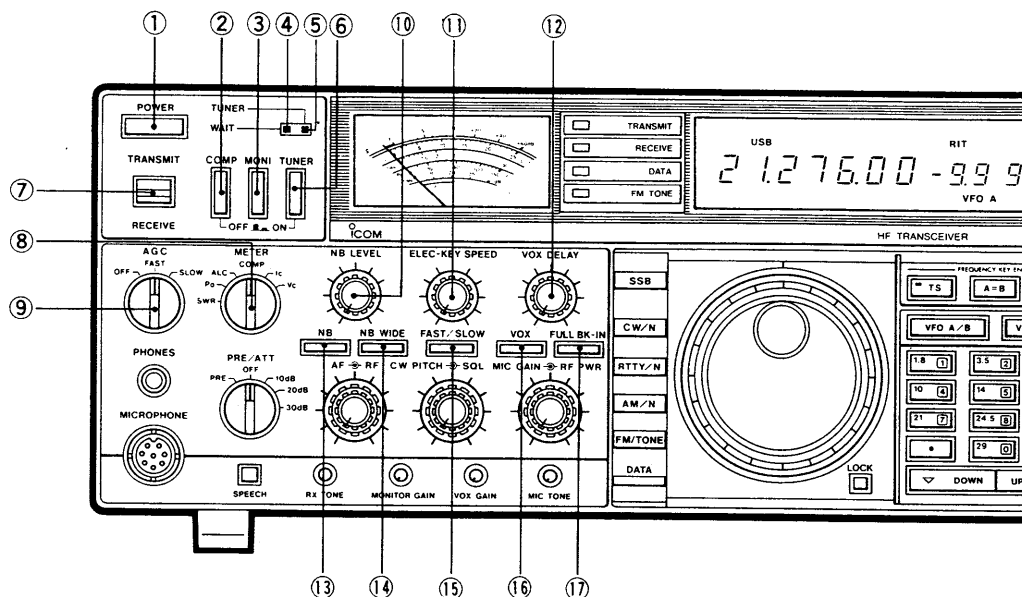

- ① **POWER SWITCH [POWER]**
Turns the power ON and OFF.
- ② **SPEECH COMPRESSOR SWITCH [COMP]** (p. 33)
Activates the built-in speech compressor.
- ③ **MONITOR SWITCH [MONI]** (p. 33)
Activates the monitor function.
- ④ **WAIT INDICATOR [WAIT]** (p. 32)
Lights when the built-in antenna tuner is being tuned.
- ⑤ **TUNER INDICATOR [TUNER]** (p. 32)
Lights when the built-in antenna tuner is turned ON.
- ⑥ **TUNER SWITCH [TUNER]** (p. 32)
Activates the built-in antenna tuner.
- ⑦ **TRANSMIT/RECEIVE SWITCH [TRANSMIT/RECEIVE]** (p. 23)
Selects transmit or receive.
- ⑧ **METER SWITCH [METER]**
Selects the following switch positions:

SWITCH POSITION	MEASUREMENT
[SWR]	Indicates the SWR over the transmission line.
[Po]	Indicates the relative RF output power in watts.
[ALC]	Indicates the ALC level. The ALC circuit begins to activate when the RF output power reaches a preset level.
[COMP]	Indicates the compression level when the speech compressor is in use.
[Ic]	Indicates the collector current of the final transistors.
[Vc]	Indicates the collector voltage of the final transistors.
- ⑨ **AGC SWITCH [AGC]** (p. 31)
Changes the time constant of the AGC circuit.
- ⑩ **NOISE BLANKER LEVEL CONTROL [NB LEVEL]** (p. 32)
Adjusts the threshold level of the noise blanker.
- ⑪ **KEYING SPEED CONTROL [ELEC-KEY SPEED]** (p. 26)
Adjusts the keying speed when operating in CW mode with the built-in electronic keyer.
- ⑫ **VOX DELAY CONTROL [VOX DELAY]** (p. 32)
Changes the transmit-to-receive switching time when the VOX function is activated.
- ⑬ **NOISE BLANKER SWITCH [NB]** (p. 32)
Activates the noise blanker circuit.
- ⑭ **NOISE BLANKER TIMING SWITCH [NB WIDE]** (p. 32)
Selects the blanking time of the noise blanker circuit for a normal or wide blank width.
- ⑮ **KEYING SPEED SELECTOR SWITCH [FAST/SLOW]** (p. 26)
Selects the keying speed for slow or fast when operating in CW mode with the built-in electronic keyer.
- ⑯ **VOX SWITCH [VOX]** (p. 32)
Turns the VOX function ON and OFF.
- ⑰ **SEMI/FULL BREAK-IN SWITCH [FULL BK-IN]** (p. 26)
Selects semi or full break-in operation for CW operating purposes.

C D E

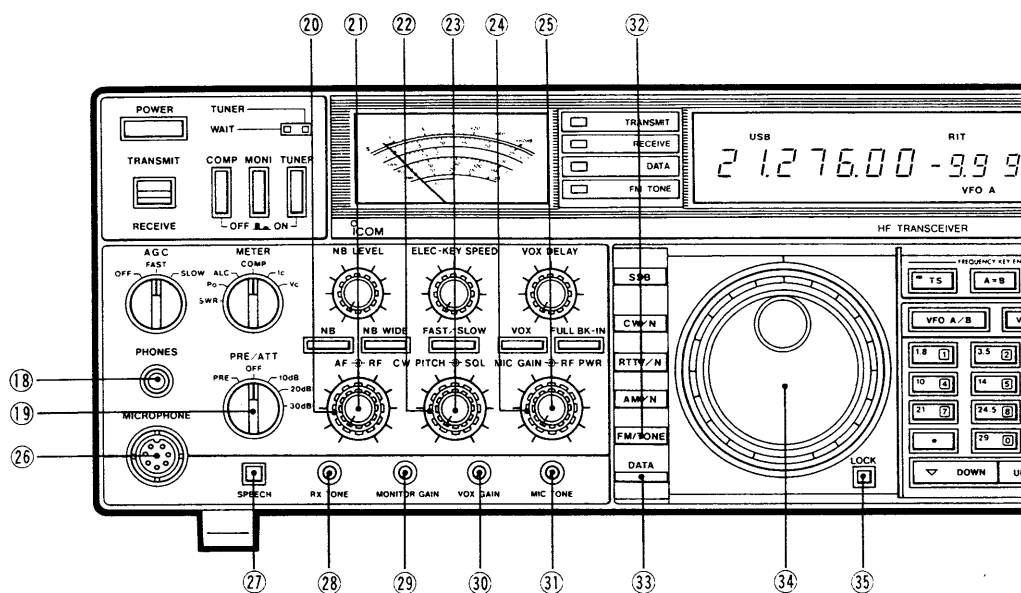

- ⑱ **HEADPHONES JACK [PHONES]** (pgs. 12, 55)
Accepts a standard 1/4 inch plug from 4 ~ 16 Ω mono or stereo headphones.
- ⑲ **PREAMP/ATTENUATOR SWITCH [PRE/ATT]** (p. 21)
Selects the receive RF preamplifier or an RF attenuator.
- ⑳ **RF GAIN CONTROL [RF]** (p. 22)
Adjusts gain at the receiver RF stage.
- ㉑ **AF GAIN CONTROL [AF]** (p. 22)
Adjusts audio output level.
- ㉒ **SQUELCH CONTROL [SQL]** (p. 22)
Adjusts the squelch threshold level.
- ㉓ **CW PITCH CONTROL [CW PITCH]** (p. 22)
Adjusts the receiver or monitored CW audio tone without changing the displayed frequency.
- ㉔ **RF POWER CONTROL [RF PWR]** (p. 24)
Adjusts RF output power.
- ㉕ **MIC GAIN CONTROL [MIC GAIN]** (pgs. 23, 33)
Adjusts microphone input gain.
- ㉖ **MIC CONNECTOR** (pgs. 12, 17)
Accepts optional microphone described on p. 55.
- ㉗ **SPEECH SWITCH [SPEECH]** (p. 48)
Activates the UT-36 VOICE SYNTHESIZER UNIT (optional) for announcing the displayed frequency and mode in English.
- ㉘ **RECEIVE TONE CONTROL [RX TONE]** (p. 21)
Adjusts the receive audio response.
- ㉙ **MONITOR GAIN CONTROL [MONITOR GAIN]** (pgs. 23, 33)
Adjusts the monitor output level when the [MONI] switch is turned ON.
- ㉚ **VOX GAIN CONTROL [VOX GAIN]** (p. 32)
Adjusts the VOX circuit sensitivity.
- ㉛ **MIC TONE CONTROL [MIC TONE]** (p. 24)
Adjusts the transmit audio response.
- ㉜ **MODE SWITCHES**
Selects the desired operating mode.
- ㉝ **DATA SWITCH [DATA]** (p. 30)
Inhibits microphone input except when the microphone PTT switch is pushed. The switch is also used for operating data communications such as packet or AMTOR.
- ㉞ **MAIN DIAL**
Changes the operating frequency.
- ㉟ **DIAL LOCK SWITCH [LOCK]**
Deactivates the main dial and electronically locks the currently displayed frequency.

2 CONTROL FUNCTIONS

F G H

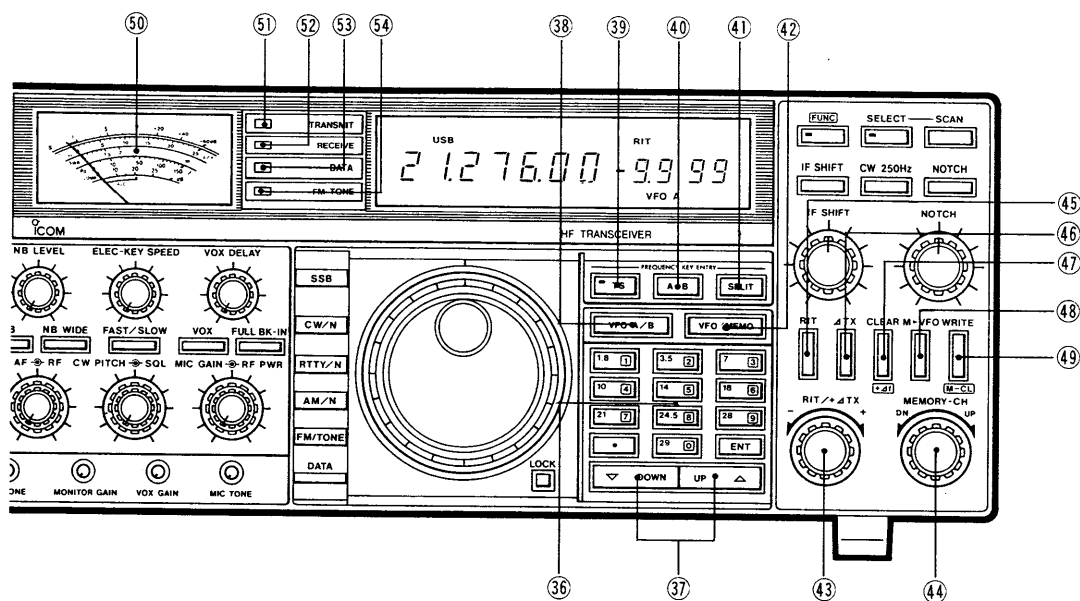

- ③⑥ **KEYBOARD** [p. 20]
Sets the operating band or frequency.
- ③⑦ **DOWN/UP SWITCHES** [DOWN], [UP]
Changes the operating frequency in 1 MHz steps.
- ③⑧ **VFO A/B SWITCH** [VFO A/B] (p. 20)
Selects VFO A or VFO B for tuning purposes.
- ③⑨ **TUNING SPEED SWITCH** [TS] (p. 20)
Changes the tuning rate to 1 kHz while in any operating mode.
- ④⑩ **VFO EQUALIZING SWITCH** [A=B] (p. 35)
Equalizes the frequency and mode of the two VFOs.
- ④① **SPLIT SWITCH** [SPLIT] (p. 34)
Selects split operation.
- ④② **VFO/MEMO SWITCH** [VFO/MEMO] (p. 36)
Selects VFO or MEMORY mode.
- ④③ **RIT/ Δ TX TUNING CONTROL** [RIT/ Δ TX] (p. 35)
Shifts the receive or transmit frequency by up to ± 9.99 kHz independently when the RIT or Δ TX function is activated.
- ④④ **MEMORY CHANNEL SELECTOR** [MEMORY-CH] (p. 36)
Selects the desired memory channel.
- ④⑤ **RIT SWITCH** [RIT] (p. 35)
Activates the RIT (receiver incremental tuning) function.
- ④⑥ **Δ TX SWITCH** [Δ TX] (p. 35)
Activates the variable transmit frequency function.
- ④⑦ **RIT/ Δ TX CLEAR SWITCH** [CLEAR] (p. 35)
Clears the frequency shift information set with the [RIT/ Δ TX] control.
- ④⑧ **FREQUENCY TRANSFER SWITCH** [M \blacktriangleright VFO] (p. 38)
Activates the frequency transfer function.
- ④⑨ **MEMORY WRITE SWITCH** [WRITE] (p. 37)
Stores the displayed frequency and mode into the displayed memory channel.
- ⑤⑩ **MULTI-FUNCTION METER**
Acts as an S-meter (signal strength meter) in receive mode. For transmitter meter readings, see item ⑧.
- ⑤① **TRANSMIT INDICATOR** [TRANSMIT]
Lights when the transceiver is in transmit mode.
- ⑤② **RECEIVE INDICATOR** [RECEIVE]
Lights when the transceiver is in receive mode and the squelch is open.
- ⑤③ **DATA INDICATOR** [DATA] (p. 30)
Lights when the [DATA] switch is pushed.
- ⑤④ **SUBAUDIBLE TONE INDICATOR** [FM TONE] (p. 29)
Lights when a subaudible tone circuit is turned ON in FM mode.

I J

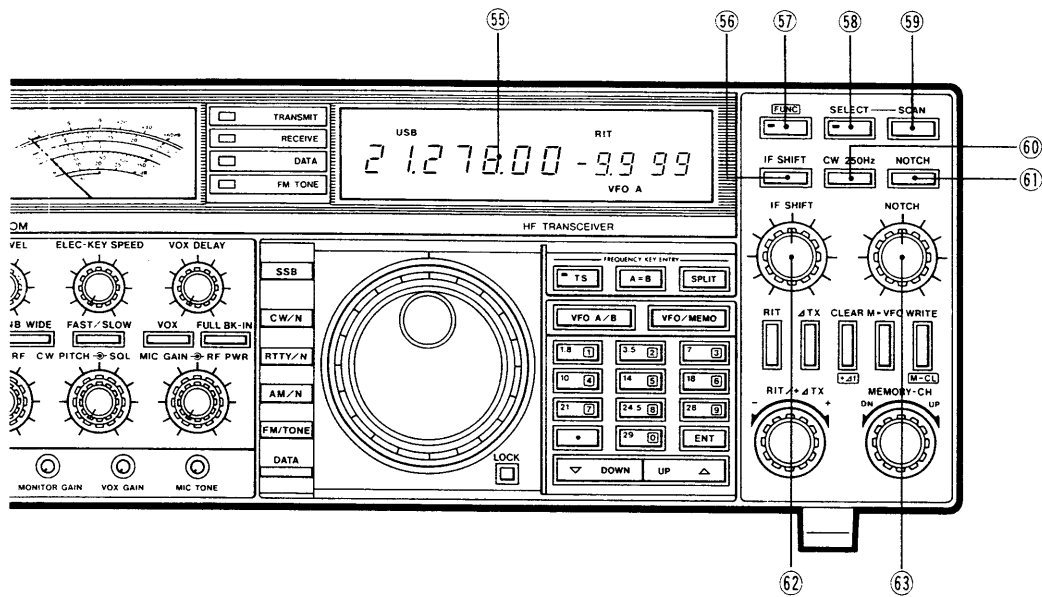

55 FREQUENCY DISPLAY

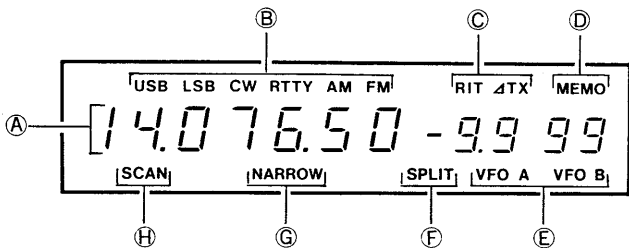

- A FREQUENCY READOUT**
Displays the operating frequency.
- B MODE INDICATORS**
Indicates the operating mode.
- C SHIFT FREQUENCY INDICATORS**
Lights when the RIT or ΔTX function is turned ON and shows the shift frequency up to ±9.9 kHz.
- D MEMORY INDICATOR**
Lights when MEMORY mode is selected and shows the selected memory channel number.
- E VFO INDICATORS**
Lights to indicate which VFO is currently selected.
- F SPLIT INDICATOR**
Lights when split operation is selected.
- G NARROW FILTER INDICATOR**
Lights when the narrow CW, narrow AM or narrow RTTY is selected.
- H SCAN INDICATOR**
Lights when scan is operating.

56 IF SHIFT SWITCH [IF SHIFT] (p. 31)

Activates the IF shift function to reduce interference from adjacent frequency signals.

57 FUNCTION SWITCH [FUNC]

Activates the secondary switch functions.

SWITCH	FUNCTION
[FUNC] + numeral keys	Enters Direct entry mode for setting the desired frequency.
[FUNC] + [CLEAR]	Adds the shift frequency to the displayed frequency.
[FUNC] + [WRITE]	Clears the displayed memory information.

58 SELECTED MEMORY CHANNEL SWITCH [SELECT] (p. 40)

Activates the selected memory channel function.

59 SCAN START/STOP SWITCH [SCAN] (pgs. 39, 40)

Starts and stops a scan.

60 CW NARROW FILTER SWITCH [CW 250Hz] (pgs. 26, 50)

Selects 250 Hz CW narrow filter (optional) in CW mode.

61 NOTCH FILTER SWITCH [NOTCH] (p. 31)

Activates the notch filter function to reduce interference.

62 IF SHIFT CONTROL [IF SHIFT] (p. 31)

Shifts the IF frequency when the [IF SHIFT] switch is pushed IN.

63 NOTCH FILTER CONTROL [NOTCH] (p. 31)

Shifts the notch filter frequency.

2-2 HATCH COVER

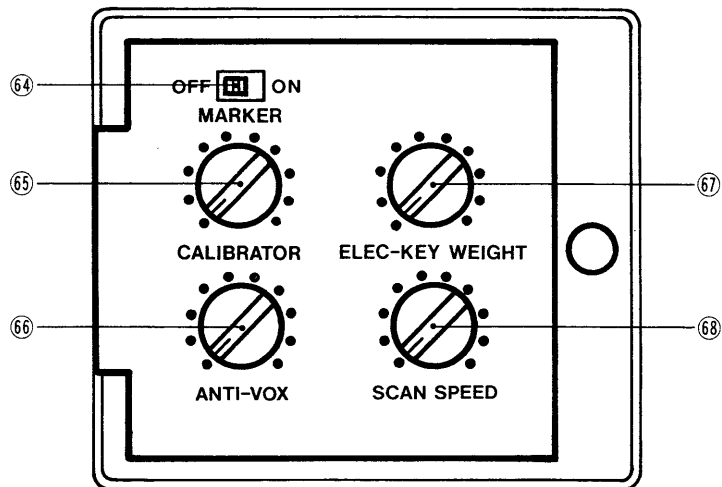

⑥4 **MARKER SWITCH [MARKER]** (p. 45)
Generates calibration markers every 100 kHz.

⑥5 **MARKER CALIBRATOR CONTROL [CALIBRATOR]**
(p. 45)
Adjusts the reference oscillator frequency.

⑥6 **ANTI-VOX CONTROL [ANTI-VOX]** (p. 32)
Adjusts the VOX circuit cut off to prevent tripping the speaker.

⑥7 **ELECTRONIC KEYSER WEIGHT CONTROL [ELEC-KEY WEIGHT]** (p. 45)
Adjusts the keying weight of the electronic keyer.

⑥8 **SCAN SPEED CONTROL [SCAN SPEED]** (p. 46)
Adjusts scan speed.

Tech Talk from Icom

Q. What is the keying weight?

A. The keying weight is the ratio of DOT:SPACE:DASH in CW keying and is especially useful for making personalized CW keying when operating in CW mode with an electronic keyer.

The keying weight is set at the factory for a DOT:SPACE:DASH ratio of 1:1:3. When the control is adjusted, DOTS and DASHES increase in length as shown in the diagram at right.

[EXAMPLE]

Following is the morse code "K".

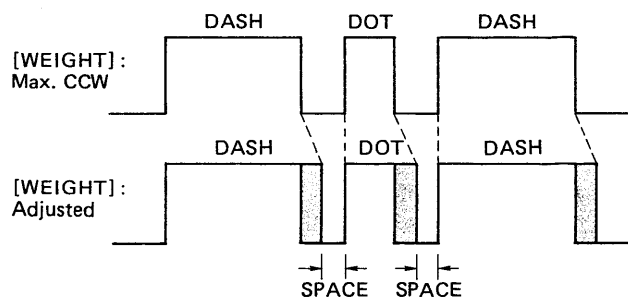

2-3 REAR PANEL

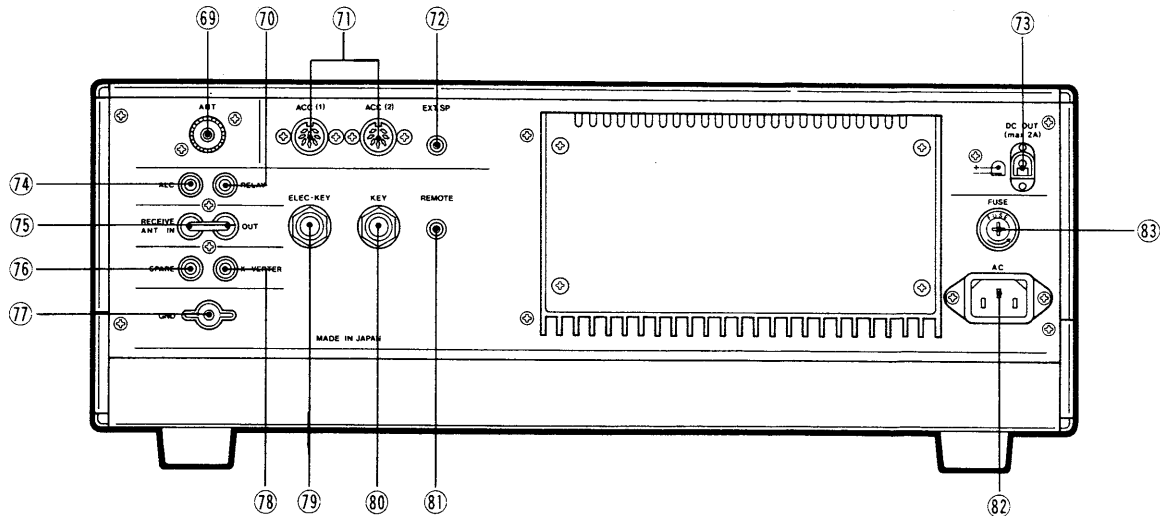

- ⑥9 **ANTENNA CONNECTOR [ANT]** (pgs. 11, 12)
Connects a 50 Ω antenna with a PL-259 plug.
- ⑦0 **T/R CONTROL RELAY JACK [RELAY]** (p. 13)
Connects to the T/R control jack of non-Icom external equipment.
- ⑦1 **ACCESSORY SOCKETS [ACC(1)], [ACC(2)]** (p. 18)
Input and output connections for external equipment.
- ⑦2 **EXTERNAL SPEAKER JACK [EXT SP]** (p. 12)
Connect a 4 ~ 16 Ω speaker, if required.
- ⑦3 **13.8 V DC OUTPUT JACK [DC OUT]** (p. 18)
Outputs 13.8 V DC, 2 A for external equipment.
- ⑦4 **EXTERNAL ALC INPUT JACK [ALC]** (p. 13)
Connects to the ALC output jack of a non-Icom linear amplifier.
- ⑦5 **RECEIVE ANTENNA JACKS [ANT IN], [OUT]** (p. 17)
Located between the transmit/receive switching circuit and the receiver's RF stage.
- ⑦6 **SPARE JACK [SPARE]**
No connection.
- ⑦7 **GROUND TERMINAL [GND]** (p. 11)
To prevent electrical shocks, TVI, BCI and other problems, connect this terminal to ground.
- ⑦8 **TRANSVERTER OUTPUT JACK [X-VERTER]** (p. 17)
Used for operating with an external transverter.
- ⑦9 **ELECTRONIC KEYS JACK [ELEC-KEY]** (p. 17)
Accepts an iambic keyer paddle with a standard 1/4 inch 3-conductor plug (supplied). It does not accept the output of an external electronic keyer.
- ⑧0 **STRAIGHT KEY JACK [KEY]** (p. 17)
Accepts a straight key with standard 1/4 inch plug.
- ⑧1 **CI-V REMOTE CONTROL JACK [REMOTE]** (p. 16)
Designed for use with a personal computer for remote control operation of transceiver functions.
- ⑧2 **AC POWER SOCKET [AC]**
Connects the supplied AC power cable to an AC outlet.
- ⑧3 **FUSE HOLDER [FUSE]**
Holds the following fuses for the internal AC power supply.
 - 120 V AC type : 10 A
 - 220 ~ 240 V AC type : 5 A

3-1 UNPACKING

After unpacking, immediately describe any damage to the delivering carrier or dealer. Keep the shipping cartons. For a description and a diagram of accessory equipment included with the IC-765, see UNPACKING on the inside front cover.

Contact your nearest authorized Icom Dealer or Service Center if you require additional accessory equipment for your IC-765.

3-2 TRANSCEIVER LOCATION

Select a location for the transceiver that allows good ventilation and access to the front and rear panels. Keep away from extreme heat, cold, vibrations, TV sets, TV antenna elements, radios and electro-magnetic sources.

•ADJUSTABLE ANGLES

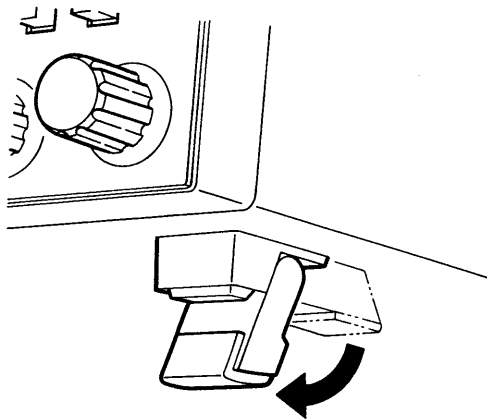

The rubber stands on the bottom of the IC-765 give the transceiver two selectable angles.

3-3 ANTENNA

Select an antenna, such as a well-matched 50 Ω antenna and feedline. The transmission line should be a coaxial cable. VSWR should be less than 3:1.

CAUTION: Protect your transceiver from lightning by using a lightning arrestor.

3-4 GROUNDING

To prevent electrical shocks, TVI, BCI and other problems, ground the transceiver through the GROUND terminal on the rear panel.

For best results, connect a heavy gauge wire or strap to a long earth-sunk copper rod. Make the distance between the GROUND terminal and ground as short as possible.

•GROUNDING

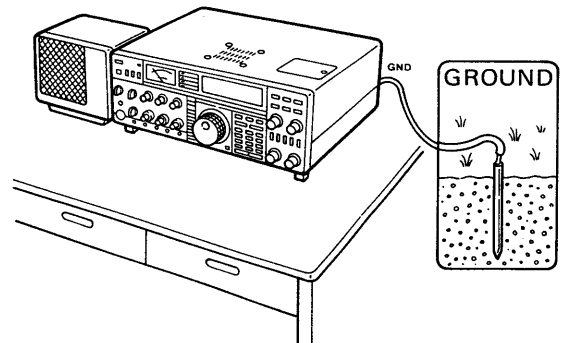

Use the heaviest gauge wire or strap available and make the connection as short as possible.

•PL-259 CONNECTOR INSTALLATION

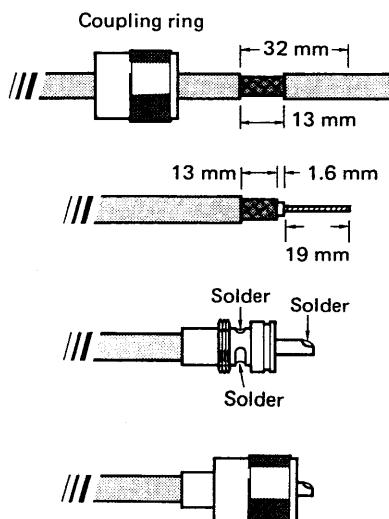

- 1) Slide the coupling ring over the coaxial cable.
- 2) Strip the cable as shown in the diagram, and soft solder the center conductor.
- 3) Slide the connector body onto the cable and solder.
- 4) Screw the coupling ring onto the connector body.

1 inch = 25.4 mm

3-5 FRONT AND REAR PANEL CONNECTIONS

(1) FRONT PANEL

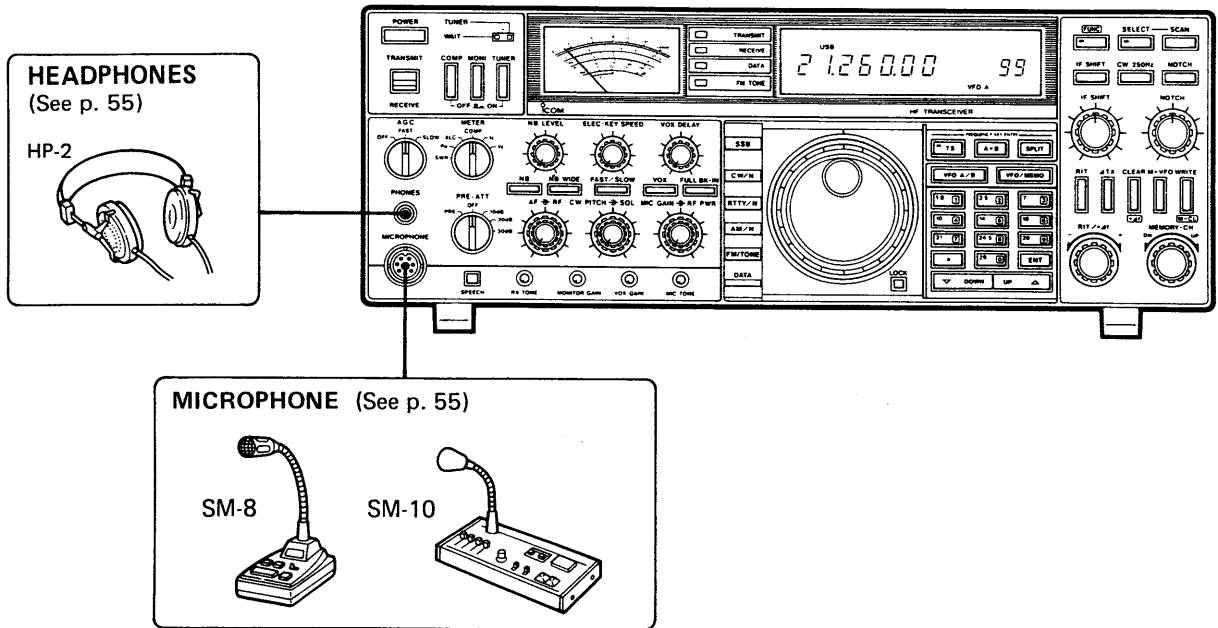

(2) REAR PANEL

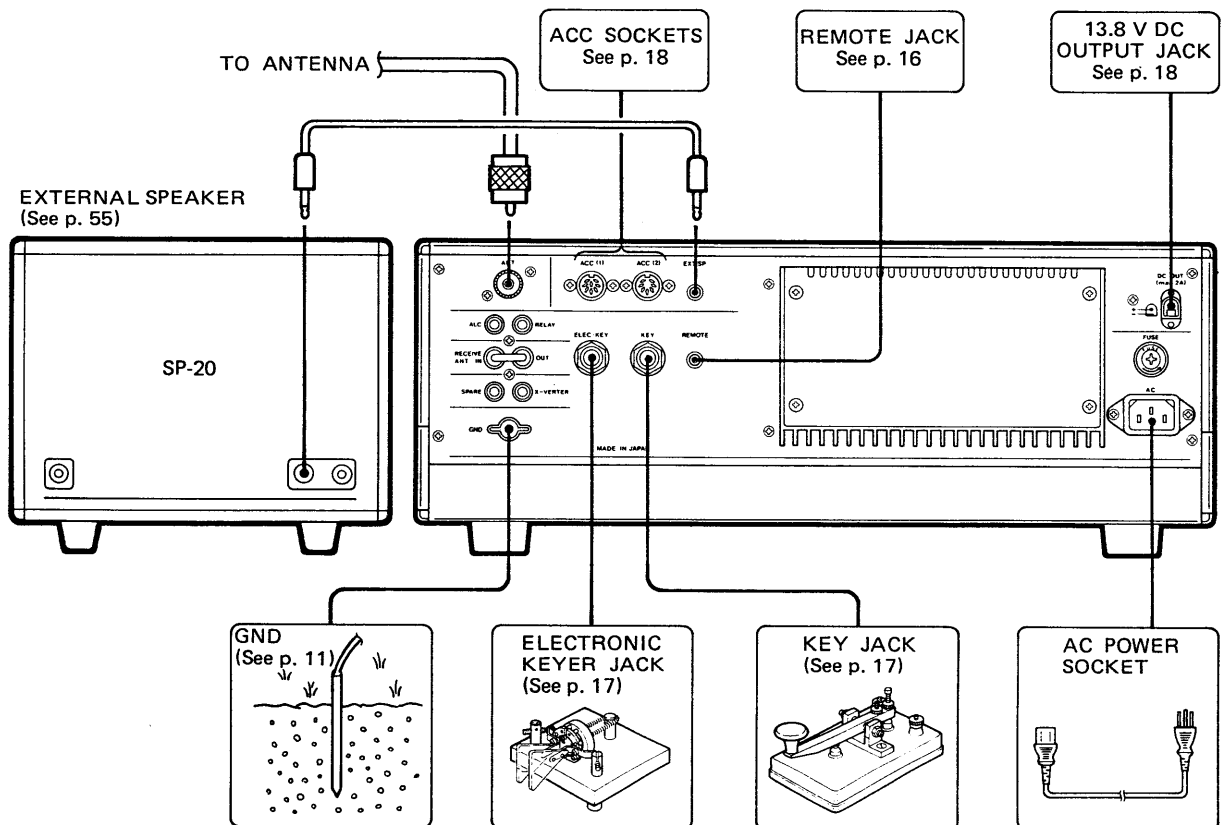

4-1 EXTERNAL LINEAR AMPLIFIER

(1) CONNECTING THE IC-4KL

To connect the IC-4KL 1 kW HF LINEAR AMPLIFIER, refer to the diagram below.

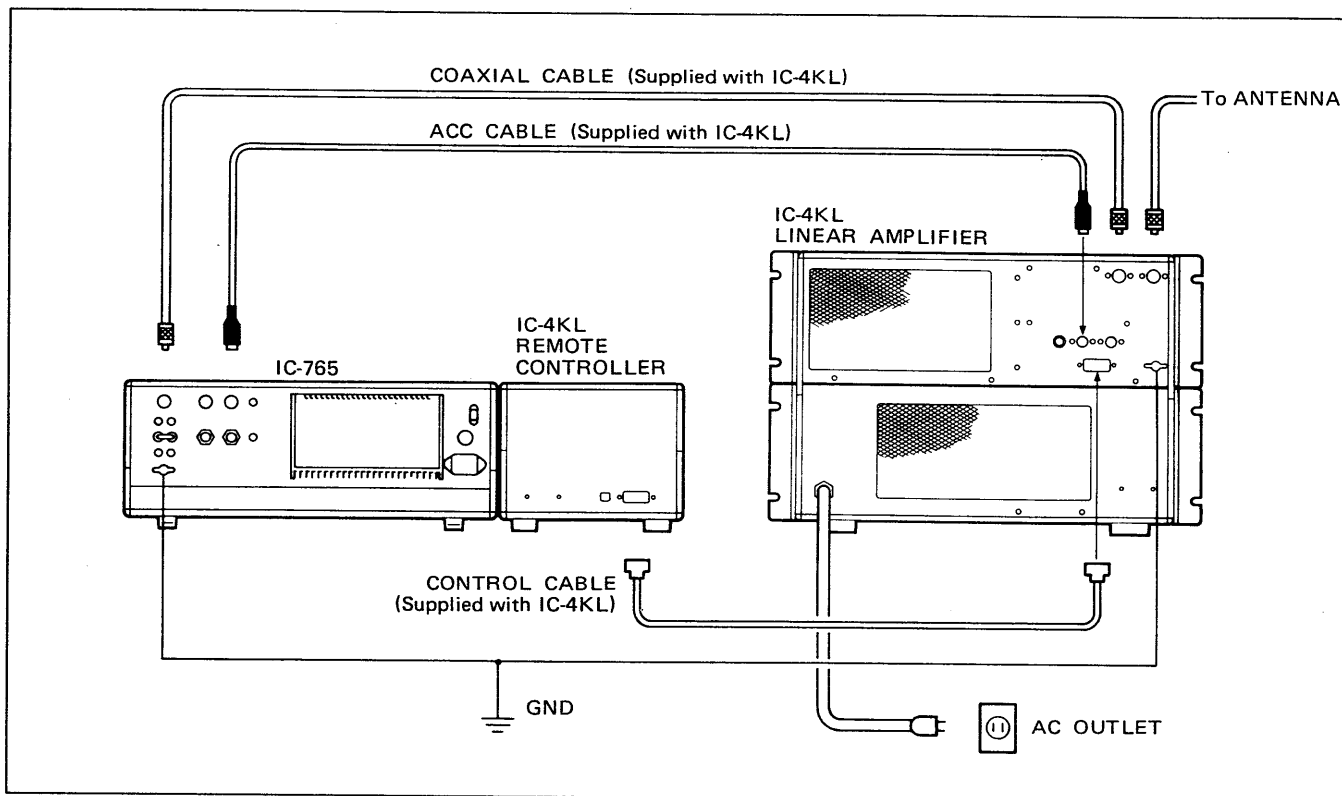

(2) CONNECTING A NON-ICOM LINEAR AMPLIFIER

To connect a linear amplifier not made by Icom, refer to the diagram below.

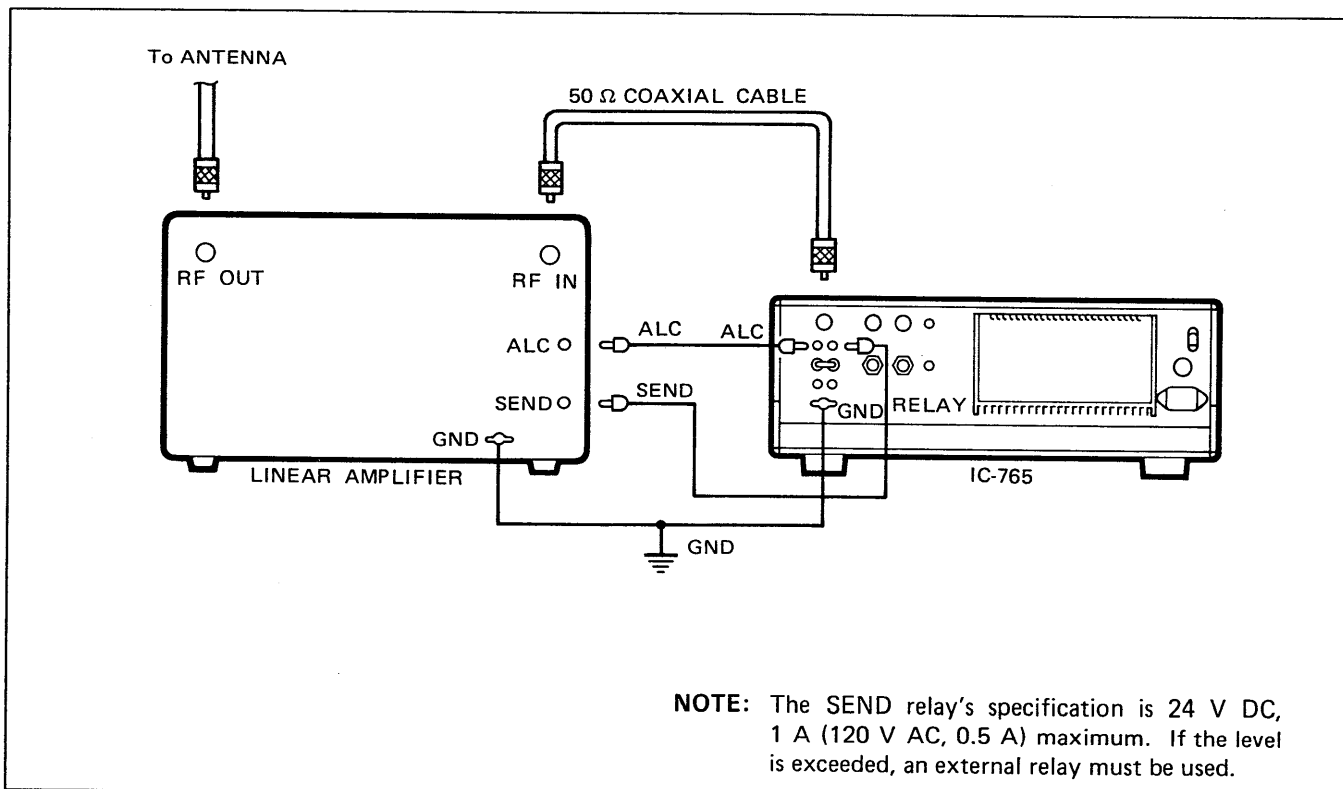

NOTE: The SEND relay's specification is 24 V DC, 1 A (120 V AC, 0.5 A) maximum. If the level is exceeded, an external relay must be used.

4-2 CONNECTING THE AH-2a

• Initial setting

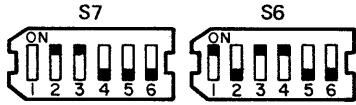

• Setting when connecting the AH-2a

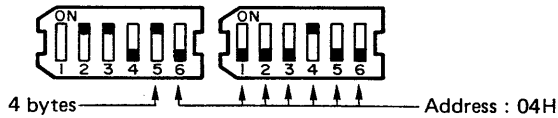

The AH-2a HF AUTOMATIC ANTENNA TUNER matches a long wire antenna with the IC-765.

1) Set s-1 ~ s-6 on S36 and s-6 on S37 address switches in the positions shown at left. See p. 52 for the address switch locations.

2) Connect cables as shown in the diagram below.

NOTE: Turn OFF (OUT) the [TUNER] switch on the IC-765 front panel while operating the AH-2a.

• Using the Icom AH-2a

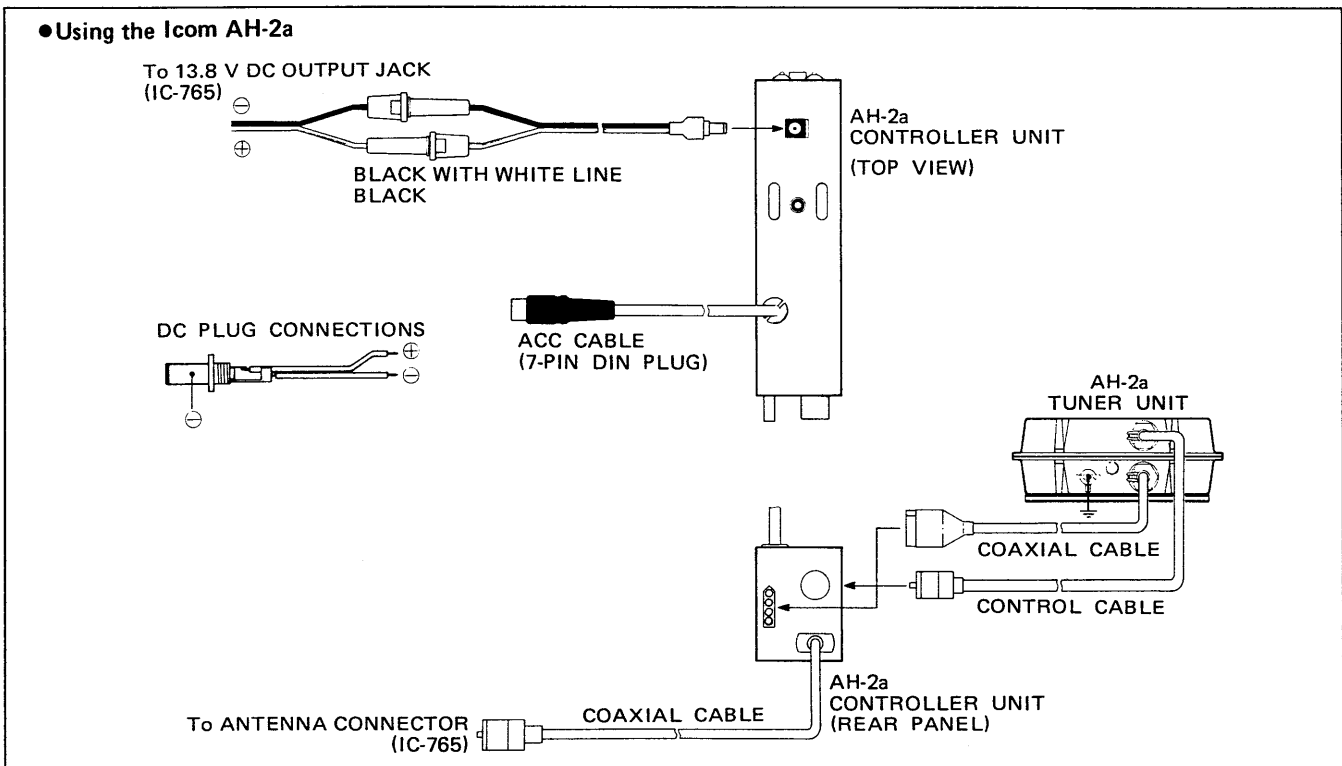

4-3 DATA COMMUNICATIONS

• USING THE ACC(1) SOCKET

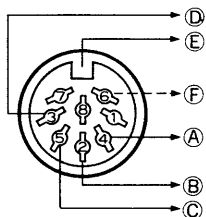

When operating AFSK, AMTOR or packet, connect external equipment to the ACC(1) socket on the rear panel or MIC CONNECTOR on the front panel.

In addition, read the instruction manual of an external unit for the connection.

• USING THE MIC CONNECTOR

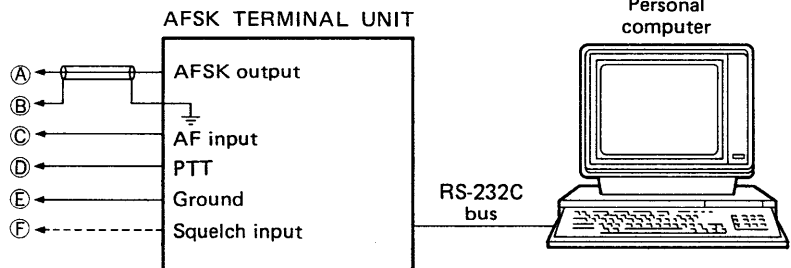
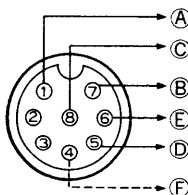

4 SYSTEM INTERCONNECTIONS

4-4 RTTY TERMINAL UNIT

To connect an RTTY terminal unit, refer to the diagram below.

●When using a high-speed relay

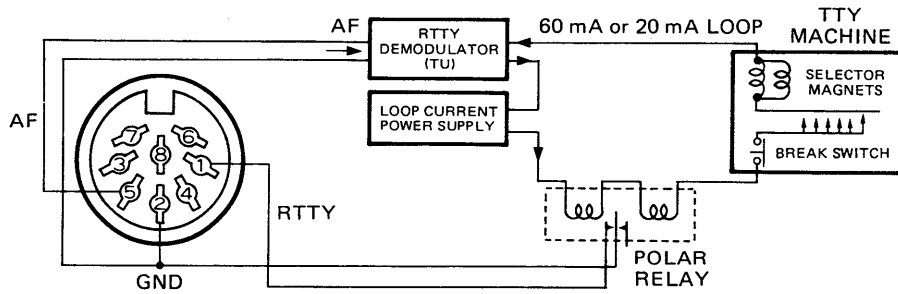

●When using a level converter

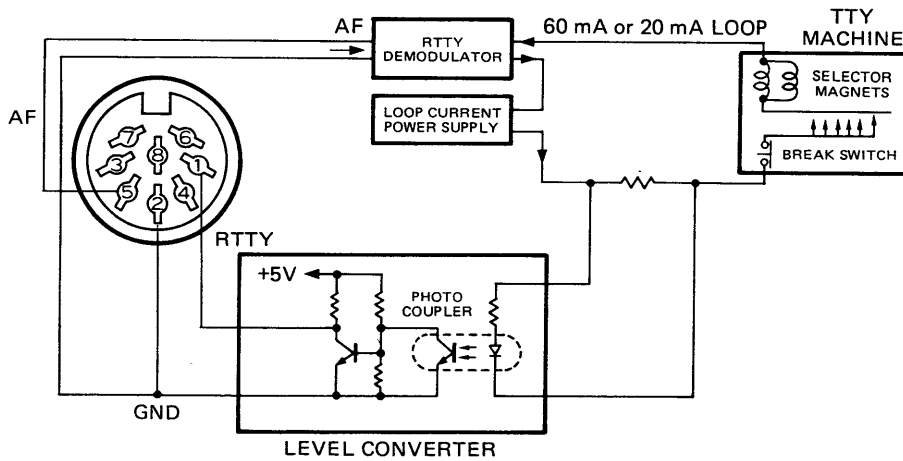

●When using an AFSK generator

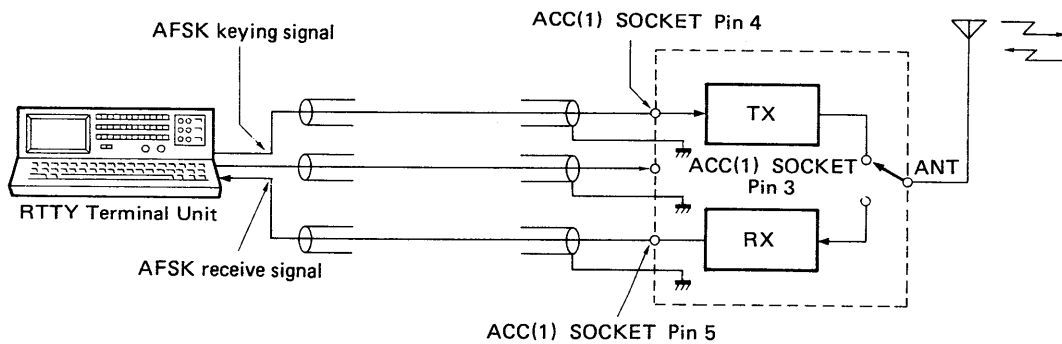

4-5 REMOTE JACK (CI-V)

(1) CI-V CONNECTION EXAMPLE

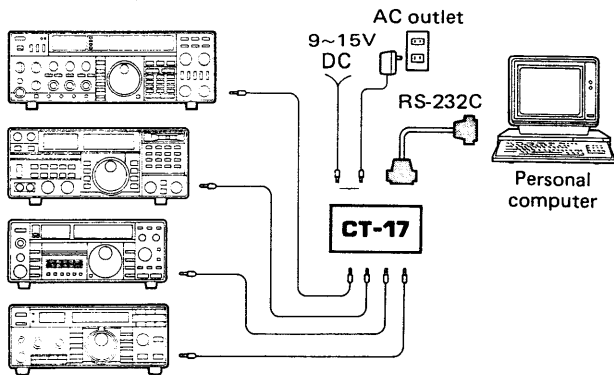

The IC-765 can be connected through a CT-17 CI-V LEVEL CONVERTER (option) to a personal computer equipped with an RS-232C I/O port. Icom Communication Interface - V (CI-V) controls frequency, mode, memory channels, etc.

Up to 4 Icom CI-V transceivers can be connected to a personal computer equipped with an RS-232C I/O port.

The CT-17 instruction manual describes some sample programs for controlling frequency, mode, memory channels, etc.

(2) CI-V CONDITION

Set the desired CI-V condition with S36 and S37. See p. 52 for the switch locations.

ITEM	DESCRIPTION	SWITCH SETTING :Default																															
BAUD RATE	<p>Baud rate is the data transfer rate. The standard Icom CI-V baud rate is 1200 bps.</p>	<table border="1"> <thead> <tr> <th rowspan="2">BAUD RATE (bps)</th> <th colspan="2">S37</th> </tr> <tr> <th>s-3</th> <th>s-4</th> </tr> </thead> <tbody> <tr> <td>300</td> <td>ON</td> <td>ON</td> </tr> <tr> <td>1200</td> <td>ON</td> <td>OFF</td> </tr> <tr> <td>4800</td> <td>OFF</td> <td>ON</td> </tr> <tr> <td>9600</td> <td>OFF</td> <td>OFF</td> </tr> </tbody> </table>	BAUD RATE (bps)	S37		s-3	s-4	300	ON	ON	1200	ON	OFF	4800	OFF	ON	9600	OFF	OFF														
BAUD RATE (bps)	S37																																
	s-3	s-4																															
300	ON	ON																															
1200	ON	OFF																															
4800	OFF	ON																															
9600	OFF	OFF																															
FREQUENCY DATA	<p>When connecting the transceiver to the Icom IC-735, change the value to 4 bytes.</p>	<table border="1"> <thead> <tr> <th>FREQUENCY DATA</th> <th>s-5 on S37</th> </tr> </thead> <tbody> <tr> <td>4 bytes</td> <td>ON</td> </tr> <tr> <td>5 bytes</td> <td>OFF</td> </tr> </tbody> </table>	FREQUENCY DATA	s-5 on S37	4 bytes	ON	5 bytes	OFF																									
FREQUENCY DATA	s-5 on S37																																
4 bytes	ON																																
5 bytes	OFF																																
TRANSCEIVER ADDRESS	<p>When the transceiver is controlled through the CI-V, the transceiver requires an independent address.</p> <p>The IC-765 has the address of 2CH (44) as a default value.</p> <p>H: Hexadecimal (): Decimal</p>	<table border="1"> <thead> <tr> <th rowspan="2">SWITCH</th> <th colspan="6">S36</th> <th>S37</th> </tr> <tr> <th>s-6</th> <th>s-5</th> <th>s-4</th> <th>s-3</th> <th>s-2</th> <th>s-1</th> <th>s-6</th> </tr> </thead> <tbody> <tr> <td>BCD</td> <td>(1)</td> <td>(2)</td> <td>(4)</td> <td>(8)</td> <td>(16)</td> <td>(32)</td> <td>(64)</td> </tr> <tr> <td>SWITCH POSITION</td> <td>OFF</td> <td>OFF</td> <td>ON</td> <td>ON</td> <td>OFF</td> <td>ON</td> <td>OFF</td> </tr> </tbody> </table>	SWITCH	S36						S37	s-6	s-5	s-4	s-3	s-2	s-1	s-6	BCD	(1)	(2)	(4)	(8)	(16)	(32)	(64)	SWITCH POSITION	OFF	OFF	ON	ON	OFF	ON	OFF
SWITCH	S36						S37																										
	s-6	s-5	s-4	s-3	s-2	s-1	s-6																										
BCD	(1)	(2)	(4)	(8)	(16)	(32)	(64)																										
SWITCH POSITION	OFF	OFF	ON	ON	OFF	ON	OFF																										
TRANSCEIVE OPERATION	<p>Transceive operation is possible using the IC-765 with other equipment such as the IC-781 or IC-R71A/E/D.</p>	<table border="1"> <thead> <tr> <th>TRANSCEIVE</th> <th>s-2 on S37</th> </tr> </thead> <tbody> <tr> <td>ON</td> <td>ON</td> </tr> <tr> <td>OFF</td> <td>OFF</td> </tr> </tbody> </table>	TRANSCEIVE	s-2 on S37	ON	ON	OFF	OFF																									
TRANSCEIVE	s-2 on S37																																
ON	ON																																
OFF	OFF																																

4 SYSTEM INTERCONNECTIONS

4-6 MIC CONNECTOR

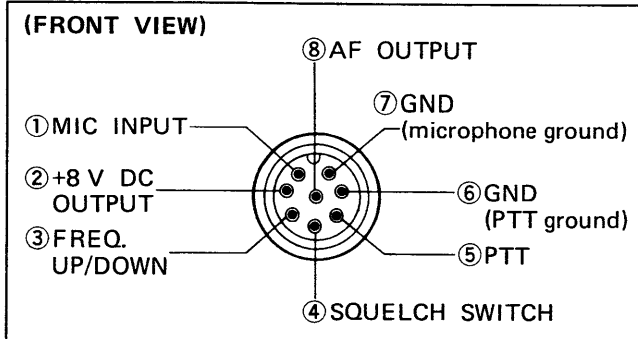

PIN NO.	FUNCTION	DESCRIPTION
2	+8 V DC output	Max. 10 mA
3	Frequency up Frequency down	Ground Ground through 470 Ω
4	Squelch open Squelch closed	"LOW" level "HIGH" level

CAUTION: DO NOT short pin 2 to ground as this can damage the internal 8 V regulator.

4-7 RECEIVER ANTENNA JACKS

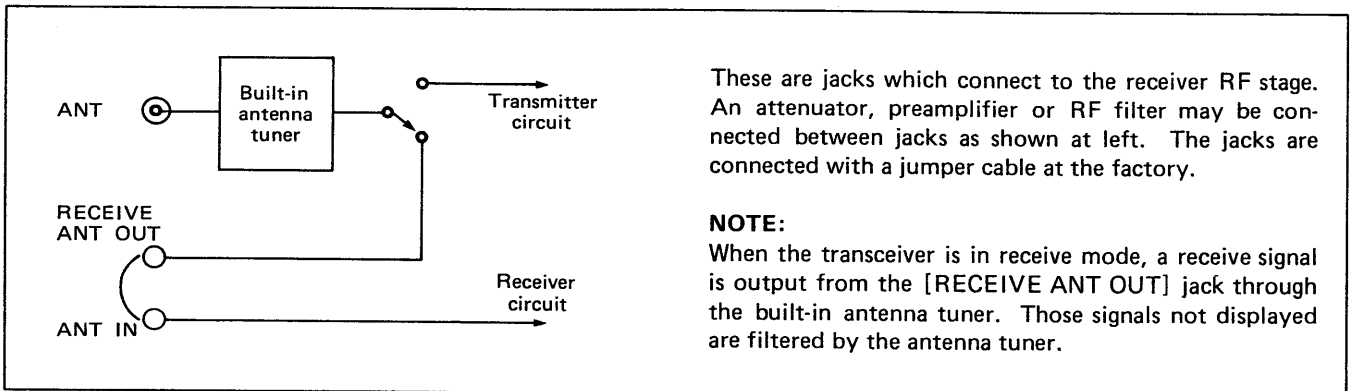

4-8 KEY JACKS

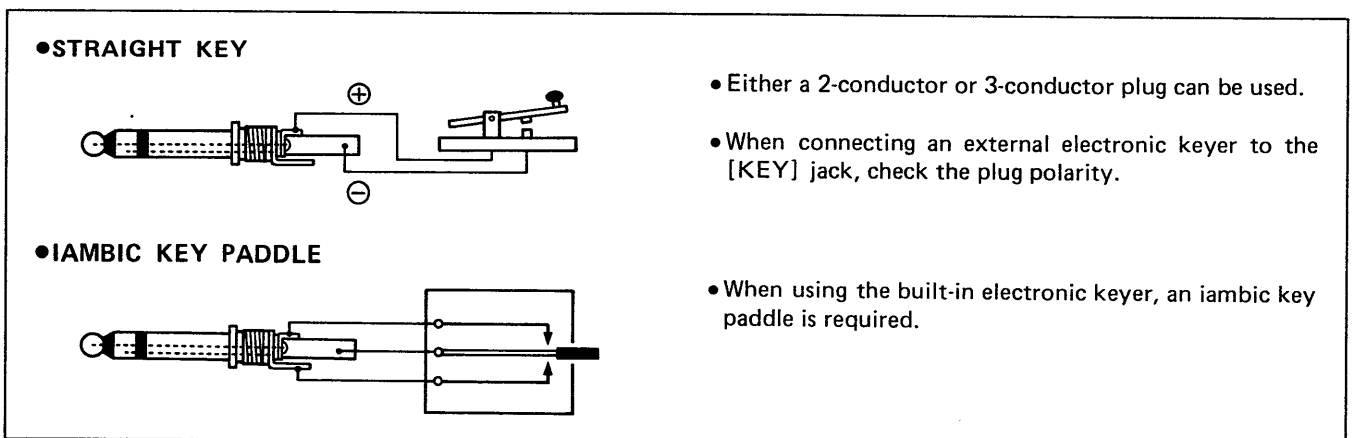

4-9 TRANSVERTER JACK

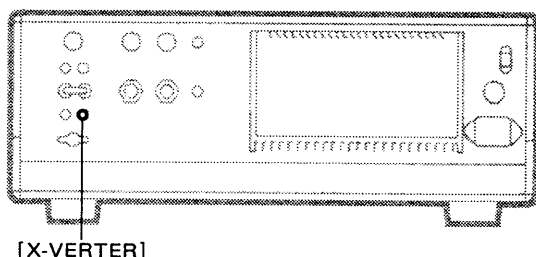

When 2 ~ 13.8 V is applied to pin 6 of ACC(2), this jack outputs signals of the displayed frequency at -20 dBm (30 mV) as a signal for an external transverter. Refer to p. 18.

When no voltage is applied to pin 6 of ACC(2), this jack is activated as an input terminal from an external transverter. Refer to p. 18.

4-10 ACC SOCKETS

(1) ACC(1) SOCKET

ACC(1)	PIN NO.	PIN NAME	DESCRIPTION	SPECIFICATIONS
	1	RTTY	Controls RTTY keying.	"HIGH" level : More than 2.4 V "LOW" level : Less than 0.6 V Output current : Less than 2 mA
	2	GND	Connects to ground.	Connected in parallel with ACC(2) pin 2.
	3	SEND	Input/Output pin. Goes to ground when transmitting. When grounded, transmits.	Grounded level : $-0.5 \sim +0.8$ V Input current : Less than 20 mA Connected in parallel with ACC(2) pin 3.
	4	MOD	Modulator input. Connects to a modulator.	Input imp. : $10 \text{ k}\Omega$ Input level : Approx. 100 mV rms
	5	AF	AF detector output. Fixed, regardless of [AF GAIN].	Output imp. : $4.7 \text{ k}\Omega$ Output level : $100 \sim 300$ mV rms
	6	SQLS	Squelch output. Goes to ground when SQL opens.	SQL open : Less than 0.3 V/5 mA SQL closed : More than 6.0 V/100 μ A
	7	13.8 V	13.8 V output when power is ON.	Output current : Max. 1 A Connected in parallel with ACC(2) pin 7.
	8	ALC	ALC voltage input.	Control voltage : $-4 \sim 0$ V Input imp. : More than $10 \text{ k}\Omega$ Connected in parallel with ACC(2) pin 5.

(2) ACC(2) SOCKET

ACC(2)	PIN NO.	PIN NAME	DESCRIPTION	SPECIFICATIONS
	1	8 V	Regulated 8 V output	Output voltage : $8 \text{ V} \pm 0.3 \text{ V}$ Output current : Less than 10 mA
	2	GND	Same as ACC(1) pin 2.	
	3	SEND	Same as ACC(1) pin 3.	
	4	BAND	Band voltage output (varies with amateur band). Connects to external unit (e.g., antenna tuner)	Output voltage : $0 \sim 8.0 \text{ V}$
	5	ALC	Same as ACC(1) pin 8.	
	6	TRV	Switching voltage input. Activates [X-VERTER] output/input.	Input imp. : More than $10 \text{ k}\Omega$ Input voltage : $2 \sim 13.8 \text{ V}$
	7	13.8 V	Same as ACC(1) pin 7.	

4-11 13.8V DC OUTPUT JACK

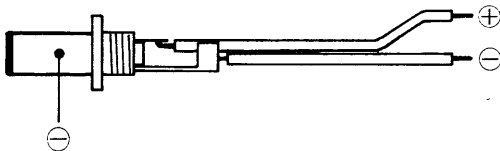

This jack outputs 13.8 V, 2 A maximum.

One fuse (2 A) is installed in the circuit. See p. 41 for the fuse holder location.

5-1 INITIAL SETTINGS

After all installation instructions have been followed in Section 3 INSTALLATION, set the controls and switches as shown in the diagram below.

- 1) Turn the [POWER] switch OFF.
- 2) Plug the AC power cable into a domestic AC outlet.
- 3) The transceiver must be grounded at the GROUND terminal.
- 4) Connect an antenna to the [ANT] connector.

CAUTION: Transmitting without an antenna may damage the transceiver.

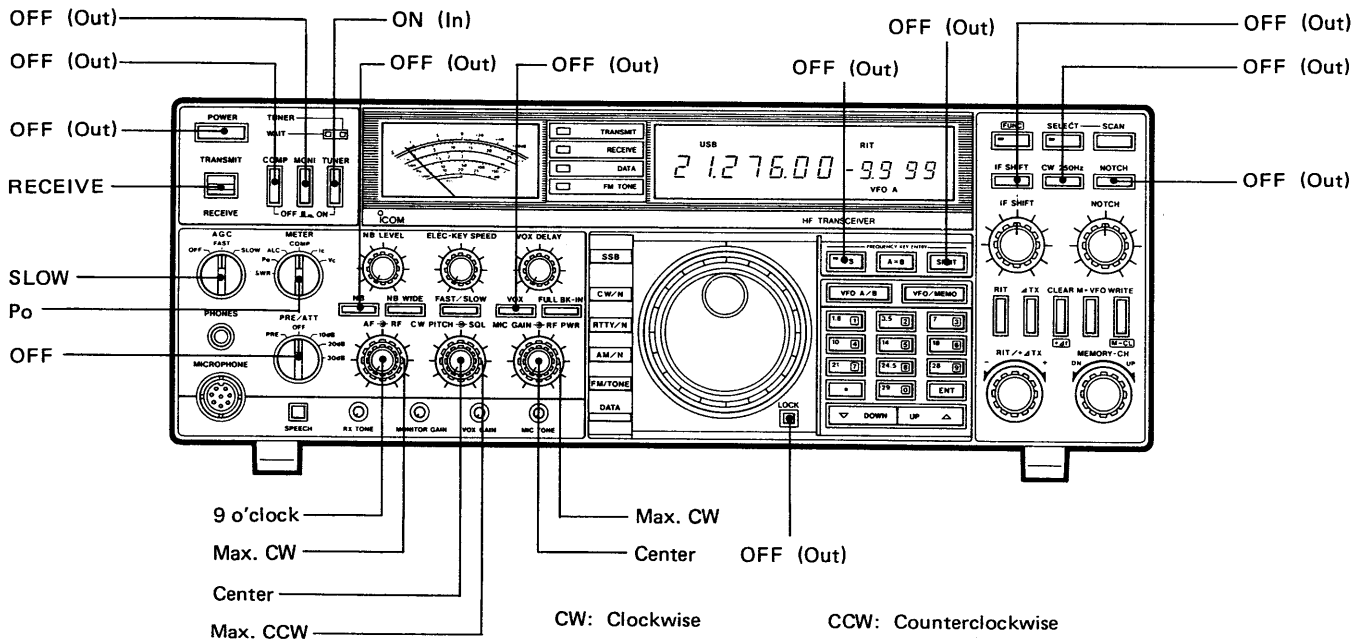

Tech Talk from Icom

Q. What is the function of the band stacking register?

A. The band stacking register stores operating frequencies in VFO modes, switches bands, and returns the transceiver to stored frequencies.

This is especially convenient when switching bands during contests and for quick monitoring of propagation conditions on other bands.

●BAND STACKING REGISTER EXAMPLE

Each band stores the last used frequency and mode.

The displayed frequency is kept until new information is input.

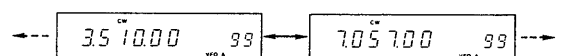

5-2 OPERATING BAND SELECTION

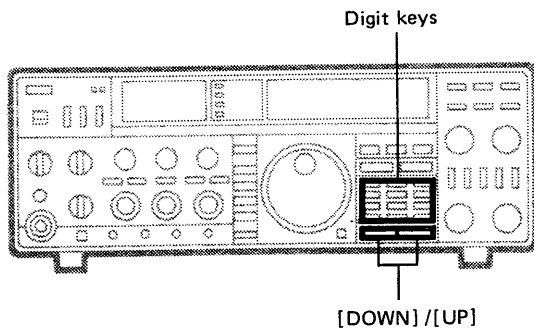

The IC-765 covers all HF amateur bands from 1.9 MHz ~ 28 MHz for transmitting and has receive capability from 100 kHz ~ 30 MHz. The IC-765 has a convenient band stacking register function. (See p. 19)

- 1) Push the digit key with an amateur band printed on the key to select the desired amateur band.
- 2) Push either the [DOWN] or [UP] switch to change the displayed frequency in 1 MHz steps.
- 3) Rotate the main dial to select the desired frequency.
 - See Section 5 - 4 for the tuning speed selection.

5-3 OPERATING FREQUENCY SELECTION

[EXAMPLES] Push the [FUNC] switch before entering digits.

- **Set frequency at 7.00000 MHz.**
Push [7] then [ENT].
- **Set frequency at 7.10000 MHz.**
Push [7] [.] [1] then [ENT].
- **Set frequency at 28.12345 MHz.**
Push [2] [8] [.] [1] [2] [3] [4] [5] then [ENT].
- **Change frequency from 28.12345 MHz to 28.45500 MHz.**
Push [.] [4] [5] [5] then [ENT].
- **Set frequency at 234 kHz (0.23400 MHz).**
Push [0] [.] [2] [3] [4] then [ENT].

- 1) Push the [FUNC] switch.
 - The red indicator lights up.
- 2) Enter the desired frequency.
 - Push the [.] key after entering MHz and before entering kHz.
- 3) Push the [ENT] key to enter the frequency.
- 4) To enter 0 in succession, push the [ENT] key once.
- 5) Rotate the main dial to select the desired frequency.
 - See Section 5 - 4 for the tuning speed selection.

5-4 TUNING SPEED SELECTION

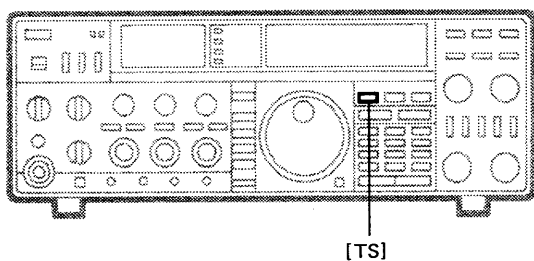

Normal rotation of the main dial changes the frequency increment for 5 kHz per full rotation in 10 Hz steps. Faster main dial rotation automatically shifts the tuning increment for 10 kHz per full rotation in 10 Hz steps.

- 1) When the [TS] switch is pushed IN, frequency increments shift in 1 kHz steps while in any operating mode.
- 2) To change the frequency increment from 5 kHz to 2.5 kHz per full rotation, See Section 11 - 4 on p. 46.

5-5 VFO A AND VFO B SELECTION

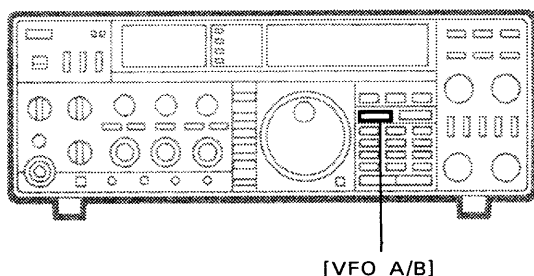

The IC-765 contains two VFOs which both receive and transmit. The VFOs are called VFO A and VFO B. This dual VFO system provides tremendous operating flexibility.

Pushing the [VFO A/B] switch each time alternately selects VFO A or VFO B.

5 PRE-OPERATION

5-6 RECEIVER CONTROLS AND SWITCHES

Adjust the following controls and switches on the front panel for optimum reception. It may be convenient to refer to this section while you are receiving.

NOISE BLANKER CONTROL AND SWITCHES (p. 32)

Use the following switches with the [NB LEVEL] control.

- **When [NB] is pushed IN:**
Reduces pulse-type noise such as from car ignitions.
- **When both [NB] and [NB WIDE] are pushed IN:**
Reduces wide pulse-type noise known as "woodpecker" noise.

AGC SWITCH (p. 31)

- **OFF position:**
Used when receiving a very weak signal.
- **FAST position:**
Normally used when receiving a signal in CW and RTTY modes.
- **SLOW position:**
Normally used when receiving a signal in SSB or AM modes.

PREAMP/ATTENUATOR SWITCH [PRE] position:

Use when receiving weak signals. Set the switch to the [PRE] position, the built-in preamp (approx. 10 dB) is activated to improve the S/N ratio and sensitivity. Especially useful during DX operation.

[10dB] [20dB] [30dB] positions:

Used when the received sound from the speaker is distorted by very strong signals. Set the switch to these positions to activate the 10, 20, or 30 dB attenuator.

RX TONE CONTROL

Changes the audio output quality from the speaker.

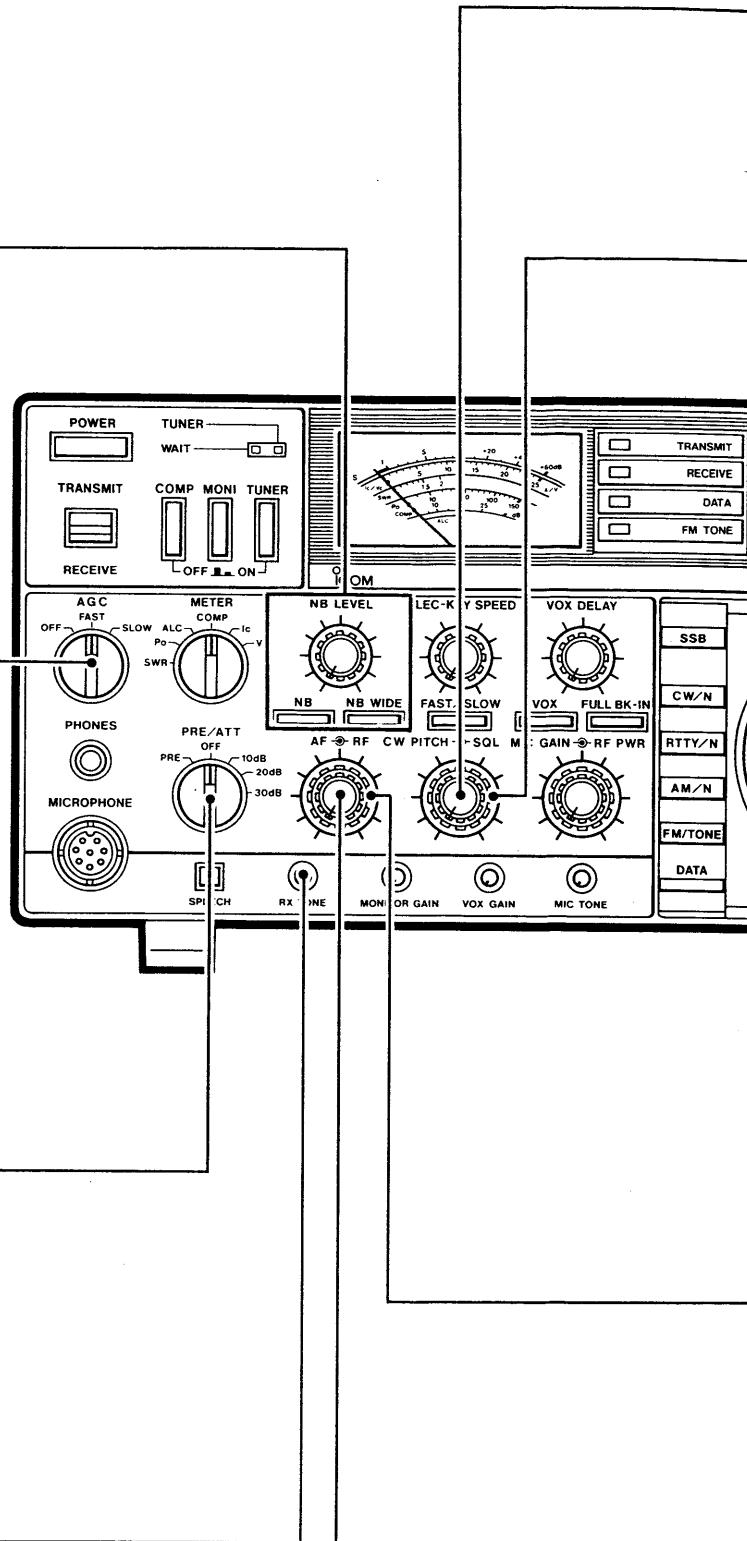

CW PITCH CONTROL

Changes receive audio tone in CW mode.

SQUELCH CONTROL

Mutes the audio output from the speaker. Signals and noises that are stronger than the squelch threshold level open the squelch and audio is emitted from the speaker.

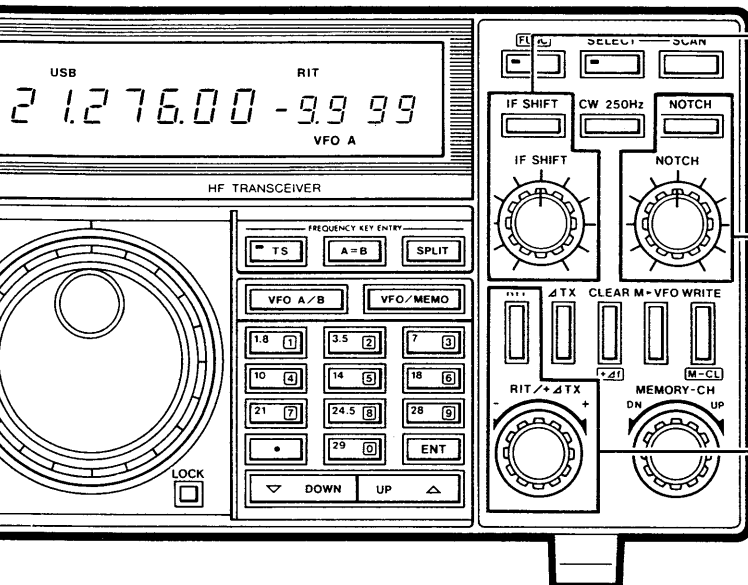

IF SHIFT SWITCH AND CONTROL

Reduces interference from adjacent frequency signals. The IF shift is not effective in AM and FM modes.

NOTCH FILTER SWITCH AND CONTROL (p. 31)

Reduces interference such as beat signals. The notch filter is not effective in FM mode.

RIT SWITCH AND CONTROL (p. 35)

Fine tunes stations which call off frequency or compensates for frequency drift. Shifts receive frequency without shifting the transmit frequency when the [RIT] switch is pushed.

RF GAIN CONTROL

Adjusts the gain of the RF amplifier located in the receiver front end. Normally the control should be maximum clockwise for maximum receiver sensitivity.

AF GAIN CONTROL

Varies the audio output level from the speaker. Clockwise rotation increases the volume.

5-7 TRANSMITTER CONTROLS AND SWITCHES

ANTENNA TUNER SWITCH (p. 32)

Matches your antenna and transceiver. Even if the SWR of your antenna system is about 3:1, the built-in tuner matches the antenna system to 50 Ω.

MONITOR SWITCH (p. 33)

Monitors your transmit signals. Use this switch with the [MONITOR GAIN] control.

SPEECH COMPRESSOR SWITCH (p. 33)

Increases talk power in SSB mode. Use this switch with the [MIC GAIN] control.

TRANSMIT/RECEIVE SWITCH

Manually switches from receiving to transmitting or vice versa.

METER SWITCH (p. 5)

Measures values for voltage and current of final transistors, ALC and compression levels, SWR and relative output power level. Set the switch to the desired position.

MONITOR GAIN CONTROL (p. 33)

Adjusts the monitor gain. Use the control with the [MONI] switch.

VOX GAIN CONTROL (p. 32)

Adjusts the VOX gain. Rotate the control clockwise to switch to transmit mode. Clockwise rotation increases the gain and the VOX switches to transmit mode even when your voice level is low.

MIC GAIN CONTROL (p. 33)

Adjusts the mic gain. Adjust this control to the point where the meter needle is within the ALC zone while speaking into the mic using your normal voice level.

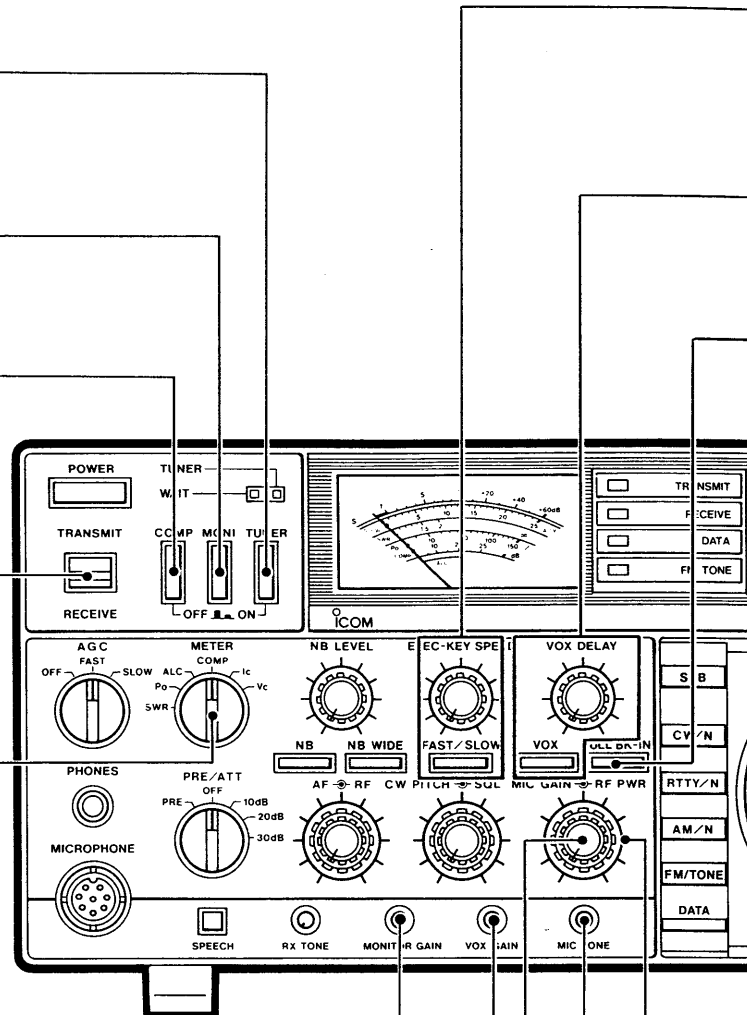

ELECTRONIC KEYSER SPEED CONTROL AND SWITCH (p. 26)

Changes keying speed when operating in CW mode with the built-in electronic keyer. Use this control with the [FAST/SLOW] switch.

VOX DELAY CONTROL AND VOX SWITCH (p. 32)

Provides VOX operation. The [VOX] control can change the switching time of transmit to receive during pauses in your speech or CW transmission.

FULL BREAK-IN SWITCH (p. 26)

Provides full break-in CW operation. The [VOX] switch must be pushed IN.

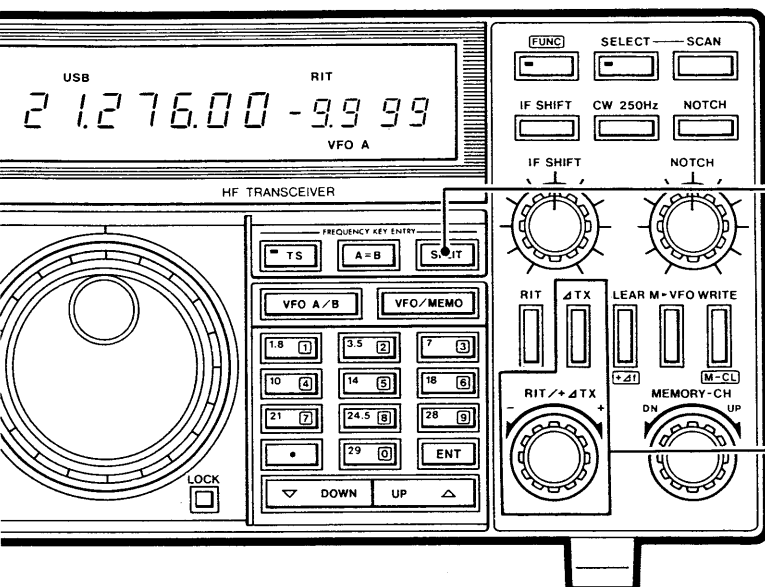

SPLIT SWITCH (p. 34)

Provides transmit on one frequency and receive on another.

ΔTX SWITCH AND CONTROL (p. 35)

Fine tunes stations which call off frequency or compensates for frequency drift. Shifts transmit frequency without shifting the receive frequency when the [ΔTX] switch is pushed.

RF POWER CONTROL

Changes the RF output power. Adjust this control for the desired output power level.

Maximum output power

- SSB : 100 W PEP
- CW, FM, RTTY : 100 W
- AM : 40 W

MIC TONE CONTROL

Adjusts the transmit sound quality.

Tech Talk from Icom

Q: What is ALC?

A: ALC means Automatic Level Control. The ALC circuit limits output power by controlling the input level of the RF power amplifier.

The RF power amplifier is designed as a linear amplifier to amplify an input signal proportionally. The linear amplifier functions in the linear area of

the signal. However, if the input signal level exceeds the limit of linearity, the linear amplifier outputs distorted signals because the signal is amplified in a non-linear area of the signal.

To prevent transmitting distorted signals, the ALC circuit detects a signal and applies it to a driver amplifier as feedback to reduce driver output power.

Therefore, the input signal level to the RF power amplifier is reduced and the transceiver transmits clear signals.

6-1 SSB OPERATION

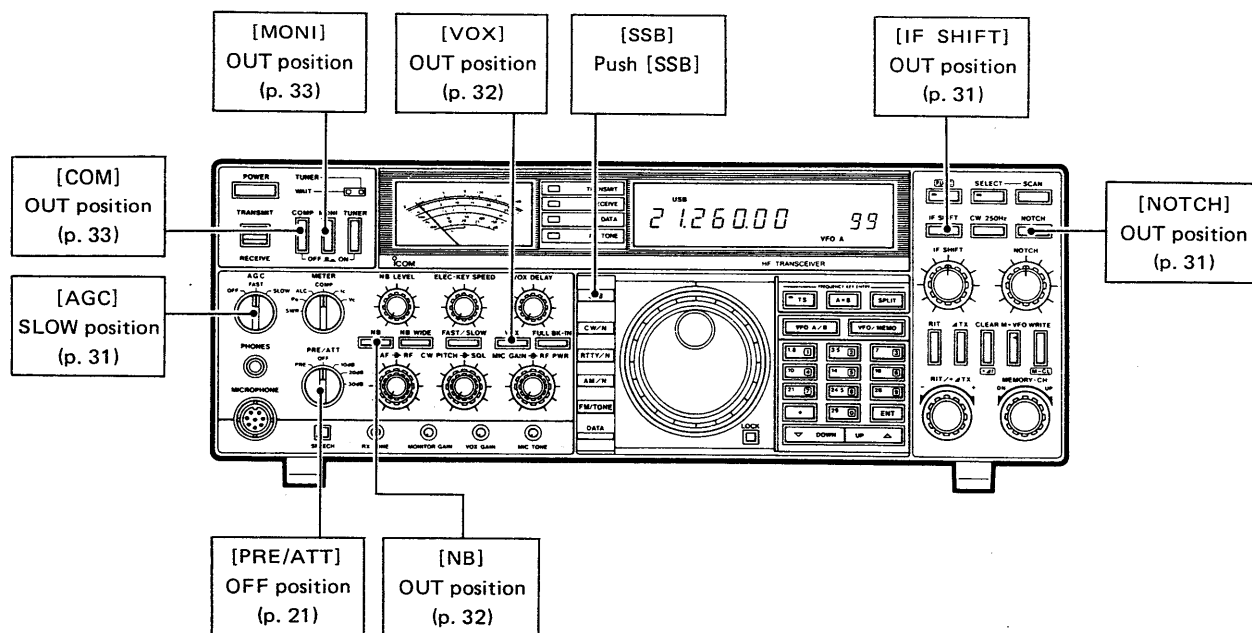
**(1) SSB RECEIVING**

- 1) Set controls and switches as described on p. 19.
- 2) Push [POWER] IN.
- 3) Select the desired operating band. (See p. 20)
- 4) Push [SSB] to select SSB mode.
 - USB is automatically selected on bands above 10 MHz.
 - LSB is automatically selected on bands below 7 MHz.
 - Push [SSB] again to select the opposite side of the side band.
- 5) Adjust [AF] as desired.
- 6) Adjust [SQL], if needed.
- 7) Rotate the main dial to receive a signal.
- 8) Use the controls and switches described on pgs. 21 and 22 for better receiving.

(2) SSB TRANSMITTING

- 1) Set controls and switches as described on p. 19.
- 2) Set [METER] to the [Po] position to view relative output power on the meter.
- 3) Push and hold the PTT switch on the microphone or set [TRANSMIT/RECEIVE] to TRANSMIT.
- 4) Speak naturally into the microphone.
 - When you transmit a signal, the meter needle moves.
- 5) Adjust [RF PWR] for the desired output power.
- 6) Set [METER] to the [ALC] position.
- 7) Adjust [MIC]. The meter needle should be within the ALC zone.
 - Push [COMP] switch, if needed. (See p. 33)
 - Adjust [MIC TONE], if needed.

■ SSB SELECTIVITY INFORMATION

SELECTIVITY
2.2 kHz/−6 dB

6-2 CW OPERATION

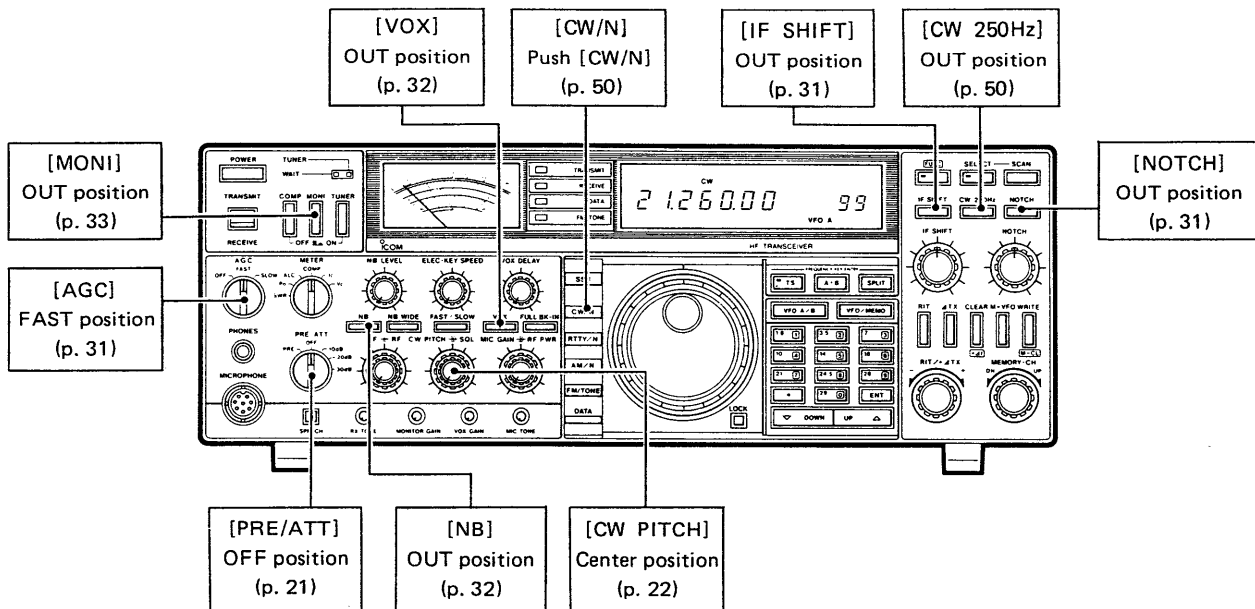

(1) CW RECEIVING

- 1) Set controls and switches as described on p. 19.
- 2) Push [POWER] IN.
- 3) Select the desired operating band. (See p. 20)
- 4) Push [CW/N].
 - Push [CW/N] again to select the CW narrow filter.
 - When operating CW with a 250 Hz narrow filter, an optional CW narrow filter is required. (See p. 50)
- 5) Set [AGC] to the [FAST] position.
- 6) Adjust [AF] as desired.
- 7) Adjust [CW PITCH] if needed.
- 8) Adjust [SQL], if needed.
- 9) Rotate the main dial to receive a signal.

(2) CW TRANSMITTING

- Plug a straight key or iambic key paddle into the [KEY] or [ELEC-KEY] jack on the rear panel respectively.
- 1) Select non break-in, semi break-in or full break-in:
 - Non break-in : Set [TRANSMIT/RECEIVE] to TRANSMIT.
 - Semi break-in : Push [VOX].
 - Full break-in : Push both [VOX] and [FULL BK-IN].
 - 2) Operate the CW key.
 - 3) For semi break-in operation, adjust [VOX DELAY] to set the break-in delay time.
 - 4) When using an iambic key paddle, adjust [ELEC-KEY SPEED] with [FAST/SLOW] to suit your keying speed.
 - 5) Adjust [MONITOR GAIN] to the desired sidetone level.
 - 6) Transmit/receive switching is:
 - automatic when semi or full break-in is used.
 - manual with the [TRANSMIT/RECEIVE] switch.

■ CW SELECTIVITY INFORMATION

MODE		SELECTIVITY
CW		2.2 kHz/− 6 dB
CW-N	[CW 250 Hz] : OFF	500 Hz/−6 dB
	[CW 250 Hz] : ON (optional)	250 Hz/−6 dB

6-3 RTTY OPERATION

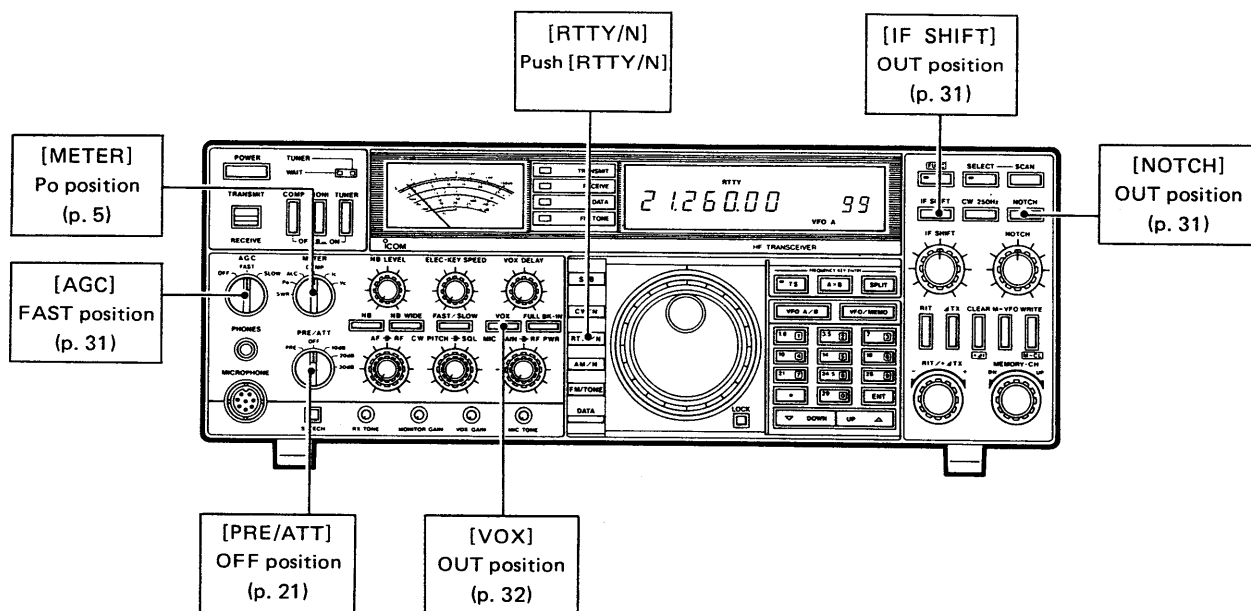

(1) RTTY RECEIVING

- 1) Connect a teletypewriter or terminal unit. (See p. 15)
- 2) Set controls and switches as described on p. 19.
- 3) Push [POWER] IN.
- 4) Select the desired operating band. (See p. 20)
- 5) Push [RTTY/N].
 - Push [RTTY/N] again to select the RTTY narrow filter.
- 6) Adjust [AF] as desired.
- 7) Adjust [SQL], if needed.
- 8) Rotate the main dial. Tune in an RTTY signal. Use the tuning indicator of the terminal unit.

(2) RTTY TRANSMITTING

- 1) Set [METER] to the [Po] position.
- 2) Set [TRANSMIT/RECEIVE] to TRANSMIT.
- 3) Adjust [RF PWR] for the desired output power.
- 4) Type using your RTTY keyboard.

• The following mark/space frequencies are set as default at the factory. To change the default, see p. 46.

Mark frequency : 2125 Hz
 Space frequency : 2295 Hz
 Shift width : 170 Hz

■ RTTY SELECTIVITY INFORMATION

MODE	SELECTIVITY
RTTY	2.2 kHz/−6 dB
RTTY-N	500 Hz/−6 dB

6-4 AM OPERATION

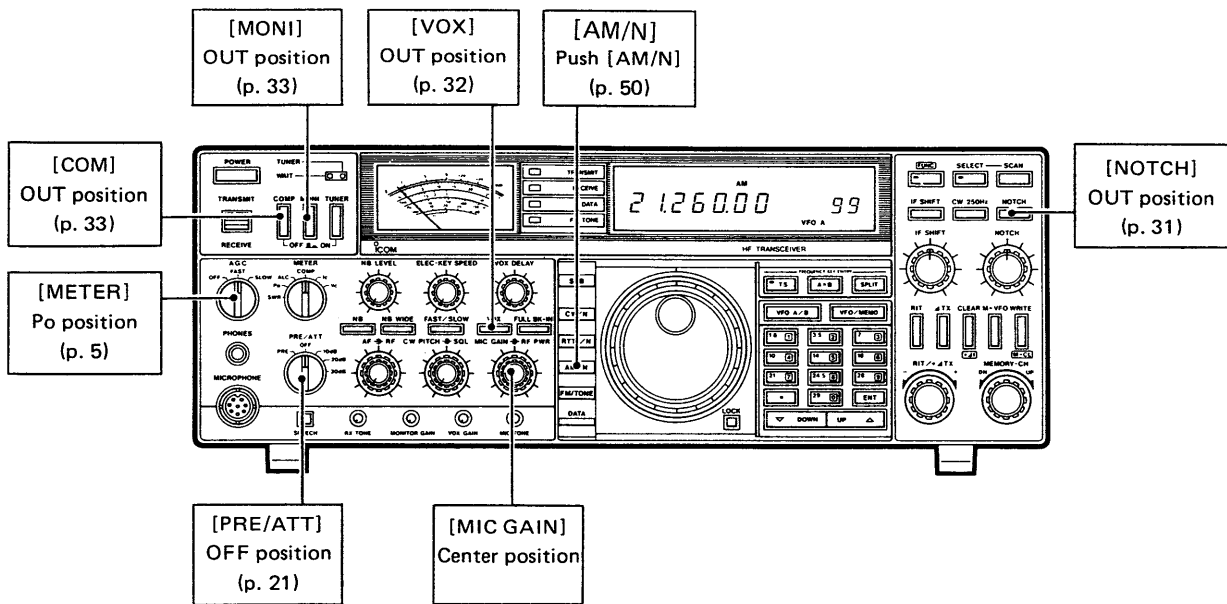

(1) AM RECEIVING

- 1) Set controls and switches as described on p. 19.
- 2) Push [POWER] IN.
- 3) Select the desired operating band. (See p. 20)
- 4) Push [AM/N].
 - Push [AM/N] again to select the AM narrow filter.
- 5) Adjust [AF] as desired.
- 6) Adjust [SQL], if needed.
- 7) Rotate the main dial to receive a signal.

(2) AM TRANSMITTING

- 1) Set controls and switches as described on p. 19.
- 2) Set [METER] to the [Po] position to view relative output power on the meter.
- 3) Push and hold the PTT switch on the microphone or set [TRANSMIT/RECEIVE] to TRANSMIT.
- 4) Speak naturally into the microphone.
 - The meter needle indicates a point and moves slightly according to your voice level.
- 5) Adjust [RF PWR] for the desired output power.
 - Maximum output power : 40 W

■ AM SELECTIVITY INFORMATION

MODE	SELECTIVITY
AM	6 kHz/-6 dB
AM-N	2.8 kHz/-6 dB

6-5 FM OPERATION

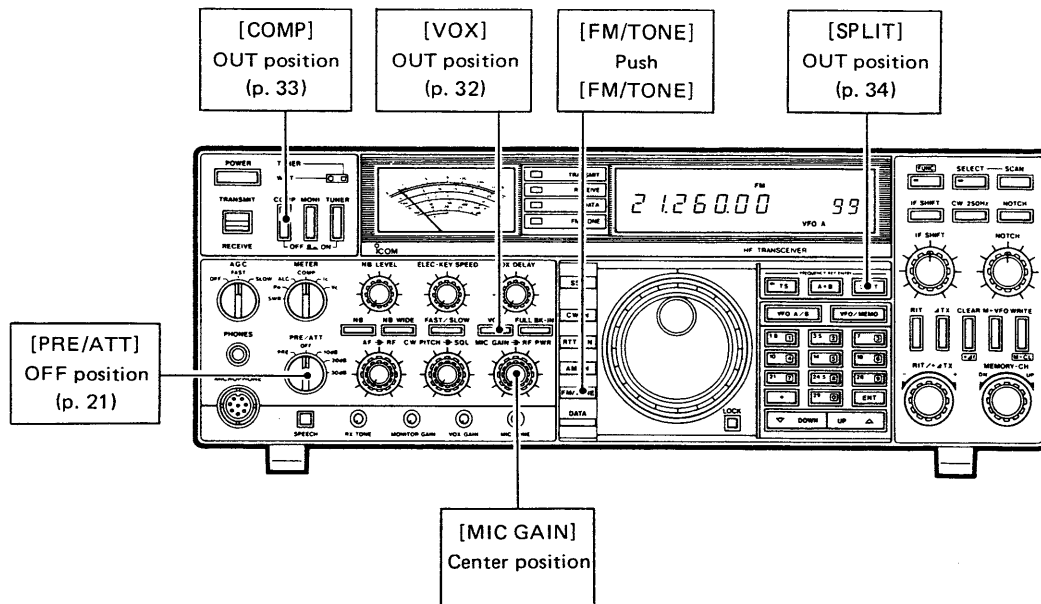

(1) FM RECEIVING

- 1) Set controls and switches as described on p. 19.
- 2) Push [POWER] IN.
- 3) Select the desired operating band. (See p. 20)
- 4) Push [FM/TONE].
- 5) Adjust [AF] as desired.
- 6) Set [SQL] to the threshold point.
- 7) Rotate the main dial to receive a signal.
 - If a received signal is strong enough, the needle of the S-meter moves and the squelch opens.

■ FM SELECTIVITY INFORMATION

SELECTIVITY
15 kHz/-6 dB

(2) FM TRANSMITTING

- 1) Set controls and switches as described on p. 19.
- 2) Set [METER] to the [Po] position to view relative output power on the meter.
- 3) Set [MIC GAIN] at 12 o'clock.
- 4) Push and hold the PTT switch on the microphone or set [TRANSMIT/RECEIVE] to TRANSMIT.
- 5) Speak naturally into the microphone.
 - The meter needle indicates a point and moves slightly according to your voice level.
- 6) Adjust [RF PWR] for the desired output power.
- 7) To make a split operation through a repeater, see p. 34.
- 8) To transmit a subaudible tone signal, the optional UT-30 is necessary. See p. 48 for the installation.
 - Push [FM/TONE] again to transmit a tone signal.
 - The [FM/TONE] indicator lights up.
- 9) To stop transmitting the tone signal, push [FM/TONE] again.

6-6 DATA COMMUNICATION

Read the instruction manual of your terminal unit before connecting and operating.

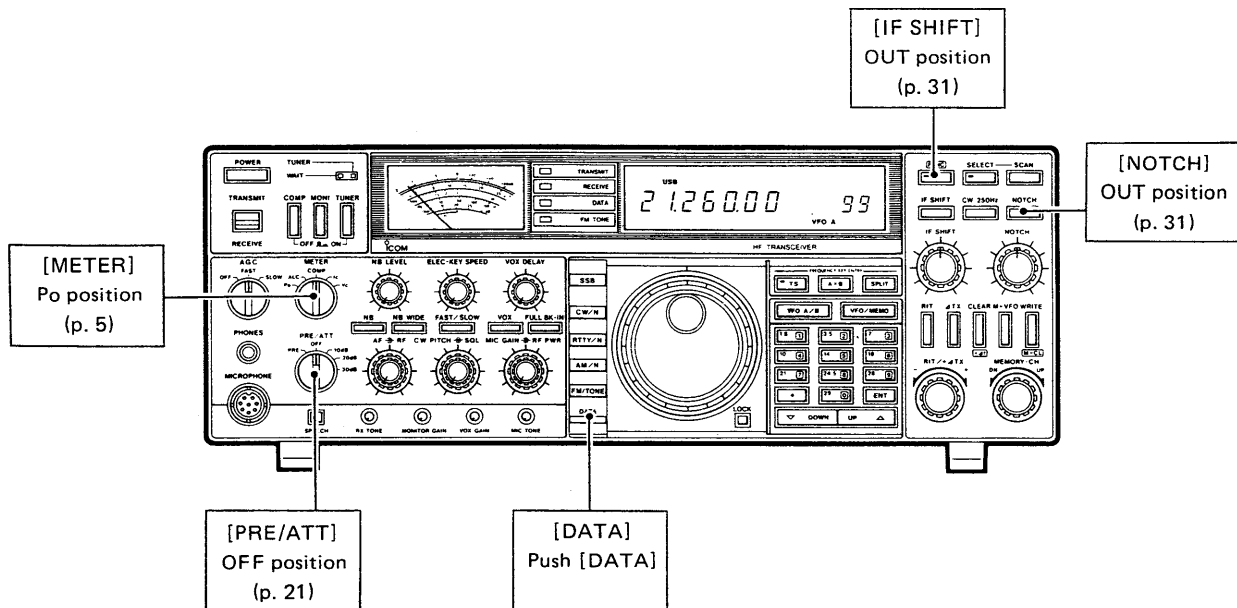

(1) RECEIVING

- 1) Connect a terminal unit as described on p. 14.
- 2) Set controls and switches as described on p. 19.
- 3) Push [POWER] IN.
- 4) Select the desired operating mode and see each section for the selected mode.

(2) TRANSMITTING

- 1) Set [METER] to the [Po] position to view relative output power on the meter.
- 2) Push [DATA].
 - [DATA] indicator lights.
 - Microphone input is inhibited except when the PTT switch on the microphone is pushed.
- 3) Type using your terminal unit keyboard.
 - The transceiver automatically transmits and the meter needle indicates a point, moving slightly according to data.
- 4) Adjust [RF PWR] to the desired output power level.

Tech Talk from Icom

Q. What is packet radio?

- A. Packet radio is a highly advanced method of communications that provides digital (data) communications to radio amateurs. Packet radio provides high speed transmissions and effective networking and error checking.

CMSA/CD (Carrier-Sense Multiple Access with

Collision Detection) controls a packet radio station by preventing transmission when a frequency is busy. The system also allows many stations on the same frequency at the same time.

To operate using packet radio you need a transceiver, a computer equipped with an RS-232C I/O port, and a TNC (Terminal Node Controller).

Packet radio can send character messages typed from a computer keyboard or computer software data stored on a floppy disk.

7-1 IF SHIFT OPERATION

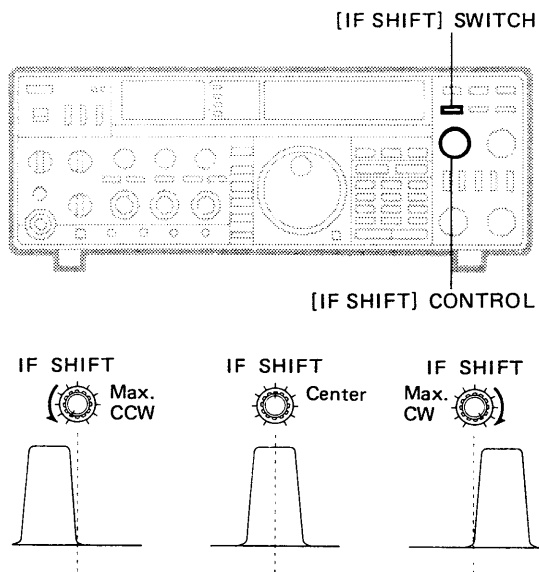

IF Shift Tuning is a system designed to electronically shift the passband of frequencies that pass through the receiver crystal filter.

The IF Shift Tuning is used to reduce interference from adjacent frequency signals.

- 1) Push the [IF SHIFT] switch.
- 2) Rotate the [IF SHIFT] control either clockwise or counterclockwise to eliminate interference.

NOTE: IF Shift Tuning does not function in AM and FM modes.

7-2 NOTCH FILTER OPERATION

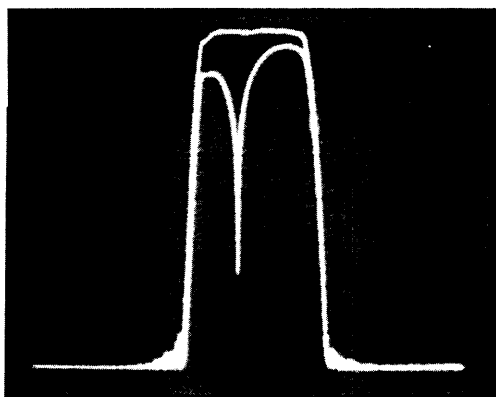

The Notch Filter attenuates a particular frequency in the IF passband, such as that of an interfering signal.

- 1) Push the [NOTCH] switch.
- 2) Rotate the [NOTCH] control to minimize interference.

CENTER:
9.0115 MHz
SPAN : 10 kHz
SWP : 500 ms
PBW : 300 Hz
VBW : 300 Hz
REF : 10 dB/div

7-3 AGC OPERATION

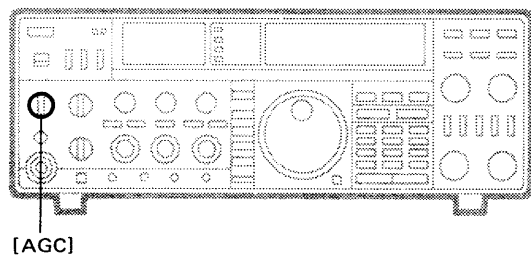

The IC-765 has a fast attack and slow release AGC system. The transceiver maintains the peak voltage of the rectified IF signal from the IF amplifier for a brief period of time.

OFF position:

Used when receiving a very weak signal. In this case, the [RF] gain control is useful for reducing receiver gain.

- The S-meter does not function in the OFF position.

FAST position:

Normally used when receiving a signal with short interval fading. Especially effective in CW or RTTY mode.

SLOW position:

Normally used when receiving a signal in SSB or AM mode.

- AGC holds audio output constant during fluctuations in signal strength. It keeps irritating background noise from being heard during the short pauses in speech.

NOTE: The [AGC] switch does not function in FM mode.

7-4 NOISE BLANKER OPERATION

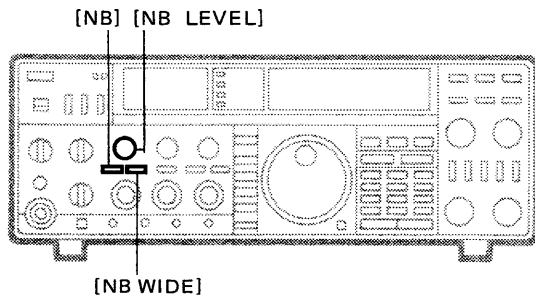

The noise blanker effectively reduces interference from pulse-type noise such as car ignitions and wide pulse-type noise known as "woodpecker" noise.

- 1) Push the [NB] switch IN.
- 2) Adjust the [NB LEVEL] control as required depending on the noise level.

NOTE: If the noise blanker distorts the audio of a received signal, rotate the [NB LEVEL] control counterclockwise as required.

- 3) To suppress "woodpecker" noise and other wide pulse-type noise, push both the [NB] and [NB WIDE] switches IN.

7-5 VOX OPERATION

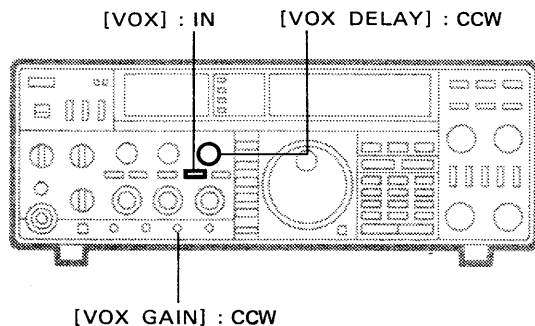

VOX (voice-operated relay) operation lets you key the transmitter to your voice.

- 1) Set the front panel controls as shown at left.
- 2) While speaking naturally into the microphone, rotate the [VOX GAIN] control clockwise until you key the transmitter.
- 3) To adjust the transmit-to-receive switching time, adjust and [VOX DELAY] control.
- 4) To prevent speaker audio from tripping the VOX, adjust the [ANTI-VOX] control located under the hatch cover.

7-6 ANTENNA TUNER OPERATION

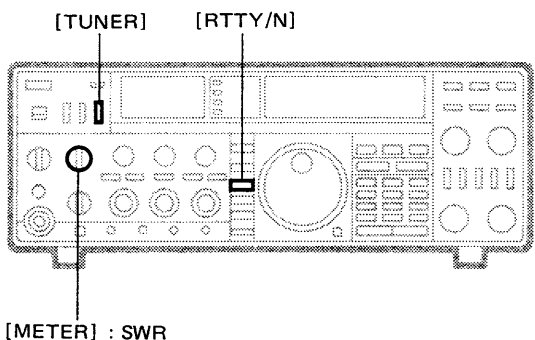

This tuner matches the IC-765 to an antenna including the feedline when its SWR is less than 3:1 (impedance 16.7 ~ 150 Ω).

- 1) Push the [TUNER] switch IN.
- 2) Set the [METER] switch to the [SWR] position.
- 3) Push the [RTTY/N] switch to select RTTY mode.
 - This is for continuously transmitting RF power.
- 4) Set the frequency on which you plan to operate.
- 5) Set the [RF PWR] control to the 9 o'clock position for an output of more than 10 W.
- 6) Transmit for several seconds.
 - The [WAIT] indicator lights while the tuner is matching.
 - When the [WAIT] indicator goes out, the tuner matches at 50 Ω.
 - When the [WAIT] indicator blinks, the tuner has not lowered the SWR. Re-adjust the antenna.
- 7) Verify the SWR on the meter, then stop transmitting.

7 FUNCTIONS OPERATION

7-7 SPEECH COMPRESSOR OPERATION

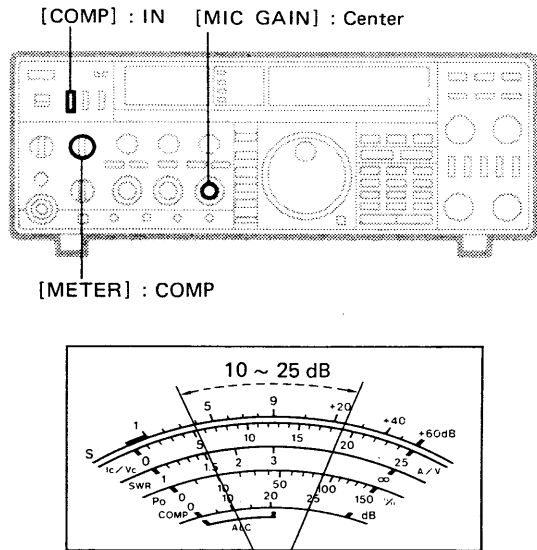

The RF speech compressor increases average output power, improving signal strength and intelligibility in SSB.

- 1) Set the front panel controls as shown at left.
- 2) Set the transceiver in transmitting.
- 3) Speak naturally into the microphone and adjust the [RF PWR] control as desired.
- 4) Push the [COMP] switch IN.
- 5) Adjust the [MIC GAIN] control for a COMP scale reading between 10 dB and 25 dB.

7-8 MONITOR OPERATION

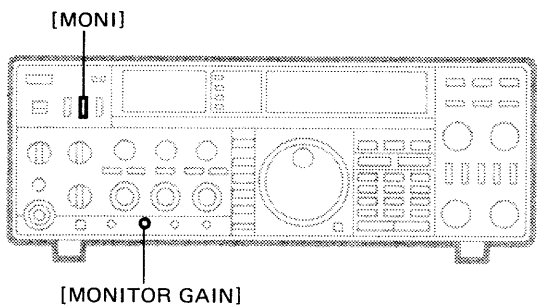

The monitor lets you hear IF signals in any mode through the speaker. The CW monitor always functions.

- 1) Push the [MONI] switch IN.
- 2) Adjust the [MONITOR GAIN] control as desired while transmitting.

NOTE: Wear headphones to prevent feedback.

7-9 SWR READING

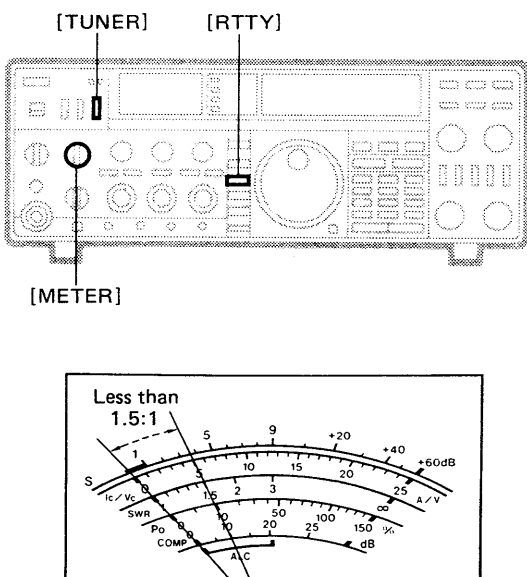

The SWR meter functions in all modes.

- 1) Push the [TUNER] switch OUT to turn the antenna tuner OFF.
- 2) Set the [METER] switch to the [Po] position.
- 3) Push the [RTTY/N] switch.
- 4) Set the transceiver in transmit mode.
- 5) Rotate the [RF PWR] control clockwise past 12 o'clock for an output of at least 30 W.
- 6) Set the [METER] switch to the [SWR] position.
- 7) Read the SWR on the SWR scale.

NOTE: The built-in antenna tuner matches the transmitter to the antenna when the SWR is lower than 3:1.

7-10 SPLIT (DUPLEX) OPERATION

(1) SETTING SPLIT FREQUENCIES

[EXAMPLE]

Set the frequency for split (duplex) operation on 7.05700 MHz/CW (receive) and 7.02500 MHz/CW (transmit).

- 1) Set the frequency and mode for 7.05700 MHz/CW in VFO A and for 7.02500 MHz/CW in VFO B respectively.

VFO A

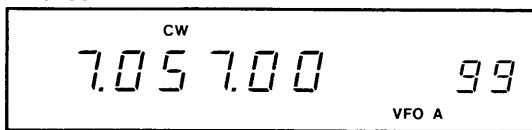

VFO B

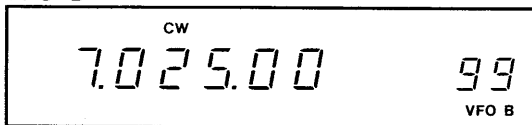

- 2) Push the [VFO A/B] switch to display the VFO A frequency.

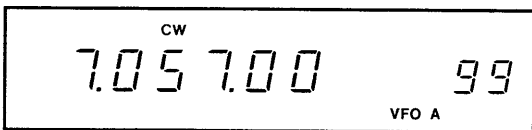

- 3) Push the [SPLIT] switch.
 - "SPLIT" lights.

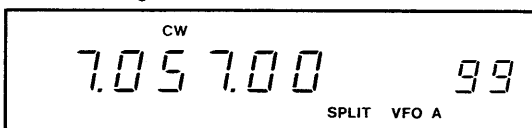

- 4) Set the transceiver in transmitting.
 - Receiving (VFO A) : 7.05700 MHz/CW
 - Transmitting (VFO B) : 7.02500 MHz/CW
- 5) To exchange frequencies, push the [VFO A/B] switch.
 - "VFO B" is displayed.

NOTE: During crossband split operation the [TUNER] switch should be OFF because the antenna tuner functions for the transmit frequency and reduces the sensitivity of the receive frequency.

Split (duplex) operation refers to transmitting and receiving on separate frequencies.

(2) MEMORIZING SPLIT FREQUENCIES

Memory channels 90 ~ 99 can memorize both receive and transmit frequencies. This is useful for selecting the most often used split frequencies.

[EXAMPLE]

Memorize split frequencies as set in item (1) at left into memory channel 90.

- 1) Make sure that the following information is set:
 - Function display in VFO A: 7.05700 MHz/CW
 - Function display in VFO B: 7.02500 MHz/CW
 - "SPLIT" lights.

- 2) Push the [VFO A/B] switch to display VFO A.

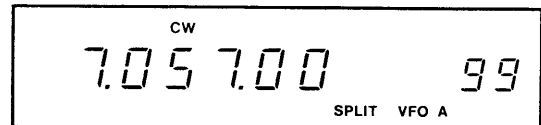

- 3) Rotate the [MEMORY-CH] selector to set memory channel 90 in VFO mode.

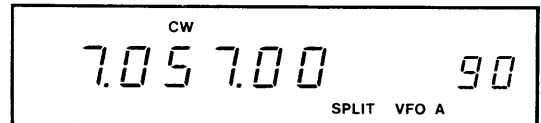

- 4) To store the information, push and hold the [WRITE] switch until the speaker emits 3 beep tones.

(3) USING THE STORED FREQUENCIES

[EXAMPLE]

When information in memory channel 90 is used for split operation.

- 1) Select MEMORY mode and memory channel 90.
- 2) Push the [SPLIT] switch.
 - "SPLIT" lights.

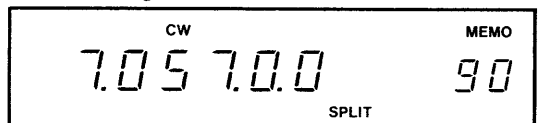

- 3) Set the transceiver in transmitting.
 - Transmit frequency appears.
 - You are receiving on 7.05700 MHz/CW and transmitting on 7.02500 MHz/CW.

7-11 RIT/ Δ TX OPERATION

RIT and Δ TX functions are useful for shifting display frequencies independently.

(1) RIT OPERATION

RIT shifts the receive frequency by up to ± 9.99 kHz in 10 Hz steps without shifting the transmit frequency.

- 1) Push the [RIT] switch.
 - "RIT" and the shift frequency appear.



- 2) To shift the receive frequency, rotate the [RIT/ Δ TX] control.
 - The shift frequency changes.

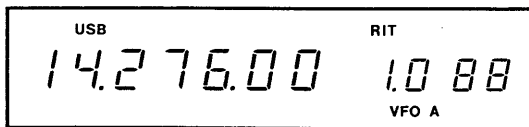

- 3) To turn OFF the RIT, push the [RIT] switch again.
 - "RIT" and the shift frequency disappear.
 - The last shift frequency displayed is stored.
- 4) To display the last shift frequency, push the [RIT] switch.
 - "RIT" and the stored shift frequency appear.
- 5) To add the shift frequency to the operating frequency, push the [FUNC] switch, then push and hold the [CLEAR] switch until the speaker emits 3 beep tones.
 - The shift frequency is added to the operating frequency.

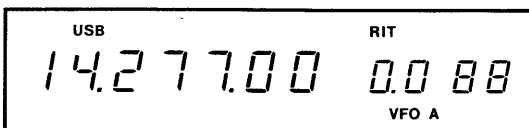

- 6) To clear the shift frequency, push the [CLEAR] switch.
 - The shift frequency resets to "0.0".

(2) Δ TX OPERATION

Δ TX shifts the transmit frequency by up to ± 9.99 kHz in 10 Hz steps without shifting the receive frequency.

- 1) Push the [Δ TX] switch.
 - " Δ TX" and the shift frequency appear.



- 2) To shift the transmit frequency, rotate the [RIT/ Δ TX] control.
 - The shift frequency changes.

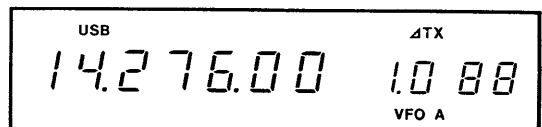

- 3) To turn OFF the Δ TX, push the [Δ TX] switch again.
 - " Δ TX" and the shift frequency disappear.
 - The last shift frequency displayed is stored.
- 4) To display the last shift frequency, push the [Δ TX] switch.
 - " Δ TX" and the stored shift frequency appear.
- 5) To add the shift frequency to the operating frequency, push the [FUNC] switch, then push and hold the [CLEAR] switch until the speaker emits 3 beep tones.
 - The shift frequency is added to the operating frequency.

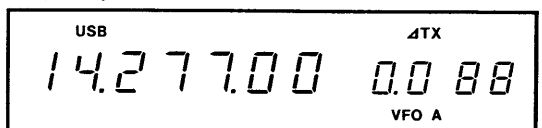

- 6) To clear the shift frequency, push the [CLEAR] switch.
 - The shift frequency resets to "0.0".

7-12 FREQUENCY EQUALIZING OPERATION

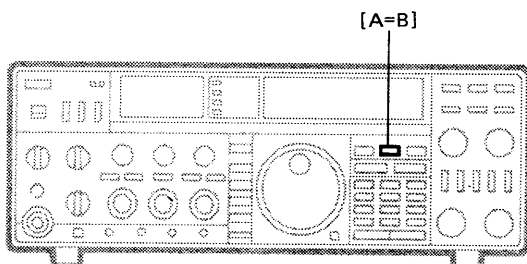

This function instantly matches the frequency and mode of operation of the 2 VFOs.

- 1) Push the [VFO/MEMO] switch to select VFO mode.
- 2) Push and hold the [A=B] switch until the speaker emits 3 beep tones.
 - Contents of VFO A and VFO B are the same.
 - The display frequency does not change.
- 3) To check the equalizing process, push the [VFO A/B] switch.

8-1 MEMORY CHANNELS

The IC-765 has 101 memory channels for memory channels 1 ~ 99, P1 and P2. Each memory channel has special capabilities as shown in the following table:

MEMORY CHANNEL NUMBER	CAPABILITY
1 ~ 89	One frequency and one mode in each memory channel.
90 ~ 99	Independent transmit and receive frequencies and mode on each channel for split operation. NOTE: It is possible to use these channels as normal memory channels.
P1 and P2	One frequency and one mode on each memory channel as scan edges of Programmed Scan.

8-2 VFO AND MEMORY MODE SELECTION

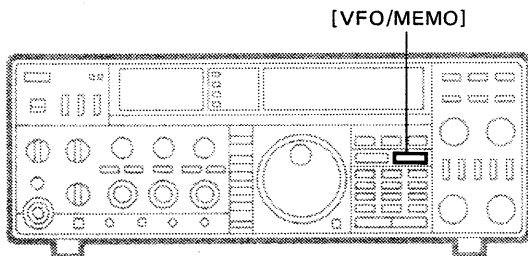

Pushing the [VFO/MEMO] switch each time alternately selects VFO and MEMORY mode.

• VFO mode

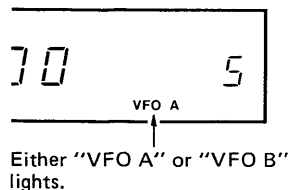

• MEMORY mode

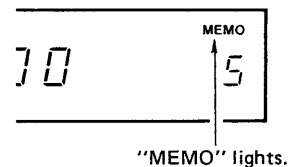

8-3 MEMORY READING

(1) SELECTING A MEMORY CHANNEL

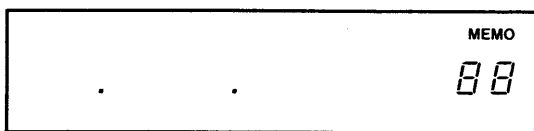

- 1) Push the [VFO/MEMO] switch to select MEMORY mode.
 - "MEMO" lights.
- 2) Rotate the [MEMORY-CH] selector to select a desired memory channel.
 - When memory channels not yet programmed are selected, only the decimal points appear.
- 3) To select only the selected memory channels, push the [SELECT] switch. See item (2) below for programming.

(2) PROGRAMMING A MEMORY CHANNEL AS A SELECTED MEMORY CHANNEL

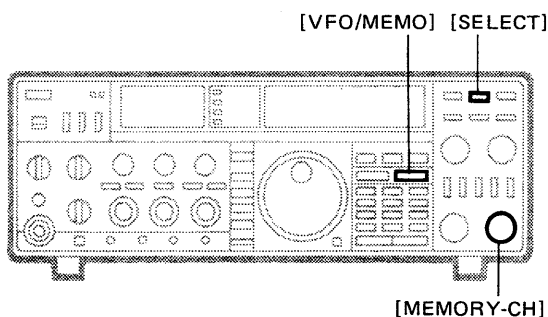

When programming a memory channel as a selected memory channel, only the selected memory channels are recalled.

- 1) Push the [VFO/MEMO] switch to select MEMORY mode.
- 2) Rotate the [MEMORY-CH] selector to select a desired memory channel you want to program as a selected memory channel.
- 3) Push the [SELECT] switch.
 - The green indicator lights up, indicating that the channel is a selected memory channel.
- 4) To cancel the selected memory channel, push the [SELECT] switch again.

8 MEMORY CHANNEL OPERATION

8-4 MEMORY WRITING

(1) MEMORY WRITING

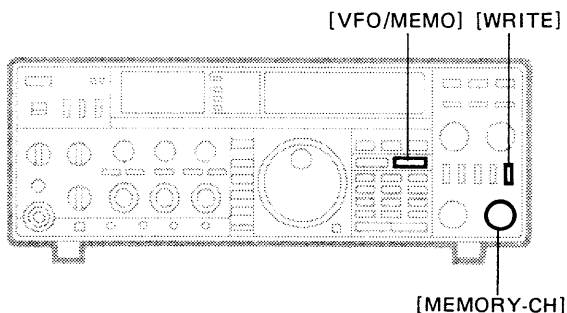

Use to store the displayed operating frequency into a memory channel when you are operating in VFO mode.

- 1) Push the [VFO/MEMO] switch to select VFO mode.
 - Either VFO A or VFO B is acceptable.
- 2) Set the desired frequency and mode.
- 3) Rotate the [MEMORY-CH] selector to select the memory channel you want to store.
- 4) Push and hold the [WRITE] switch until the speaker emits 3 beep tones.
 - The information is stored.

[EXAMPLE]

Store 14.2300 MHz and USB into memory channel 20.

- 1) Select VFO mode.
- 2) Set the frequency and mode for 14.2300 MHz/USB.

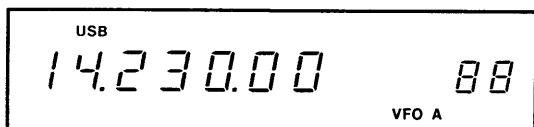

- 3) Select memory channel 20.

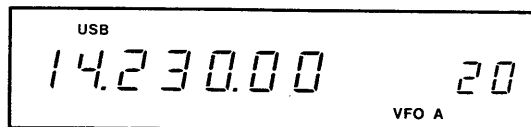

- 4) Push and hold the [WRITE] switch.

(2) CHANGING MEMORY CONTENTS

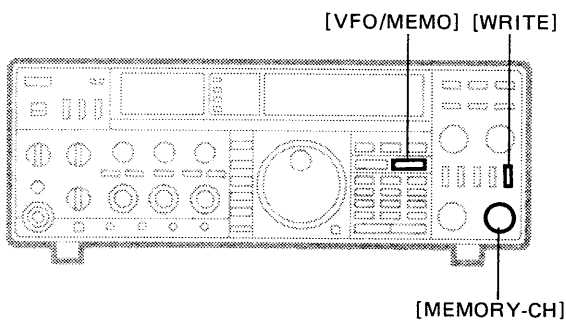

Use to change the displayed memory frequency when you are operating in MEMORY mode.

- 1) Push the [VFO/MEMO] switch to select MEMORY mode.
- 2) Rotate the [MEMORY-CH] selector to select the memory channel you want to change or operate.
- 3) Set the desired frequency and mode.
- 4) Push and hold the [WRITE] switch until the speaker emits 3 beep tones.
 - The information is changed.

[EXAMPLE]

Change the memory channel contents in memory channel 20 from 14.2300 MHz and USB to 14.0300 MHz and CW.

- 1) Select MEMORY mode.
- 2) Select memory channel 20.

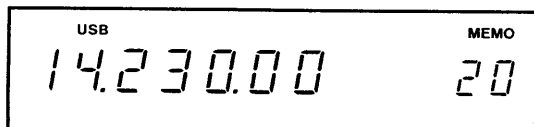

- 3) Set the frequency for 14.0300 MHz/CW.

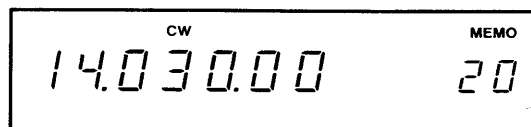

- 4) Push and hold the [WRITE] switch.

8-5 MEMORY TRANSFERRING

(1) IN VFO MODE

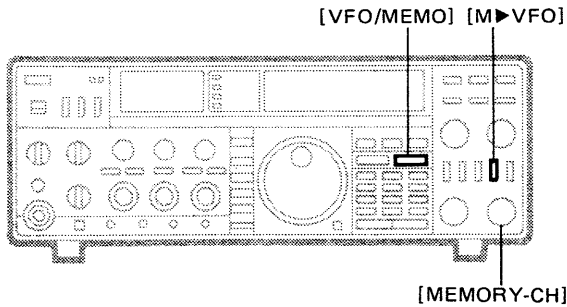

The selected memory contents in a memory channel can be transferred to a VFO. Follow the steps below (1) for memory transferring in VFO mode or (2) for memory transferring in MEMORY mode.

The frequency and mode stored in the displayed memory channel are transferred to a selected VFO.

- 1) Rotate the [MEMORY-CH] selector to select the desired memory channel you want to read when operating in VFO mode.
- 2) Push and hold the [M▶VFO] switch until the speaker emits 3 beep tones.
 - The information is transferred to a VFO.

(2) IN MEMORY MODE

The displayed frequency and mode are transferred to the VFO used immediately prior to changing to MEMORY mode.

- 1) Rotate the [MEMORY-CH] selector to select the desired memory channel you want to read when operating in MEMORY mode.
- 2) Push and hold the [M▶VFO] switch until the speaker emits 3 beep tones.
 - The information is transferred to a VFO.
- 3) Push the [VFO/MEMO] switch to select VFO mode.
 - The transferred memory contents are displayed.

8-6 MEMORY CLEARING

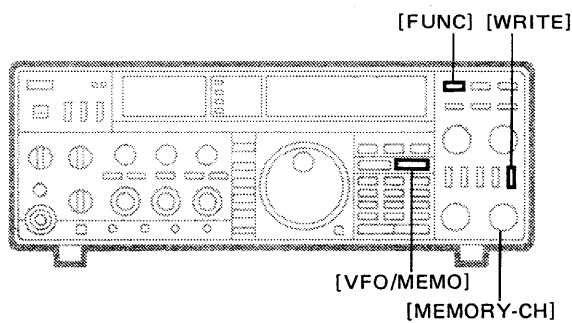

This function clears the information in each memory channel.

- 1) Push the [VFO/MEMO] switch to select MEMORY mode.
- 2) Rotate the [MEMORY-CH] selector to select a memory channel to be cleared.
- 3) Push the [FUNC] switch.
- 4) Push and hold the [WRITE] switch until the speaker emits 3 beep tones.
 - The memory channel is now cleared.

[EXAMPLE]

Clear contents of memory channel 20.
 - Contents of memory channel 20: 14.0300 MHz/CW

- 1) Select MEMORY mode.
- 2) Select memory channel 20.

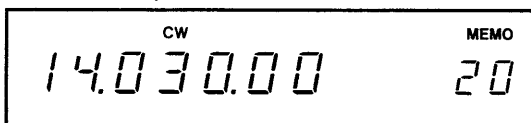

- 3) Push the [FUNC] switch.
- 4) Push and hold the [WRITE] switch.

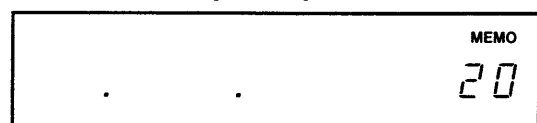

9-1 SCAN TYPES

The IC-765 is equipped with three scan functions.

SCAN NAME	FUNCTION
PROGRAMMED SCAN	Repeatedly scans between two user-programmed scan edges (P1 and P2).
MEMORY SCAN	Repeatedly scans all memory channels.
SELECTED MEMORY SCAN	Repeatedly scans selected memory channels. The green indicator lights up when the channel is selected.

9-2 PROGRAMMED SCAN

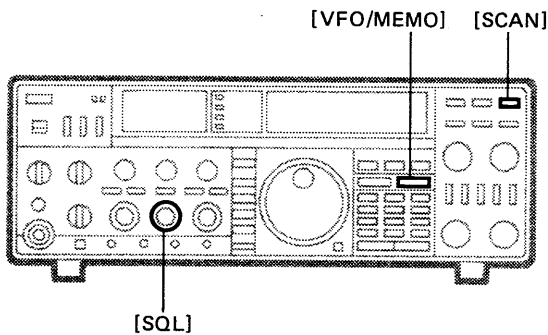
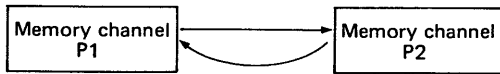

1) Program the desired frequencies into memory channels P1 and P2. See p. 37 for programming memory channels.

• Memory channel P1



• Memory channel P2

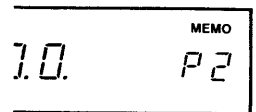

2) Push the [VFO/MEMO] switch to select VFO mode.

3) Select LSB, USB, CW, RTTY, AM or FM mode.

4) Adjust the [SQL] control to the threshold point.

- The green [RECEIVE] indicator goes out.

5) Push the [SCAN] switch to start the scan.

- "SCAN" lights.
- The scan stops when a receive signal opens the squelch.
- The scan resumes after the signal disappears.

6) To change the scan speed or scan resumption, see Section 11 - 5.

7) Push the [SCAN] switch again to cancel the scan.

- Some switches as shown in the diagram below also stop the scan.

• The following switches and control stop the scan.

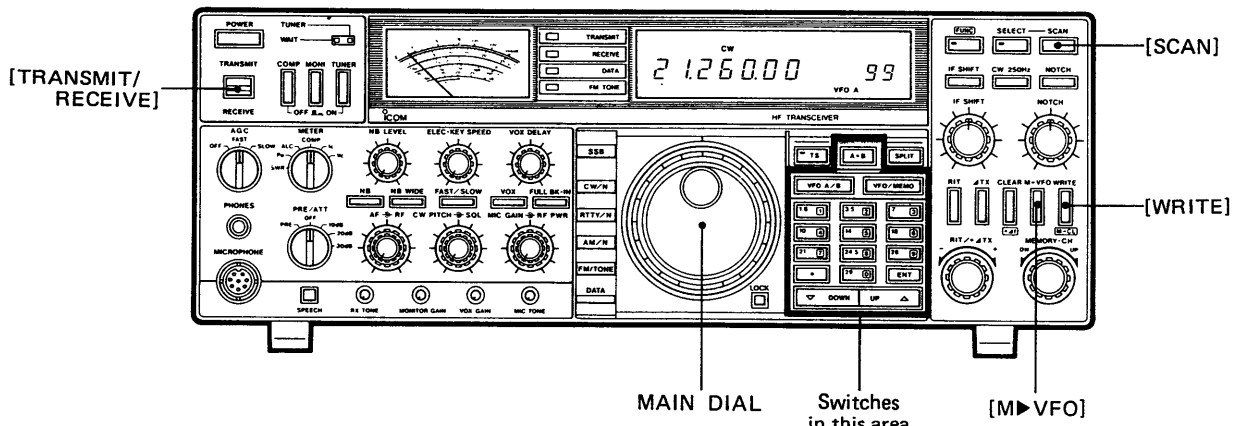

9-3 MEMORY SCAN

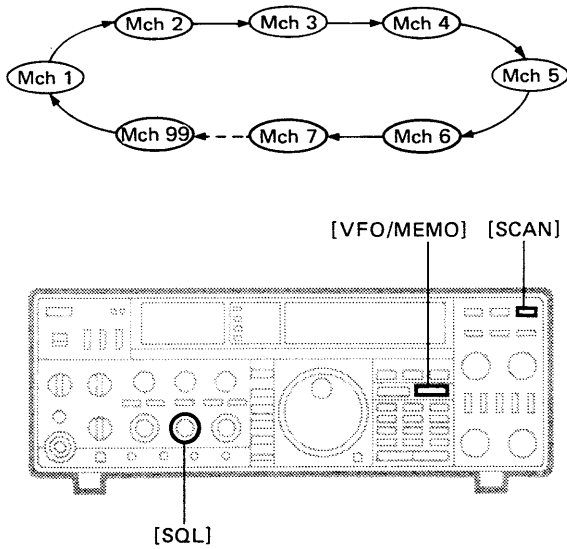

- 1) Program the desired frequencies into memory channels. See p. 37 for programming memory channels.
- 2) Push the [VFO/MEMO] switch to select MEMORY mode.
- 3) Adjust the [SQL] control to the threshold point.
 - The green [RECEIVE] indicator goes out.
- 4) Push the [SCAN] switch.
 - "SCAN" lights.
 - The scan stops when a receive signal opens the squelch.
 - The scan resumes after the signal disappears.
- 5) To change the scan speed or scan resumption, see Section 11 - 5.
- 6) Push the [SCAN] switch again to cancel the scan.
 - Some switches also stop the scan. See the diagram on p. 39.

9-4 SELECTED MEMORY SCAN

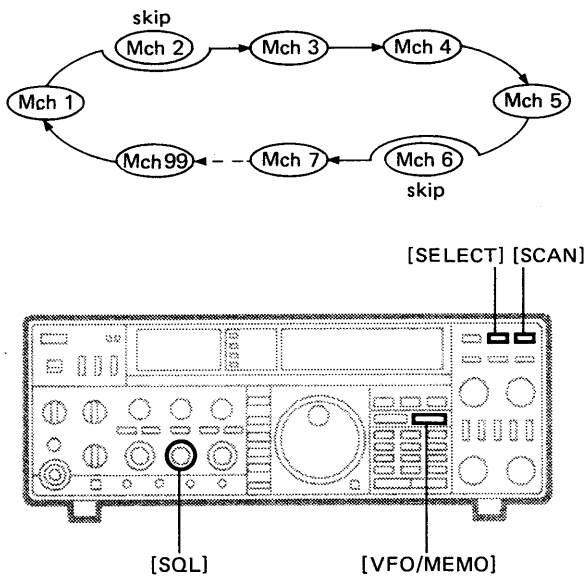

- 1) Program the desired frequencies into memory channels. See p. 37 for programming memory channels.
- 2) Program the desired memory channels for the selected memory channel. See p. 36 for Section 8 - 3 item (2).
- 3) Push the [VFO/MEMO] switch to select MEMORY mode.
- 4) Adjust the [SQL] control to the threshold point.
 - The green [RECEIVE] indicator goes out.
- 5) Push the [SCAN] switch to start the memory scan.
 - "SCAN" lights.
- 6) Then push the [SELECT] switch to start the selected memory scan.
 - The scan stops when a receive signal opens the squelch.
 - The scan resumes after the signal disappears.
- 7) To change the scan speed or scan resumption, see Section 11 - 5.
- 8) To change the scan from the selected memory scan to the memory scan, push the [SELECT] switch again.
- 9) To cancel the scan, push the [SCAN] switch again.
 - Some switches also stop the scan. See the diagram on p. 39.

10 MAINTENANCE

10-1 TRANSCEIVER DISASSEMBLY

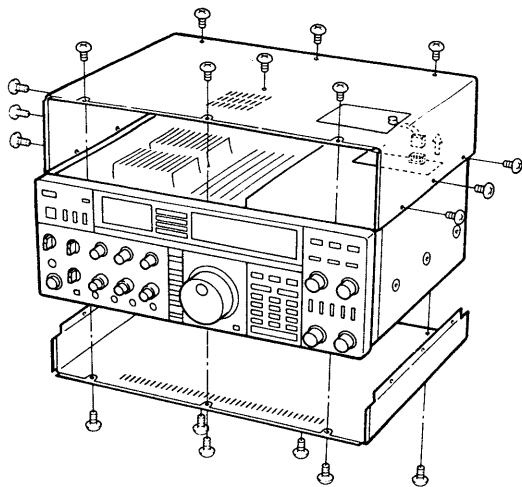

WARNING: DISCONNECT the AC power cable from the transceiver before performing any work on the transceiver.

- 1) Turn the [POWER] switch OFF.
- 2) Disconnect the AC power cable.
- 3) Unscrew screws as shown in the diagram at left.
- 4) Remove the top cover slowly and unplug the speaker connector.
- 5) Remove the bottom cover.

10-2 FUSE REPLACEMENT

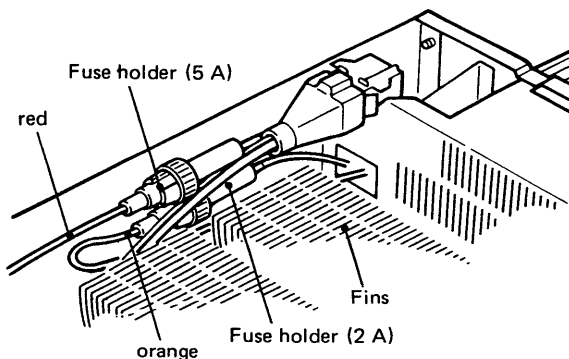

If the fuse blows or the transceiver stops functioning, find the source of the problem if possible, and replace the damaged fuse with a new, rated fuse.

WARNING: Be careful. The fins of the POWER SUPPLY unit are very sharp.

- 3 fuses are installed in the transceiver:
- Rear panel AC line fuse holder : 10 A for 120 V AC
5 A for 220 ~ 240 V AC
 - Inside DC line fuse holders : See the diagram at left.

10-3 CPU RESETTING

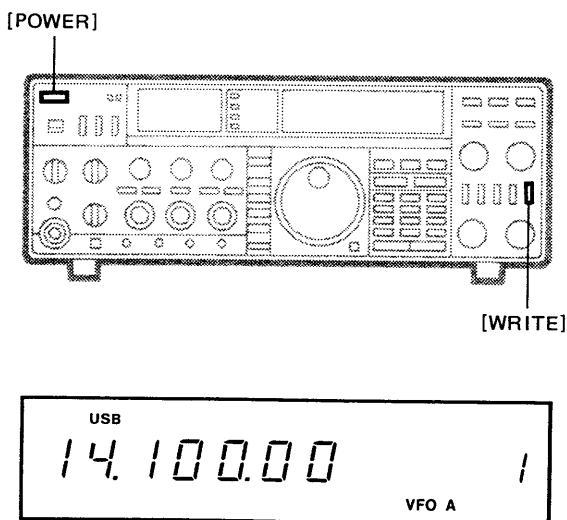

The frequency display may occasionally display erroneous information, e.g., when first applying power. This may be caused externally by static electricity or other factors.

If this problem occurs, turn the [POWER] switch OFF. Wait a few seconds, and then turn ON power again. If the problem continues, perform the following procedure:

CAUTION: CPU resetting clears all memory information.

- 1) Push the [POWER] switch OUT to turn OFF the power.
- 2) Push and hold the [WRITE] switch, and push the [POWER] switch IN to turn ON the power.
- 3) Release the switch.
 - When the frequency display shows the information shown at left, the CPU is reset.

10-4 CPU BACKUP BATTERY

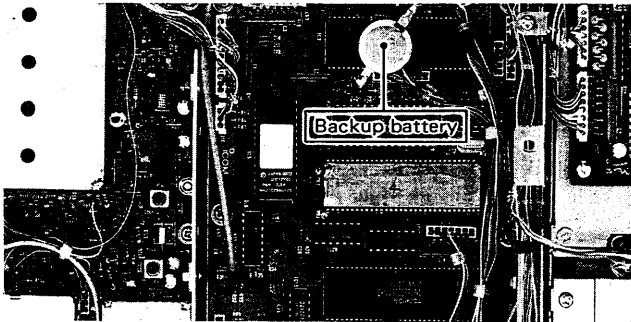

The CPU in the IC-765 includes an externally connected RAM IC chip for storing memory channel information. The information is retained by a lithium backup battery.

When the backup battery is exhausted, the transceiver transmits and receives normally but the transceiver cannot retain memory information.

CAUTION: Backup battery replacement should be done by an authorized Icom Dealer or Service Center.

10-5 CLEANING



If the transceiver becomes dusty or dirty, wipe it clean with a dry, soft cloth. Avoid the use of strong cleaning agents such as benzine or alcohol as they may damage the surfaces of the transceiver.

Tech Talk from Icom

Q. Why is a lithium battery usually used for memory backup?

A. Because the self-discharge of the lithium battery is very low compared to other batteries. This means the battery voltage or capacity decreases only a little even if the battery is left for several years without connection.

An interesting technical point is the life expectancy of the lithium battery on the LOGIC unit. Our lithium battery, BR2032-1T2, is rated at a 180 mAh capacity.

Icom has made calculations for the battery life in the worst case situation such as when the battery

current is 3 μ A. Therefore, the battery life is:

$$\begin{aligned} \text{Battery life} &= 180 \text{ mAh} \div 3 \mu\text{A} \\ &= 6000 \text{ hours (= 2500 days)} \\ &= \text{approx. 6 years} \end{aligned}$$

Actually, typical current value is less than 0.5 μ A when the battery is connected to the LOGIC circuit in the IC-765 under normal conditions.

$$\begin{aligned} \text{Battery life} &= 180 \text{ mAh} \div 0.5 \mu\text{A} \\ &= 360000 \text{ hours (= 15000 days)} \\ &= \text{approx. 41 years} \end{aligned}$$

When the transceiver is turned ON, the lithium battery is deactivated. Therefore, the more you operate your IC-765, the longer the life of the lithium battery will be. In a way, the IC-765 gets stronger the more you operate it.

10-6 TROUBLESHOOTING

The following chart is designed to help you correct problems which are not equipment malfunctions.

If you are not able to locate the cause of a problem or solve it through the use of this chart, contact your nearest Icom Service Center or Dealer.

(1) RECEIVING AND TRANSMITTING

PROBLEM	POSSIBLE CAUSE	SOLUTION	REF.
1. Power does not come on when [POWER] is pushed.	<ul style="list-style-type: none"> • Power cable is improperly connected. • Power cable is cut. • Fuse is blown. Fuses are installed in 3 places: <ul style="list-style-type: none"> - in the rear panel fuse holder. - inside the transceiver. (2 fuses) 	<ul style="list-style-type: none"> • Reconnect the power cable securely. • Check the cable continuity. • Check for the cause, then replace the fuse with a spare one. 	p. 41
2. No sound comes from the speaker or volume is too low.	<ul style="list-style-type: none"> • Volume level is too low. • The squelch is closed. • The transceiver is in transmit mode. • An external speaker or headphones are in use. 	<ul style="list-style-type: none"> • Rotate [AF] CW to obtain a suitable listening level. • Rotate [SQL] CCW to open the squelch. • Set the [TRANSMIT/RECEIVE] switch to RECEIVE or check SEND line of the external unit, if connected. • Check the external speaker or headphones plug connection. 	p. 22 p. 22 p. 23 p. 12
3. Sensitivity is low.	<ul style="list-style-type: none"> • The antenna feedline is cut or shorted. • Attenuator is inserted. • [RF] is rotated CCW. 	<ul style="list-style-type: none"> • Check the feedline and correct any improper conditions. • Set [PRE/ATT] to the OFF position or disconnect the external attenuator, if connected. • Rotate [RF] max. CW. 	p. 11 p. 21 p. 22
4. S-meter does not move.	<ul style="list-style-type: none"> • [AGC] is set in the [OFF] position. • [RF] is rotated CCW. 	<ul style="list-style-type: none"> • Set [AGC] in the [FAST] or [SLOW] position. • Rotate [RF] CW. 	p. 31 p. 22
5. Received audio is unclear or distorted.	<ul style="list-style-type: none"> • [AGC] is set in the [OFF] position. • [NB] is ON and [NB LEVEL] is rotated too far CW. • Wrong MODE switch is selected. • [IF SHIFT] control is rotated too far CW or CCW. • [CW PITCH] control is rotated too far CW or CCW when operating in CW mode. 	<ul style="list-style-type: none"> • Set [AGC] in the [FAST] or [SLOW] position. • Push [NB] OUT or rotate [NB LEVEL] CCW. • Push the correct MODE switch. • Rotate [IF SHIFT] control to the center position. • Rotate [CW PITCH] to the center position. 	p. 31 p. 32 pgs. 25~29 p. 31 p. 22
6. No output power or the output is too low.	<ul style="list-style-type: none"> • The operating frequency is outside an amateur band. • [RF PWR] is rotated too far CCW. • [MIC GAIN] is rotated too far CCW in SSB mode. • Antenna SWR is very high. 	<ul style="list-style-type: none"> • Select a frequency in an amateur band. • Rotate [RF PWR] CW. • Rotate [MIC GAIN] CW. • Push [TUNER] IN and transmit to match with the antenna. 	p. 20 p. 24 p. 23 p. 33
7. Transmitted signal is unclear or distorted.	<ul style="list-style-type: none"> • [MIC GAIN] is rotated too far CW. • [COMP] is pushed IN and the adjustment is not proper. 	<ul style="list-style-type: none"> • Rotate [MIC GAIN] CCW until the ALC meter needle is within the ALC zone. • Rotate [MIC GAIN] CCW until the COMP meter needle is within the 10 ~ 25 dB range. 	p. 23 p. 33
8. VOX function does not operate.	<ul style="list-style-type: none"> • [DATA] is pushed IN. 	<ul style="list-style-type: none"> • Push [DATA] OUT. 	p. 30
9. No contact is possible with another station.	<ul style="list-style-type: none"> • Transmit and receive frequencies are not the same. 	<ul style="list-style-type: none"> • Push [RIT] or [ΔTX] to turn OFF the functions. 	p. 35
10. Antenna tuner does not function.	<ul style="list-style-type: none"> • Antenna SWR exceeds 3:1. • RF power is not transmitted for tuning the antenna tuner. 	<ul style="list-style-type: none"> • Re-adjust your antenna. • Push [RTTY] for continuously transmitting RF power. 	p. 32 p. 32

CW: Clockwise CCW: Counterclockwise

(2) FREQUENCY SETTING

PROBLEM	POSSIBLE CAUSE	SOLUTION	REF.
1. Main dial does not function.	<ul style="list-style-type: none"> • [LOCK] is pushed IN. 	<ul style="list-style-type: none"> • Push [LOCK] OUT. 	p. 6
2. Frequency cannot be entered by the keyboard.	<ul style="list-style-type: none"> • [FUNC] is not pushed before digit keys are entered. • [ENT] is not pushed after digit keys are entered. • [.] is not pushed after 1 MHz digit is entered. 	<ul style="list-style-type: none"> • Push [FUNC] before entering a frequency via the keyboard. • Push [ENT] after entering a frequency via the keyboard. • Enter the 1 MHz digit then push [.] before entering the 100 kHz digit. 	<p>p. 20</p> <p>p. 20</p> <p>p. 20</p>
3. Frequency is changed when transmitting.	<ul style="list-style-type: none"> • The transceiver is set for split operation. 	<ul style="list-style-type: none"> • Push [SPLIT] OUT to cancel the operation. 	p. 34

(3) SCANNING

PROBLEM	POSSIBLE CAUSE	SOLUTION	REF.
1. Scan does not function.	<ul style="list-style-type: none"> • Squelch opens. • The transceiver is in transmit mode. 	<ul style="list-style-type: none"> • Set [SQL] to threshold point. • Set the transceiver in receive mode. 	pgs. 39, 40
2. Programmed scan does not function.	<ul style="list-style-type: none"> • Either P1 or P2 for scan edges is not programmed. 	<ul style="list-style-type: none"> • Program both P1 and P2. 	pgs. 37, 39
3. Memory scan does not function.	<ul style="list-style-type: none"> • No frequency is stored in memory channels. 	<ul style="list-style-type: none"> • Store more than 2 frequencies in memory channels. 	p. 40
4. Selected memory scan does not function.	<ul style="list-style-type: none"> • Memory channels are not programmed as a selected memory channel. 	<ul style="list-style-type: none"> • Program the desired memory channels for the selected memory channel. 	p. 40

(4) MEMORY OPERATION

PROBLEM	POSSIBLE CAUSE	SOLUTION	REF.
1. The frequency display indicates only decimal points when a memory channel is selected.	<ul style="list-style-type: none"> • No information is stored in the memory channel. 	<ul style="list-style-type: none"> • Store a desired frequency in the memory channel if needed. 	p. 37
2. Memory contents are not cleared.	<ul style="list-style-type: none"> • VFO mode is selected. 	<ul style="list-style-type: none"> • Select MEMORY mode with [VFO/MEMO]. 	p. 38
3. All programmed memories have been erased.	<ul style="list-style-type: none"> • Backup battery is exhausted. 	<ul style="list-style-type: none"> • Replace the backup battery. <p>CAUTION: The battery replacement should be done by an authorized Icom Dealer or Service Center.</p>	p. 42

(5) FUNCTION DISPLAY

PROBLEM	POSSIBLE CAUSE	SOLUTION	REF.
<ul style="list-style-type: none"> • The frequency display indicates erroneous information. 	<ul style="list-style-type: none"> • Internal CPU may have malfunctioned. 	<ul style="list-style-type: none"> • Reset the CPU. 	p. 41

11-1 BRAKE ADJUSTMENT

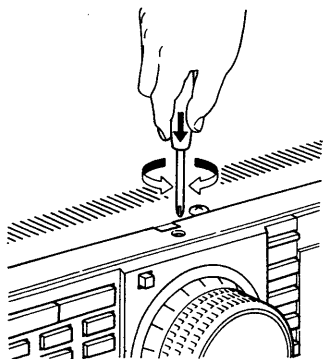

The tension of the main dial may be adjusted to suit your operating requirements.

- 1) Turn the transceiver upside down.
- 2) Turn the brake adjustment screw clockwise or counter-clockwise to a comfortable tension level while turning the main dial continuously and evenly in one direction.

11-2 SIMPLE FREQUENCY CALIBRATION

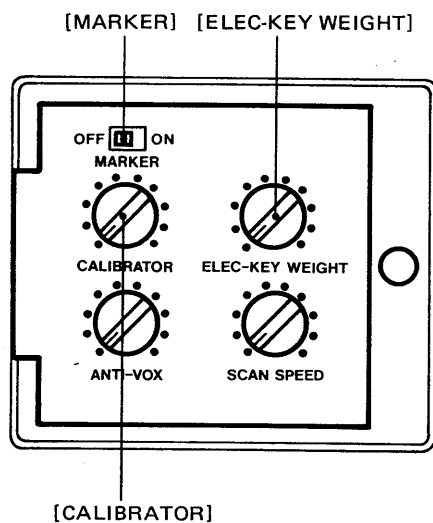

A very accurate frequency counter is required to calibrate the frequency of the IC-765. However, a simple check may be performed by receiving radio station WWV, or other standard frequency signals.

- 1) Push the [SSB] switch to select USB mode.
- 2) Set the frequency to the standard frequency station minus 1 kHz.

[EXAMPLE]

When receiving WWV (10.00000 MHz) as a standard frequency, set the display frequency for 9.99900 MHz.

The frequency is given:

$$10.00000 \text{ MHz} - 0.00100 \text{ MHz (1 kHz)} = 9.99900 \text{ MHz}$$

- 3) Slide the [MARKER] switch to the ON position. The switch is located under the hatch cover.
- 4) Adjust the [CALIBRATOR] control for making a zero beat with the received standard signal.
 - Zero beat means that two signals are exactly the same frequency, resulting in a single audio tone being emitted.

11-3 ELECTRONIC KEYS WEIGHT CONTROL

- 1) Connect an iambic key paddle to the [ELEC-KEY] jack on the rear panel. (See p. 12)
- 2) Push the [CW] switch.
- 3) Operate the paddle and adjust the [ELEC-KEY WEIGHT] control to suit your keying length. See the diagram in Section 11 - 2 for the control location.
 - The control is set at the factory for the DOT: SPACE: DASH ratio at 1:1:3. DOTS and DASHES increase in length when the control is turned clockwise.
 - See "Tech Talk from Icom" on p. 9 for details about the keying weight control.

11-4 TUNING SPEED DEFAULT SWITCH

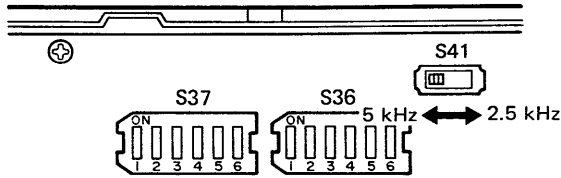

Normal rotation of the main dial changes the frequency increment for 5 kHz per full rotation in 10 Hz steps.

To change the frequency increment to 2.5 kHz from 5 kHz per full rotation, set S41 as shown in the diagram at left.

See p. 52 for the switch location.

11-5 SUPPLEMENTAL SCAN SETTINGS

(1) SCAN SPEED

The scan speed can be changed by the [SCAN SPEED] control located under the hatch cover.

(2) SCAN RESUMPTION

Set the switch to the desired position.

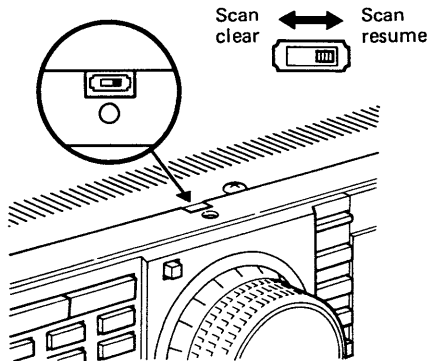

In the scan clear position:

The scan function can be automatically cleared when the transceiver receives a signal.

In the scan resume position:

The scan stops for approximately 10 seconds after the transceiver receives a signal, then resumes scanning.

11-6 RTTY DEFAULT SWITCHES

RTTY shift frequency and mark polarity can be changed with S2 and S3 on the MAIN unit. See the diagram at left.

The following mark/space frequencies and mark polarity are set at the factory.

- Mark frequency : 2125 Hz
- Space frequency : 2295 Hz
- Shift width : 170 Hz
- Mark polarity : key open
- Space polarity : key closed

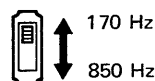
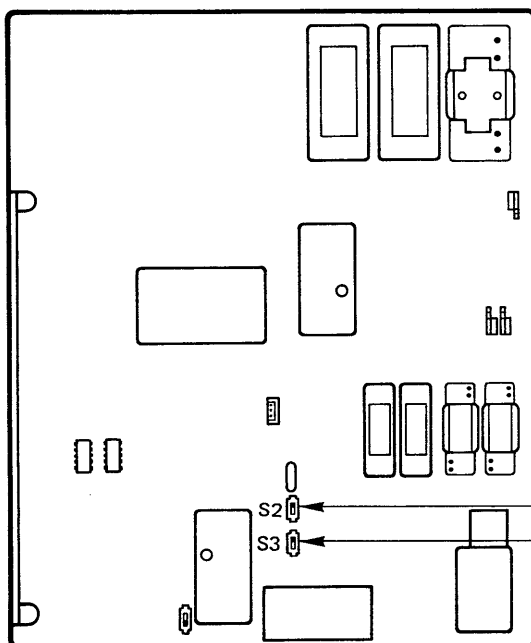

Shift width selector switch
Polarity selector switch

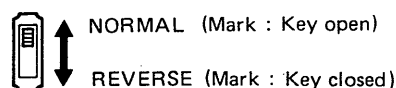

11 ADJUSTMENT

11-7 BFO ADJUSTMENT

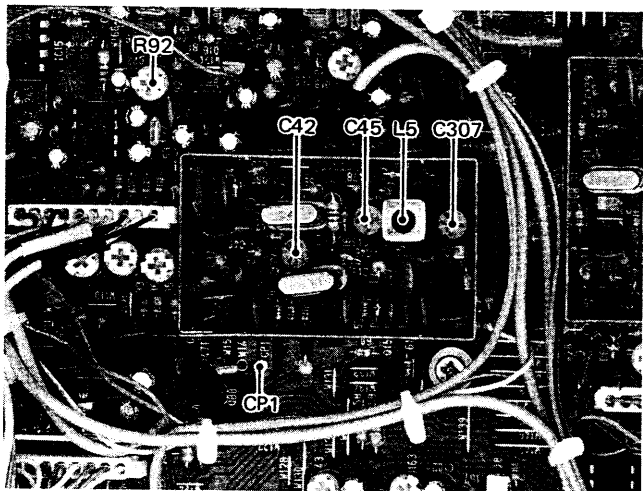

CAUTION: Your IC-765 has been thoroughly adjusted and checked at the factory before being shipped. Your transceiver warranty does not cover problems caused by unauthorized internal adjustments.

- 1) Connect a frequency counter to CP1 on the MAIN unit. See p. 52 for the area location.
- 2) Adjust trimmer capacitors and coil for the exact frequency as shown in the table.

NOTE: The [CW PITCH] control must be in the center position when adjusting for CW mode.

MODE	BFO FREQUENCY (MHz)		ADJUSTMENT POINT
	RECEIVE	TRANSMIT	
USB	9.01300	9.01300	C42
LSB	9.01000	9.01000	C45
CW	9.00990	No oscillation	C307
RTTY	9.008475	9.008475	L5
AM	No oscillation	9.01000	-----
FM	No oscillation	No oscillation	-----

11-8 BEEP VOLUME ADJUSTMENT

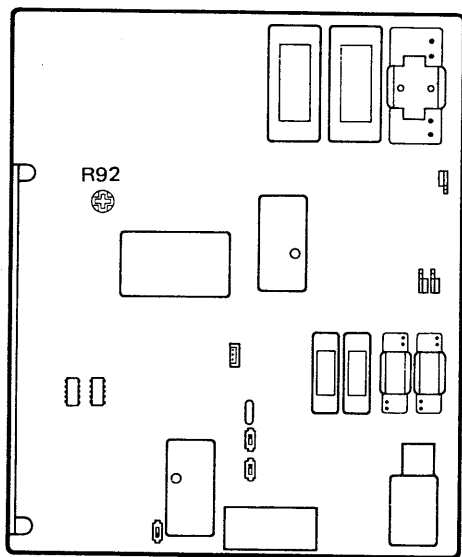

MAIN UNIT

Beep tone volume can be adjusted with R92 on the MAIN unit. Clockwise rotation increases the volume.

See the picture in Section 11 - 7 BFO ADJUSTMENT for the exact location of R92.

WARNING: To prevent electric shocks, disconnect the AC power cable from the AC outlet (receptacle) before performing any work on the transceiver.

12-1 UT-36 VOICE SYNTHESIZER UNIT

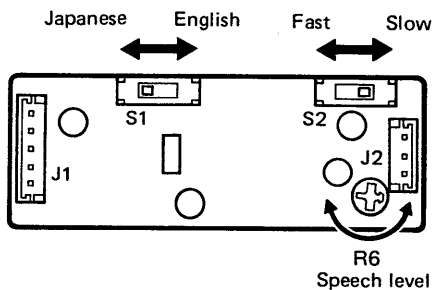
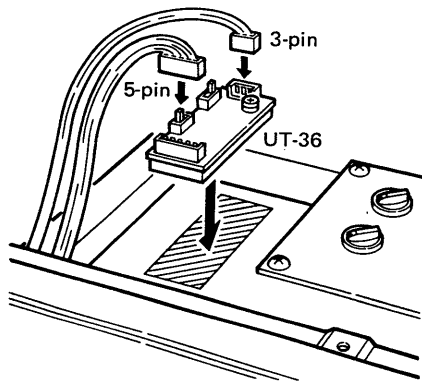

The voice synthesizer announces the operating frequency and mode when the [SPEECH] switch is pushed.

(1) INSTALLATION

- 1) Remove the protective paper from the back of the unit to expose the adhesive strip.
- 2) Install the unit to the proper position as shown in the diagram at left.
- 3) Connect the 5-pin plug from the LOGIC unit into J1 on the UT-36.
- 4) Connect the 3-pin plug from the MAIN unit into J2 on the UT-36.
- 5) Preset the control and switches if needed. See below.

(2) PRESETTING

- 1) The speaker emits the displayed frequency and mode each time when the [SPEECH] switch is pushed.
- 2) Preset S1 and S2 on the UT-36 as desired.
 - S1: Language selector switch
 - S2: Speech speed switch
- 3) Adjust R6 on the UT-36 to a suitable speech level.
 - The [AF] control on the front panel also varies the voice synthesizer speech level.

12-2 UT-30 PROGRAMMABLE TONE ENCODER UNIT

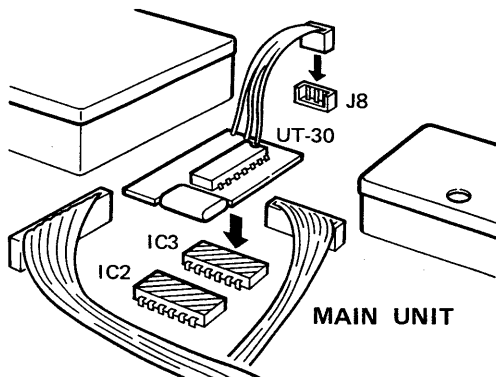

The tone encoder allows access to repeater stations that require subaudible tones superimposed on the transmit signal. The UT-30 has 38 programmable tones available.

- 1) Before installing the unit, program the unit for the frequency required using the chart supplied with the unit.
 - The unit is factory programmed for 88.5 Hz.
- 2) Remove the protective paper from the back of the unit to expose the adhesive strip.
- 3) Install the unit onto IC2 and IC3 on the MAIN unit as shown in the diagram at left.
- 4) Connect the 3-pin plug from the UT-30 into J8 on the MAIN unit.
- 5) See p. 29 for the operating instructions.

12-3 CR-282 HIGH-STABILITY CRYSTAL UNIT

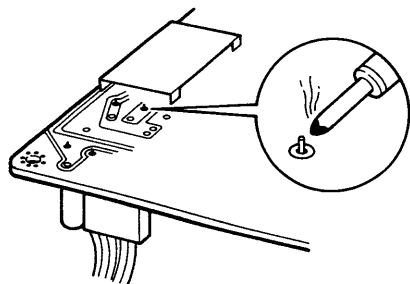
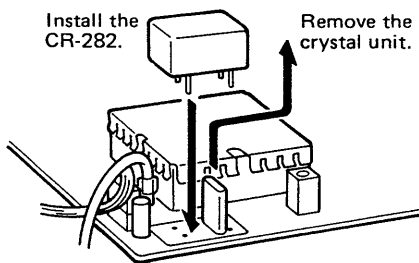
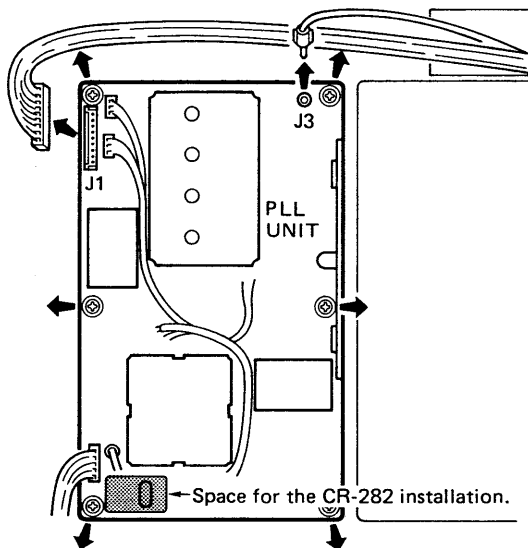
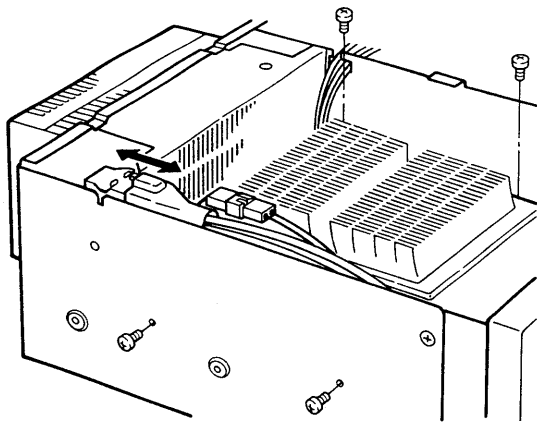

By replacing the original crystal unit with this unit, the total frequency stability of the transceiver will be improved.

CR-282 frequency stability:

± 0.5 ppm at $-30^{\circ}\text{C} \sim +60^{\circ}\text{C}$, $-22^{\circ}\text{F} \sim +140^{\circ}\text{F}$

- 1) Remove the top cover. See p. 41 for the transceiver disassembly instructions.
- 2) Disconnect the connector as shown at left.
- 3) Unscrew 4 screws as shown at left to remove the POWER SUPPLY unit from the transceiver.

WARNING: Please put on gloves when removing the POWER SUPPLY unit from the transceiver since the edges of the fins on the POWER SUPPLY unit are sharp.

- 4) Unplug connectors from J1 and J3 as shown at left.
- 5) Unscrew 6 screws as shown at left.
- 6) Take the P.C. board out of the transceiver.

- 7) Remove the X1 crystal unit from the P.C. board as shown at left.
- 8) Unsolder the 4 positions on the foil side of the P.C. board where the CR-282 will be installed. Use a de-soldering braid.
- 9) Install the CR-282 flush with the P.C. board and in the proper direction.
 - For correct installation, symbols on the bottom of the CR-282 must be identically matched with symbols on the P.C. board.
- 10) Bend the CR-282 leads flush with the foil side of the P.C. board and trim the leads. Then solder them.
- 11) Replace the P.C. board and covers.

12-4 FILTERS

The optional FL-53A, FL-101 and FL-102 are available. By installing a filter, receiver selectivity will be improved.

(1) FILTER CHARACTERISTICS

FILTER	MODE	CHARACTERISTICS		
		CENTER FREQ.	-6 dB POINT	-60 dB POINT
FL-53A	CW	455 kHz	250 Hz	480 Hz
FL-101	CW	9.0106 MHz	250 Hz	800 Hz
FL-102	AM	9.0100 MHz	6 kHz	20 kHz

(2) FL-53A INSTALLATION

- 1) Insert the filter in the proper position. No solder is necessary. (See the diagram below.)
- 2) Set S7 on the MAIN unit in the vertical position as shown in the diagram below.

(3) FL-101 INSTALLATION

- 1) Insert the filter in the proper position. No solder is necessary. (See the diagram below.)
- 2) Set S4 on the MAIN unit in the vertical position as shown in the diagram below.

(4) FL-102 INSTALLATION

- 1) Insert the filter in the proper position. No solder is necessary. (See the diagram below.)
- 2) Set S5 on the MAIN unit in the vertical position as shown in the diagram below.

(5) INSTALLATION LOCATIONS

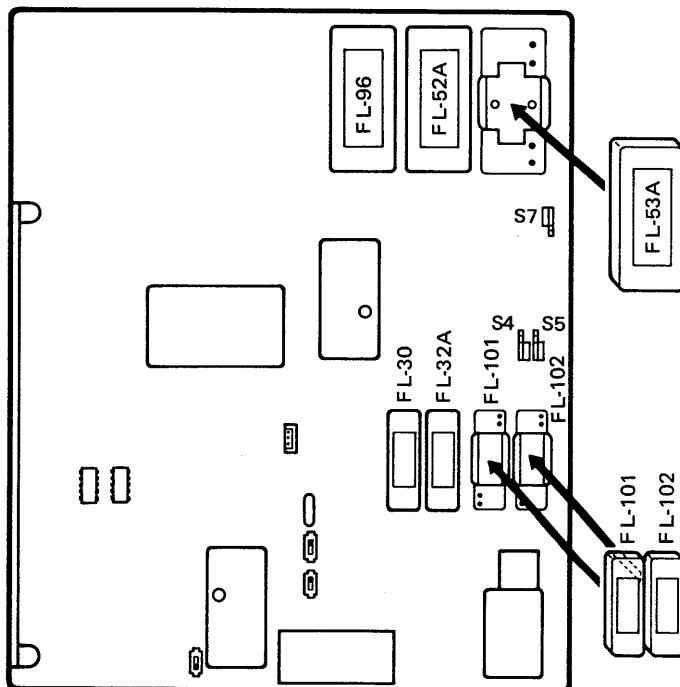

FILTER	SWITCH
FL-53A	S7
FL-101	S4
FL-102	S5

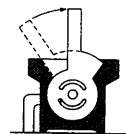

When an optional filter is installed, set each switch corresponding to each filter in the vertical position.

13 INSIDE VIEWS

13-1 TOP VIEW

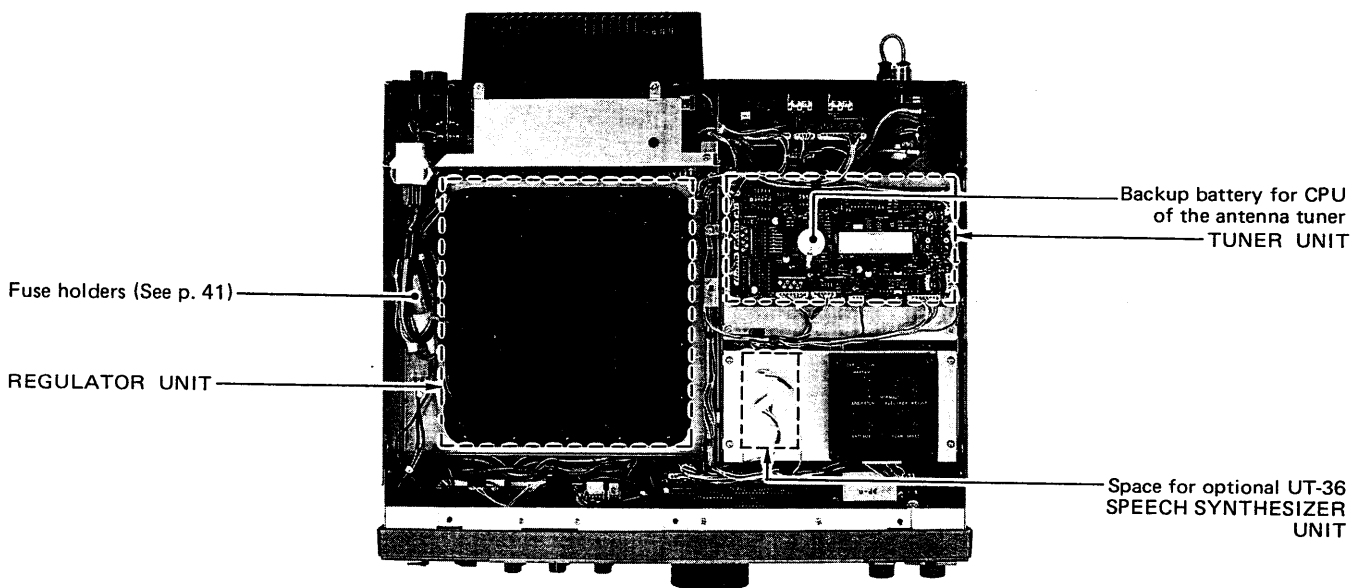
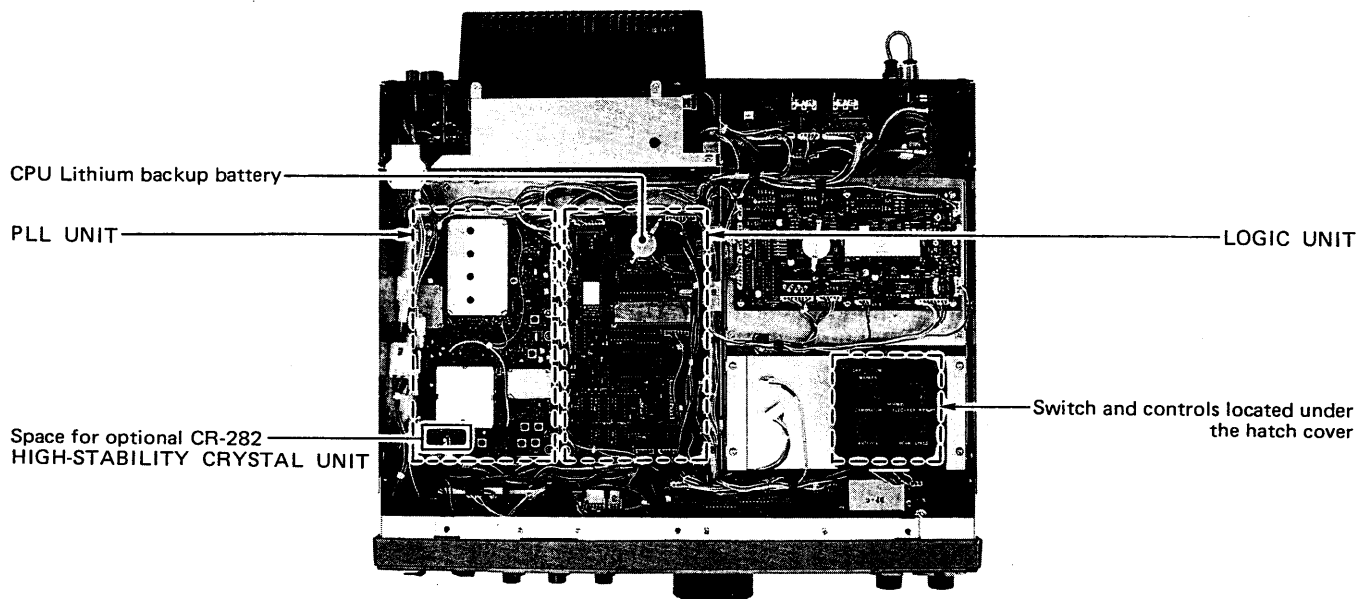

13-2 BOTTOM VIEW

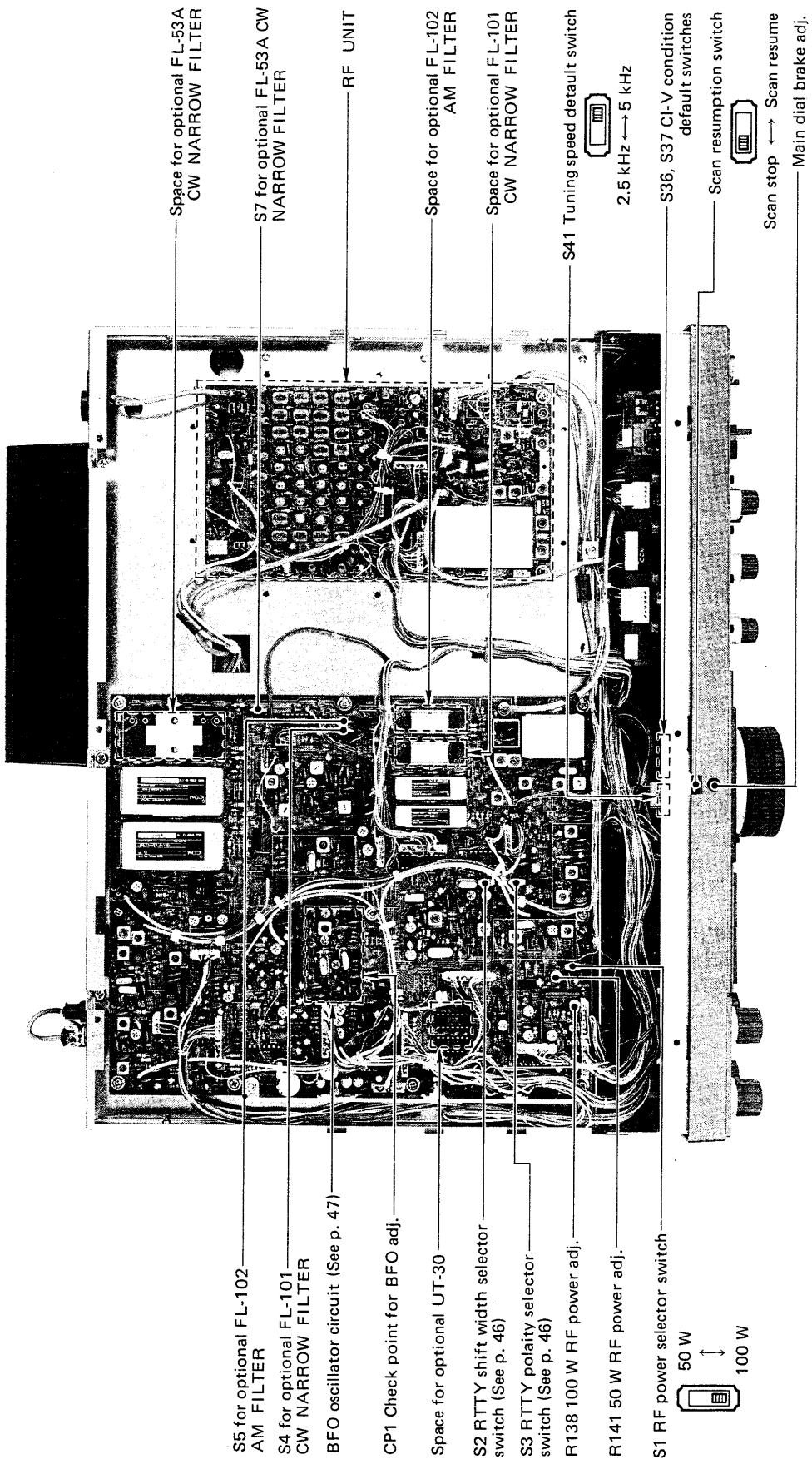

14 SPECIFICATIONS

■ GENERAL

• Frequency coverage :

Receive	0.1 ~ 30.0 MHz		
Transmit	160-m band	1.8	~ 2.0 MHz
	80-m band	3.5	~ 4.0 MHz
	40-m band	7.0	~ 7.3 MHz
	30-m band	10.1	~ 10.15 MHz
	20-m band	14.0	~ 14.35 MHz
	17-m band	18.068	~ 18.168 MHz
	15-m band	21.0	~ 21.45 MHz
12-m band	24.89	~ 24.99 MHz	
10-m band	28.0	~ 29.7 MHz	

• Modes :

LSB, USB, CW, AM, FM, RTTY

• Power supply requirement :

U.S.A. version	100 ~ 120 V AC
Australia, Europe, France versions	220 ~ 240 V AC

• Antenna impedance :

50 Ω (when the tuner switch is OFF)
16.5 ~ 150 Ω (when the tuner switch is ON)

• Power consumption :

Receive max. audio	80 VA (at 100 V AC)
	standby 75 VA (at 100 V AC)
Transmitting max.	650 VA (at 100 V AC)
	min. 250 VA (at 100 V AC)

• Usable temperature range :

-10°C ~ +60°C (+14°F ~ +140°F)

• Frequency stability :

- Less than ± 200 Hz under normal conditions (up to 1 hour after power is turned ON for 1 minute)
- Less than ± 30 Hz after every hour
- Less than ± 350 Hz at 0°C ~ +50°C (+32°F ~ +122°F)
- Less than ± 100 Hz when the optional CR-282 is installed

• Dimensions :

424(W) x 150(H) x 390(D) mm
16.7(W) x 5.9(H) x 15.4(D) in
(projections not included)

• Weight :

17.5 kg (38.6 lb)

■ TRANSMITTER

• Max. output power :

SSB	100 W PEP
CW, RTTY, FM	100 W
AM	40 W

• Modulation :

SSB	Balanced modulation
FM	Variable reactance modulation
AM	Low level modulation

• FM maximum deviation :

± 5 kHz

• RTTY shift width :

170 Hz, 850 Hz

• Spurious emissions :

More than 60 dB below peak output power

• Carrier suppression :

More than 40 dB below peak output power

• Unwanted sideband :

More than 55 dB (with 1 kHz modulation)

• Microphone impedance :

600 Ω

• Δ TX variable range :

± 9.99 kHz

■ RECEIVER

- Receive system :
SSB, CW, RTTY, AM Quadruple-conversion superheterodyne
FM Triple-conversion superheterodyne

- Intermediate frequencies :

	SSB	CW, RTTY	AM	FM
1st	69.0115 MHz	69.0106 MHz	69.0100 MHz	69.0100 MHz
2nd	9.0115 MHz	9.0106 MHz	9.0100 MHz	9.0100 MHz
3rd	455 kHz	455 kHz	455 kHz	455 kHz
4th	9.0115 MHz	9.0106 MHz	9.0100 MHz	-----

- Sensitivity (Preamp switch is ON) :
SSB, CW, RTTY (for 10 dB S/N)
0.1 ~ 0.5 MHz Less than 0.7 μ V
0.5 ~ 1.8 MHz Less than 1.0 μ V
1.8 ~ 30 MHz Less than 0.15 μ V
AM narrow (for 10 dB S/N)
0.1 ~ 0.5 MHz Less than 4.4 μ V
0.5 ~ 1.8 MHz Less than 6.3 μ V
1.8 ~ 30 MHz Less than 1.0 μ V
FM (for 12 dB SINAD)
28 ~ 30 MHz Less than 0.3 μ V

- FM squelch sensitivity :
28 ~ 30 MHz Less than 0.3 μ V

- Selectivity (IF shift is OFF) :
SSB More than 2.2 kHz/-6 dB
 Less than 4.2 kHz/-60 dB
CW, RTTY More than 500 Hz/-6 dB
 Less than 1.0 kHz/-60 dB
AM More than 6.0 kHz/-6 dB
 Less than 18.0 kHz/-50 dB
FM More than 15.0 kHz/-6 dB
 Less than 30 kHz/-50 dB

- Spurious rejection :
- Image frequencies More than 80 dB
- Intermediate frequencies More than 70 dB

- Audio output power :
More than 2.6 W at 10% distortion with an 8 Ω load

- Audio output impedance :
8 Ω

- RIT variable range :
 \pm 9.99 kHz

■ ANTENNA TUNER

- Output matching range :
16.7 ~ 150 Ω unbalanced (when the tuner switch is ON)
- Auto tuning accuracy :
VSWR 1.2 : 1 or less

All stated specifications are subject to change without notice or obligation.

15 OPTIONS

IC-4KL HF 1 kW LINEAR AMPLIFIER

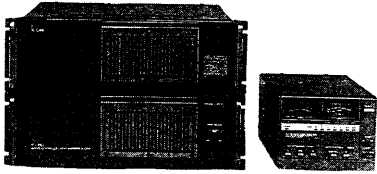

This is an all solid-state 1 kW linear amplifier. The amplifier is separated with the remote controller unit and power amplifier/power supply unit.

SP-20 EXTERNAL SPEAKER WITH AUDIO FILTERS

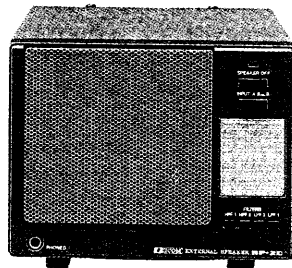

An external speaker with audio filters. Received audio quality can be changed with the filters. Size and style match the IC-765.

AH-2 HF AUTOMATIC ANTENNA TUNER

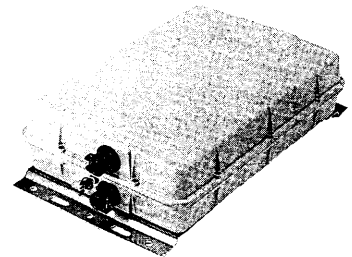

Matches the IC-765 to a long wire antenna system.

- Input power rating : 120 W

SM-8 DESKTOP MICROPHONE

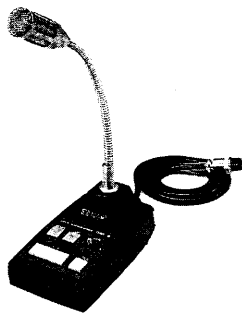

UP/DOWN switches included. Can be connected to 2 transceivers.

SM-6 DESKTOP MICROPHONE

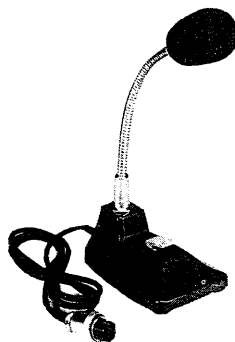

Easy-to-use goose-neck microphone. Suitable for base station operation.

HP-2 COMMUNICATION HEADPHONES



Provides clean audio and privacy in noisy environments.

UT-36 VOICE SYNTHESIZER UNIT



Announces the displayed frequency or operating mode in English or Japanese. Speech speed can be changed in 2 steps.

JT-30 PROGRAMMABLE TONE ENCODER UNIT

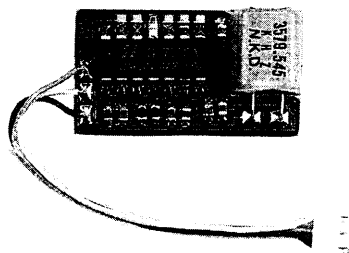

38 programmable tones available. Some repeaters require a superimposed tone when operating in FM mode through a repeater.

MB-19 RACK MOUNTING HANDLES

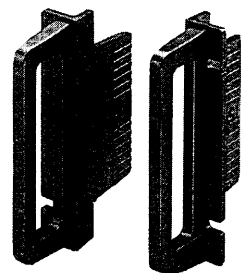

Mounting handles for 19-inch rack.

CT-16 SATELLITE INTERFACE UNIT



Easy tuning for instant satellite communications.

CT-17 CI-V LEVEL CONVERTER

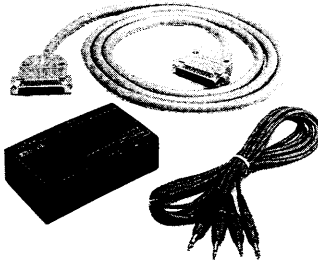

For remote transceiver control using a personal computer equipped with an RS-232C output port. You can change operating frequencies, memory channels, etc., with your computer keyboard.

EX-627 HF AUTOMATIC ANTENNA SELECTOR

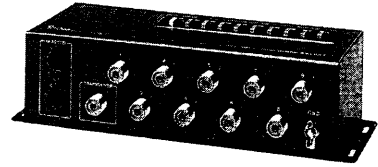

When connected to an Icom HF transceiver and up to 7 antennas, the EX-627 automatically selects the antenna for the band on which you are operating. (Manual selection is also possible.)

CR-282 HIGH-STABILITY CRYSTAL UNIT

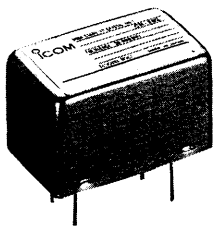

Contains a temperature-compensating oven heater and crystal unit for improved frequency stability.

- Frequency stability:
 ± 0.5 ppm. at $-30^{\circ}\text{C} \sim +60^{\circ}\text{C}$
 $(-22^{\circ}\text{F} \sim +140^{\circ}\text{F})$

9 MHz FILTERS

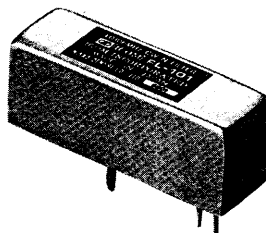

Have good shape factor and provide you with better receiver selectivity.

- FL-101 : 250 Hz/−6 dB (CW)
- FL-102 : 6 kHz/−6 dB (AM)

455 kHz FILTER

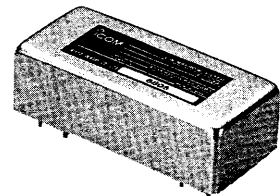

Has good shape factor and provides you with better receiver selectivity in CW mode.

- FL-53A : 250 Hz/−6 dB (CW)

